

Collection 2022-2023

AMISCO

Parfait pour vous
Your perfect fit

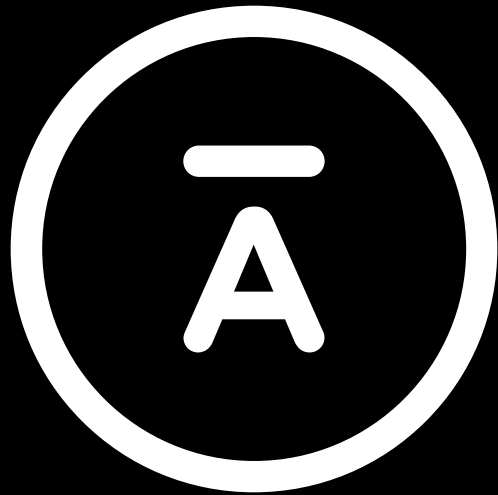





Contents Table des matières

Amisco : Your Perfect Fit <i>Amisco : Parfait pour vous</i>	7
The Team Behind the Brand <i>La marque d'une équipe</i>	8
Eco Amisco.....	10
Designer's Suggestions <i>Les suggestions du designer</i>	11
Trendy Furniture <i>Meubles tendance</i>	
Farmhouse.....	12
Urban.....	21
Nordic.....	68
Industrial.....	96
Boudoir.....	123
Countryside.....	145
Products and Specifications <i>Produits et spécifications</i>	150
Chairs and Stools <i>Chaises et tabourets</i>	151
Benches <i>Bancs</i>	208
Accent Furniture <i>Meubles d'accent</i>	213
Table Bases <i>Bases de table</i>	231
Zenith Table Bases <i>Bases de table Zenith</i>	309
Tabletops <i>Dessus de table</i>	313
Seating Capacity <i>Places assises</i>	325
Metal Finishes <i>Couleurs de métal</i>	326
Wood Colors <i>Couleurs de bois</i>	327
10 Year Warranty <i>Garantie 10 ans</i>	333
FAQ	334
Numerical Index <i>Index numérique</i>	340
Alphabetical Index <i>Index alphabétique</i>	353

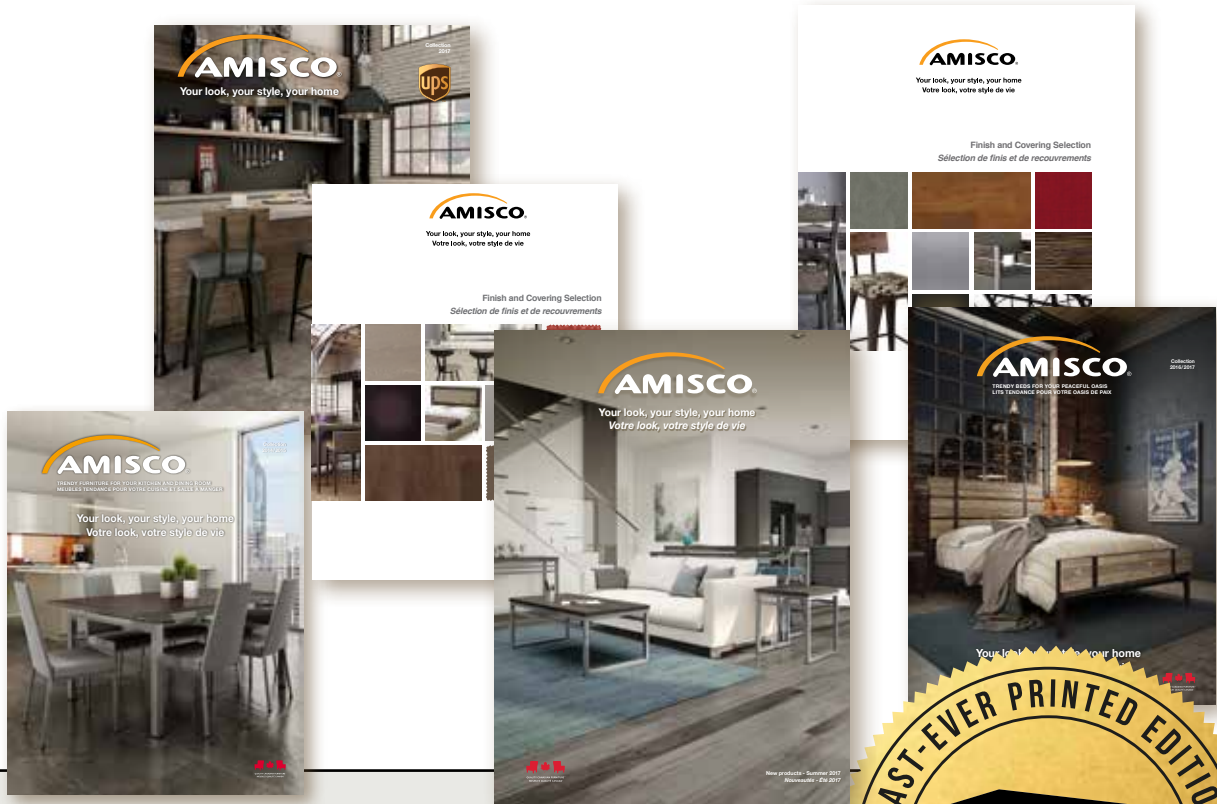

Amisco Catalogue Last-Ever Printed Edition

A page turns for the Amisco catalogue, as this edition will be the last-ever printed version.

With the aim to become more sustainable, to adapt to new modes of consumption and being aware that the printed catalog is gradually being less used in favor of our website, making this decision was usefself-evident. What has long been a source of inspiration and information for our retailers and customers will reinvent itself in new forms; the addition of new features to our online configurator, the increase of technical information available on product pages, the creation of inspiring content, and more. Amisco.com therefore becomes the source of choice to browse our product catalogue, discover new trends, and customize the piece of furniture of your dreams. We will continue to introduce many new products each year, guaranteeing you trendy and durable products and impeccable customer service!

One page after page, you'll see that Amisco is much more than furniture. Discover here all the products.



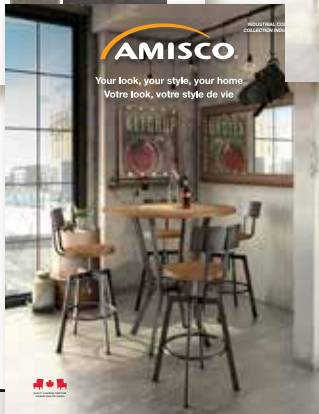
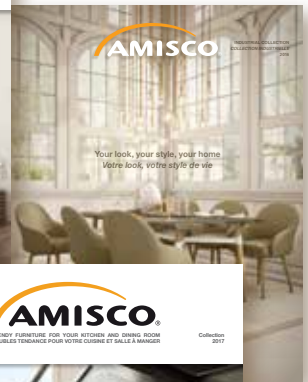
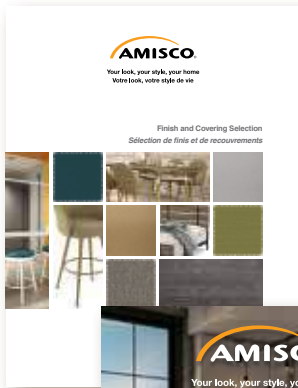

Catalogue Amisco Dernière édition imprimée

Une page se tourne pour le catalogue Amisco alors que cette édition sera la dernière version imprimée.

Dans le but de s'impliquer davantage pour l'environnement, de s'adapter aux nouveaux modes de consommation et étant conscients que le catalogue imprimé est peu à peu délaissé au profit de notre site web, prendre cette décision allait de soi. Ce qui a longtemps été une source d'inspiration et d'information pour nos détaillants et clients se réinventera sous de nouvelles formes; l'ajout de nouvelles fonctionnalités à notre configurateur en ligne, l'augmentation de l'information technique accessible sur les pages de produits, la création de contenu inspirant et plus encore. Amisco.com devient donc la source de choix pour parcourir notre catalogue de produits, s'inspirer des nouvelles tendances, et configurer le mobilier de vos rêves. Nous continuerons évidemment d'introduire de nombreuses nouveautés à chaque année, en vous garantissant des produits durables au style actuel et un service de qualité irréprochable!

Page après page, voyez comme Amisco c'est plus qu'un meuble. Découvrez ici tous nos produits.



CUSTOM MADE EASY



CONFIGURATION SIMPLIFIÉE



1

BROWSE / PARCOURIR

Browse our collections and select your chair, stool, table or accent furniture. / Parcourez nos collections et sélectionner votre chaise, tabouret, table ou meuble d'accent.

2

SELECT YOUR FINISHES / SÉLECTIONNEZ VOS FINIS

Change the color or finish of any material of your product in real time. / Changez la couleur ou le fini de n'importe quel matériau de votre produit en temps réel.



3

VIEW IN 3D / VISUALISEZ EN 3D

Zoom and rotate your customized product in any angle to see it in 3D. / Zoomez et tournez votre produit configuré dans n'importe quel angle pour le voir en 3D.

4

PLACE YOUR ORDER / PLACEZ VOTRE COMMANDE

Place your order with your Amisco retailer. / Placez votre commande auprès de votre détaillant Amisco.



SCAN TO START / BALAYER POUR COMMENCER

Scan the QR code to visit our website and use our online 3D furniture configurator / Balayer le code QR pour visiter notre site et utiliser notre configurateur 3D en ligne.



WWW.AMISCO.COM





Amisco : Your Perfect Fit

**Your perfect fit. It is more than a company signature :
it is a promise that Amisco makes to its clientele.**

To find exactly the design, quality and comfort desired. To be able to customize a product by selecting the perfect combination of finishes and covering.

The Amisco product is your perfect fit.

To rely on a company specialized in furniture for over 60 years to conceive, produce and distribute chairs, tables, stools and accent furniture from its two Canadian-based factories. To trust in an organization that works around the clock to constantly renew its product and finish offer in order to remain the leader of its industry when it comes to trendy furniture. **The Amisco expertise is your perfect fit.**

To make business with reliable professionals dedicated to quickly produce and deliver quality products meeting the strict expectations of the most demanding customers. **The Amisco experience is your perfect fit.**

To build a relationship with a respected, distinctive and flexible company, supported by a team of dedicated, accessible and efficient men and women, proud to provide customizable furniture to thousands of families across North America. **The Amisco brand is your perfect fit.**

Amisco : Parfait pour vous

**Parfait pour vous. C'est plus qu'une signature, c'est la
promesse qu'Amisco fait à sa clientèle.**

*Trouver exactement le design, la qualité et le confort recherchés. Pouvoir personnaliser son produit en choisissant la combinaison parfaite de finis et de recouvrement. **C'est la recette du produit parfait pour vous.***

*Pouvoir compter sur une entreprise spécialisée dans le meuble depuis plus de 60 ans pour concevoir, fabriquer et distribuer des chaises, tables, tabourets et meubles d'accent depuis ses deux usines canadiennes. Donner sa confiance à une organisation qui travaille sans relâche à renouveler son offre de produits et de finis pour demeurer la référence en matière de produits actuels dans son industrie. **C'est l'expertise parfaite pour vous.***

*Faire affaire avec des professionnels fiables dédiés à fabriquer et livrer rapidement des produits d'une grande qualité qui répondent aux besoins des consommateurs les plus exigeants. **C'est l'expérience client parfaite pour vous.***

*Miser sur l'expérience et la réputation d'une compagnie distinctive et agile employant une équipe d'hommes et de femmes engagés, accessibles, efficaces, et fiers de fournir des meubles personnalisables à des milliers de familles partout en Amérique du Nord. **C'est la marque parfaite pour vous.***

Réjean Poitras

President and Chief Executive Officer
Président et chef de la direction

The Team Behind the Brand

The Amisco brand is backed by a team dedicated to upholding our reputation for reliability and uncompromising quality and continuously improving our products and services. Employees readily share their passion, sense of innovation, and energy. As a result, each flawlessly designed Amisco piece is alluringly attractive and a pleasure to use. We are genuinely sincere about meeting your needs and exceeding your expectations, and committed to making you a loyal, fully satisfied customer. Because we want you to really love your Amisco furniture. So you'll be pleased to say, "I've finally found just the piece I needed for my décor!"



La marque d'une équipe

Derrière la marque Amisco, une équipe veille jalousement à la réputation de fiabilité, de qualité sans compromis et d'amélioration continue dans les produits et services. Leur passion, leur sens de l'innovation et leur dynamisme, les employés les partagent sans retenue. Ainsi, nos meubles séduisent par leur beauté, leur conception irréprochable et leur usage agréable. Tout cela en raison d'un engagement sincère à répondre aux besoins de nos clients et même à devancer leurs attentes. Parce que nous poursuivons une idée fixe: votre fidélité et votre entière satisfaction. Parce que nous voulons aussi que les meubles Amisco deviennent votre coup de foudre. Votre air de fierté! Enfin! Vous l'avez trouvé ce meuble que votre décor réclamait!





Planning Today for a Greener Tomorrow

When you acquire an Amisco piece, you are demonstrating your commitment to helping protect the environment. Our furniture is guaranteed to last, with durability and beauty that span generations. We use environmentally friendly processes, from the first phase of the manufacturing process until the last. We recycle production rejects. We avoid overpackaging and use packaging made from recycled and recyclable materials. Always concerned about limiting its environmental footprint, Amisco has completed and continues numerous initiatives to reduce its energy consumption.

Concevoir aujourd'hui pour demain

Acquérir un meuble Amisco est un signe d'engagement sur la voie écologique afin de protéger l'environnement. En effet, nos meubles portent le gage d'une longévité accrue puisque leur durabilité et leur beauté traversent les générations. De la première à la dernière étape de fabrication, nos procédés demeurent respectueux de l'environnement. Ainsi, nous recyclons nos rebuts de production. Nous évitons le suremballage et nous optons pour des emballages faits de matériaux recyclés et recyclables. Toujours dans un souci de limiter son empreinte environnementale, Amisco a réalisé et poursuit plusieurs projets de réduction de sa consommation d'énergie.

Eco Amisco



Designer's Suggestions

Les suggestions du designer



Looking for expert advice?

The line features a generous palette of finishes and coverings to work with. Which ones should you choose to achieve perfect harmony? Our designer is here to help, with her three top combinations for each trend.

Vous recherchez les conseils d'un expert?

Tous ces finis et recouvrements se déclinent en un éventail si généreux. Lesquels choisir pour un parfait équilibre? Heureusement, notre designer arrive à la rescousse. Pour chaque tendance, elle vous propose ses trois meilleures combinaisons.



Oxidado (52)
Oyster (DB)



Harley (51)
Sleet (BA)



Black coral/*Noir corail* (25)/
Clove (LB)

We provide the inspiration; you choose the look.
Laissez-vous inspirer. Le résultat vous ressemblera.

Farmhouse

THE AUTHENTIC FAMILY LIFE

Inspired by pretty country houses decorated with care and good taste, your home is a warm and welcoming place where your family loves to spend time as seasons go by. Solid wood, natural fiber textiles, family photos on the mantelpiece and this lovely antique in the room have just what it takes to add that authentic touch to your classic, soothing and timeless décor.

L'AUTHENTIQUE VIE DE FAMILLE

Inspiré des jolies maisons de campagne décorées avec soin et bon goût, votre intérieur est un endroit chaleureux et accueillant où toute la petite famille vit au fil des saisons. Le bois massif, les textiles faits de fibres naturelles, les photos de famille sur le manteau de la cheminée et cette petite antiquité dans la pièce contribuent à ajouter ce cachet authentique à votre décor classique, apaisant et intemporel.



DESIGNER'S SUGGESTIONS
LES SUGGESTIONS DU DESIGNER



Black coral / Noir corail (25)
Stone dust (89)



Harley (51) / Verdastrò (39)



Oxidado (52) / Sand dust (86)



Upright 30410

Bench / Banc

Colors shown / Couleurs montrées : Cobrizo (75) / Clove (LB) / Pine cone (96)

Pedro 35308

Chair / Chaise

Lexington 50535

Extendable table base / Base de table extensible

91493

Non-distressed solid wood tabletop (birch) -
38 1/8" x 72" with two 15" leaves
Dessus de table en bois massif non usé (merisier) -
38 1/8" x 72" avec deux rallonges de 15"



Bridget 40575-26

Non swivel stool / *Tabouret non pivotant*

Colors shown / *Couleurs montrées* : Oxidado (52) / —



Maddie 30341

Chair / Chaise

Colors shown/ Couleurs montrées : Black coral/ Noir corail (25)/ Sheep (JU)/ Verduzzu (AV)

Octavia 50578

Table base/ Base de table

93485

Solid wood tabletop (ash) - 40" x 84" /
Dessus de table en bois massif (frêne) - 40" x 84"



Mathilde 30340

Chair / Chaise

Colors shown / Couleurs montrées : Oxidado (52)/Complicity (KL)/Pine cone (96)

Parade 50566

Table base / Base de table

90487

Non-distressed solid wood tabletop (birch) - 40" x 72"
Dessus de table en bois massif non usé (merisier) -
40" x 72"



Mathilde 40340-26

Non swivel stool/Tabouret non pivotant

Colors shown/Couleurs montrées : Oxidado (52)/Complicity (KL)



Miller 40035-26

Non swivel stool / *Tabouret non pivotant*

Colors shown / *Couleurs montrées* : Oxidado (52) / Stratus (DD)



Dorsey 41596-26

Swivel stool / *Tabouret pivotant*

Colors shown / *Couleurs montrées* : Oxidado (52) / Shiitake (HT)



Collin 41234-26

Swivel stool with solid wood base (birch) / *Tabouret pivotant avec base en bois massif (merisier)*

Colors shown / *Couleurs montrées* : Tiramisu (47) / Biscuit (HO)

Urban

RESOLUTELY URBAN

You love curating your surroundings with a hipster look, a relaxed ambience, and the out of the ordinary. Gleaming metals, pure, flowing lines, and shiny surfaces call your name.

RÉSOLUMENT URBAIN

Vous aimez bien vous entourer. Le look branché. L'ambiance relax. Le singulier. Les métaux lumineux, les lignes fluides et épurées, les surfaces lisses vous interpellent.



DESIGNER'S SUGGESTIONS
LES SUGGESTIONS DU DESIGNER



Metallo (57)/Flame (HB)
Porter (44)



Magnetite (24)/Ink (DA)
Earl grey (48)



Titanium (56)/Stratus (DD)
Tiramisu (47)



Skyla 42344-26B

Swivel stool / *Tabouret pivotant*

Colors shown / *Couleurs montrées* : Black coral / *Noir corail* (25) / Cashew (46)



Otis 40347-26

Non swivel stool/ *Tabouret non pivotant*

Colors shown/ *Couleurs montrées* : Black coral/ *Noir corail* (25)/ Alpaca (LC)



Essie 30343

Chair / Chaise

Colors shown / Couleurs montrées : Black coral / Noir corail (25) / Iceberg (MB) / Basalt (30)

Zoel 51572

Table base / Base de table

90586

Thermo fused laminate (TFL) tabletop - 40" x 72" / Dessus de table en panneau laminé (TFL) - 40" x 72"



Costa 42463-26B

Swivel stool/ *Tabouret pivotant*

Costa 41563-26

Swivel stool/ *Tabouret pivotant*

Colors shown/ *Couleurs montrées* : Black coral/ *Noir corail* (25)/ Doodle (L8)/ Cashew (46)



Maya 50403

End table base / Base de table de bout

90815

Wood veneer tabletop (walnut) - 24" dia.
 Dessus de table en placage de bois (noyer) -
 24" dia.

Maya 50404

Coffee table base 17" H / Base de table à café 17" H

90818

Wood veneer tabletop (walnut) - 36" dia.
 Dessus de table en placage de bois (noyer) -
 36" dia.

Maya 50406

Coffee table base 13" H / Base de table à café 13" H

90524

Thermo fused laminate (TFL) tabletop - 24" dia.
 Dessus de table en panneau laminé (TFL) -
 24" dia.

Colors shown / Couleurs montrées : Black coral / Noir corail (25) / Basalt (30) / Pine cone (96)



Skyla 42344-26

Swivel stool/ *Tabouret pivotant*

Colors shown/ *Couleurs montrées* : Black coral/ *Noir corail (25)*/ Camel (MC)



Glint 42495-30

Swivel stool / *Tabouret pivotant*

Colors shown / *Couleurs montrées* : Magnetite (24) / Blizzard (DH)



Sonoma 40355-26

Non swivel stool / *Tabouret non pivotant*

Colors shown / *Couleurs montrées* : Sun gold (27) / Blizzard (DH)



Gladys 30337

Chair / Chaise

Burton 50557

Table base / Base de table

90586

Thermo fused laminate (TFL) tabletop - 40" x 72"
Dessus de table en panneau laminé (TFL) - 40" x 72"

Colors shown / Couleurs montrées : Titanium (56)/ Sheep (JU)/ Auburn (28)



Linea 41321-26

Swivel stool / *Tabouret pivotant*

Colors shown / *Couleurs montrées* : Pure (61) / Breezy (JS)



Jill 50262

End table base / *Base de table de bout*

90245

Clear glass tabletop - 19 1/2" x 19 1/2"
Dessus de table en verre clair - 19 1/2" x 19 1/2"

Color shown / *Couleur montrée* : Titanium (56)

Jill 50362

Coffee table base / *Base de table à café*

90248

Clear glass tabletop - 28" x 48"
Dessus de table en verre clair - 28" x 48"



Lincoln 41478-26

Swivel stool / *Tabouret pivotant*

Colors shown / *Couleurs montrées* : Magnetite (24) / Blizzard (DH)



Bray 41333-26

Swivel stool / *Tabouret pivotant*

Colors shown / *Couleurs montrées* : Black coral / *Noir corail* (25) / —
Black leather / *Cuir noir* (0B)



Osten 30331

Chair / Chaise

Colors shown / Couleurs montrées : Black coral / Noir corail (25) / Boardwalk (KX) / Interlink (JP) / Mouse (49) / Basalt (30)

Zenith 52560

Extendable table base / Base de table extensible

92801

Wood veneer tabletop (birch) - 36" x 60" with a 23 3/4" thermo fused laminate (TFL) butterfly leaf
Dessus de table en placage de bois (merisier) - 36" x 60" avec une rallonge papillon de 23 3/4" en panneau laminé (TFL)



Osten 40331-26

Non swivel stool / *Tabouret non pivotant*

Colors shown / *Couleurs montrées* : Metallo (57) / Limestone (EV)



Bray 30333

Chair / Chaise

Colors shown / Couleurs montrées : Black coral / Noir corail (25) / Illusion (KO) / Black leather / Cuir noir (OB)

Lidya 50972

Table base / Base de table

90271

Clear glass tabletop - 39 1/2" x 71 1/2"
Dessus de table en verre clair - 39 1/2" x 71 1/2"



Zola 30342

Chair / Chaise

Colors shown / Couleurs montrées : Black coral / Noir corail (25)
Tuxedo (30) / Basalt (30)

Azilis 50665

Table base / Base de table

90554

Thermo fused laminate (TFL) tabletop - 32" x 54"
Dessus de table en panneau laminé (TFL) - 32" x 54"



Osten 30331

Chair / Chaise

Colors shown / Couleurs montrées : Metallo (57) / Darkness (EU) / Concrete (34)

Zoom 50522

Table base / Base de table

90591

Thermo fused laminate (TFL) tabletop - 38" x 60" with two 15" leaves
Dessus de table en panneau laminé (TFL) - 38" x 60" avec deux rallonges de 15"



Luna 30317

Chair / Chaise

Color shown / Couleur montrée : Dayglam (53) / —

Bennington 50960

Table base / Base de table

90281

Ultra white glass tabletop - 39 1/2" x 71 1/2"
Dessus de table en verre ultra blanc - 39 1/2" x 71 1/2"



Zip 42334-26

Swivel stool / *Tabouret pivotant*

Color shown / *Couleur montrée* : Dayglam (53) / —



Phoebe 41571-26

Swivel stool / *Tabouret pivotant*

Color shown / *Couleur montrée* : Magnetite (24) / —

Aden 50537-38

Table base / *Base de table*

90039

Ultra white glass tabletop - 23 7/8" x 23 7/8"
Dessus de table en verre ultra blanc -
23 7/8" x 23 7/8"



Luna 40317-26

Non swivel stool / *Tabouret non pivotant*

Color shown / *Couleur montrée* : Dayglam (53) / –



Noah 41230-26

Swivel stool with solid wood base (birch) / *Tabouret pivotant avec base en bois massif (merisier)*

Colors shown / *Couleurs montrées* : Earl grey (48) / Cloud (HF)



Phoebe 30571

Chair / Chaise

Colors shown/ Couleurs montrées : Magnetite (24)/ —/Barley (A1)

Burton 50557

Table base / Base de table

93483

Solid wood tabletop (ash) - 40" x 72" with two 18" leaves
Dessus de table en bois massif (frêne) - 40" x 72" avec deux rallonges de 18"



Rudy 42442-26

Non swivel stool / *Tabouret non pivotant*

Crawford 50264

End table base / *Base de table de bout*

90882

Wood veneer tabletop (birch)
Dessus de table en placage de bois (merisier)

Crawford 50764

Coffee table base / *Base de table à café*

90887

Wood veneer tabletop (birch)
Dessus de table en placage de bois (merisier)

Colors shown / *Couleurs montrées* : Titanium (56) / Earl grey (48) / Shiitake (HT)



Hans 42504-26

Swivel stool / *Tabouret pivotant*

Color shown / *Couleur montrée* : Magnetite (24) / —



Crawford 50164

Console table base / Base de table console

90881

Wood veneer tabletop (birch)
Dessus de table en placage de bois (merisier)

Crawford 50264

End table base / Base de table de bout

90882

Wood veneer tabletop (birch)
Dessus de table en placage de bois (merisier)

Crawford 50364

Coffee table base / Base de table à café

90883

Wood veneer tabletop (birch)
Dessus de table en placage de bois (merisier)

Colors shown / Couleurs montrées : Magnetite (24) / Earl grey (48)



Easton 30535

Chair / Chaise

Colors shown / Couleurs montrées : Black coral / Noir corail (25) / Pixel (BP) / Versailles (BQ) / Earl grey (48)

Hendrick 50532

Table base / Base de table

90893

Wood veneer tabletop (birch) - 38" x 72" with a 24" butterfly leaf
Dessus de table en placage de bois (merisier) - 38" x 72" avec rallonge papillon de 24"



Zola 40342-26

Non swivel stool / *Tabouret non pivotant*

Colors shown / *Couleurs montrées* : Black coral / *Noir corail* (25) / Tuxedo (JQ)



Monroe 35404

Chair / Chaise

Melrose 35408

Chair / Chaise

Monroe 30474

Bench / Banc

Richview 50531

Table base / Base de table

Colors shown / Couleurs montrées : Titanium (56) / Slate (HD) / Flame (HB) / Earl grey (48)

90895

Wood veneer tabletop (birch) - 38" x 72" with a 24" butterfly leaf
Dessus de table en placage de bois (merisier) - 38" x 72" avec rallonge papillon de 24"



Brock 41435-30

Swivel stool / *Tabouret pivotant*

Colors shown / *Couleurs montrées* : Magnetite (24) / Blizzard (DH)



Aaron 40039-26

Non swivel stool/ *Tabouret non pivotant*

Colors shown/ *Couleurs montrées* : Magnetite (24)/Pixel (BP)

Harrison 50968-36

Table base/ *Base de table*

90268

Mat black glass tabletop - 28" x 48"
Dessus de table en verre noir mat - 28" x 48"



Sorrento 30539

Swivel chair / *Chaise pivotante*

Colors shown / *Couleurs montrées* : Magnetite (24)/Pure (61)/Flame (HB)

Link 50953

Table base / *Base de table*

90273

Clear glass tabletop - 39 1/2" x 83 1/2"
Dessus de table en verre clair - 39 1/2" x 83 1/2"



Positano 41569-26

Swivel stool/ *Tabouret pivotant*

Colors shown/ *Couleurs montrées* : Magnetite (24)/Ink (DA)



Easton 41535-26

Swivel stool / *Tabouret pivotant*

Color shown / *Couleur montrée* : Magnetite (24) / –



Sorrento 41539-26

Swivel stool/ *Tabouret pivotant*

Colors shown/ *Couleurs montrées* : Magnetite (24)/Flame (HB)



Owen 30154

Chair / Chaise

Colors shown / Couleurs montrées : Magnetite (24) / — / Earl grey (48)

Zoom 50522

Table base / Base de table

90891

Wood veneer tabletop (birch) - 38 1/8" x 60"
with two 15" leaves
Dessus de table en placage de bois (merisier) -
38 1/8" x 60" avec deux rallonges de 15"



Easton 30535

Chair / Chaise

Dryden 30419

Bench / Banc

Burton 50557

Table base / Base de table

Colors shown / Couleurs montrées : Magnetite (24) / — / Toasty (87)

90485

Distressed solid wood tabletop (birch) - 40" x 84"
Dessus de table en bois massif usé (merisier) -
40" x 84"



Linea 41320-26

Swivel stool / *Tabouret pivotant*

Color shown / *Couleur montrée* : Magnetite (24) / —



Level 41325-26

Swivel stool/ *Tabouret pivotant*

Colors shown/ *Couleurs montrées* : Magnetite (24)/Blizzard (DH)



Nathan 40033-26

Non swivel stool / *Tabouret non pivotant*

Bryce 41444-26

Swivel stool / *Tabouret pivotant*

Barry 41445-26

Swivel stool / *Tabouret pivotant*

Color shown / *Couleur montrée* : — / —



Linea 30320

Chair / Chaise

Colors shown / Couleurs montrées : Magnetite (24) / — / Earl grey (48)

Zoom 50522

Table base / Base de table

90891

Wood veneer tabletop (birch) - 38 1/8" x 60"
with two 15" leaves
Dessus de table en placage de bois (merisier) -
38 1/8" x 60" avec deux rallonges de 15"



Fred 40044-26

Non swivel stool / *Tabouret non pivotant*

Colors shown / *Couleurs montrées* : Black coral / *Noir corail* (25) / Aztec (EZ) / Pine cone (96)

Azilis 50665-36

Table base / *Base de table*

90846

Wood veneer tabletop (walnut) - 32" x 54"
Dessus de table en placage de bois (noyer) - 32" x 54"



Ronny 41442-26

Swivel stool/ *Tabouret pivotant*

Colors shown/ *Couleurs montrées* : Metallo (57)/Oyster (DB)



Anton 42231-26

Swivel stool with solid wood base (birch) / *Tabouret pivotant avec base en bois massif (merisier)*

Colors shown / *Couleurs montrées* : Pine cone (96) / Marshmallow (DX)



Curve 30321

Chair / Chaise

Colors shown / Couleurs montrées : Magnetite (24) / Oyster (DB) / Tiramisu (47)

Nexus 50524

Table base / Base de table

90892

Wood veneer tabletop (walnut) - 38 1/8" x 60"
with two 15" leaves
Dessus de table en placage de bois (noyer) -
38 1/8" x 60" avec deux rallonges de 15"

Nordic

LIVING BETTER TOGETHER

Get into the Scandinavian mindset! Picture it: you live together in a white interior with pale wood, little hints of color, clean lines, soft materials, and minimalist geometric accents. The space welcomes people as they come and go. It's airy, open, and full of natural light. You feel connected with nature and would happily spend hours together just being in the space. Everything is so cozy you and your family can just curl up anywhere. So clear your mind, relax, and just enjoy living together.

MIEUX VIVRE ENSEMBLE

Bienvenue dans l'esprit scandinave! Ici, c'est le règne du blanc, du bois blond, de la couleur en petites touches, des lignes pures, des matières douces et des motifs géométriques en parcimonie. On humanise l'espace. On lui donne du souffle. On invite la lumière. On se connecte avec la nature. On y coule des heures agréables. On se love dans tout ce qui est douillet. On se vide la tête. On relaxe... enfin! On aime vivre ensemble.



DESIGNER'S SUGGESTIONS
LES SUGGESTIONS DU DESIGNER



Black coral / Noir corail (25)
Licorice (EP) / Pine cone (96)



Oxidado (52)
Caramelo (ER) / Tiramisu (47)



Metallo (57) / Pixel (BP)
Earl grey (48)



Nestor 30348

Chair / Chaise

Colors shown / Couleurs montrées : Black coral / Noir corail (25) / Camel (MC) / Barrel (A3)

Bennington 50660

Table base / Base de table

93487

Solid wood tabletop (ash) - 40" x 72"
Dessus de table en bois massif (frêne) - 40" x 72"



Nestor 40348-26

Non swivel stool / *Tabouret non pivotant*

Colors shown / *Couleurs montrées* : Black coral / *Noir corail* (25) / Camel (MC)



Benson 30336

Chair / Chaise

Tayra 50998

Table base / Base de table

90585

Thermo fused laminate (TFL) tabletop - 40" x 84"
Dessus de table en panneau laminé (TFL) - 40" x 84"

Colors shown / Couleurs montrées : Black coral / Noir corail (25) / Merino (JT) / Basalt (30)



Zahra 30334

Chair / Chaise

Colors shown / Couleurs montrées : Sun gold (27) / Stellar (JR)

Benson 30446

Bench / Banc

Lidya 50972

Table base / Base de table

90271

Clear glass tabletop - 39 1/2" x 71 1/2"
Dessus de table en verre clair - 39 1/2" x 71 1/2"



Benson 41336-26

Swivel stool / *Tabouret pivotant*

Colors shown / *Couleurs montrées* : Black coral / *Noir corail (25)* / Parchment (GT)



Zao 41219-26

Swivel stool with solid wood legs (birch) and metal footrest / *Tabouret pivotant avec pattes en bois massif (merisier) et appui-pied en métal*

Colors shown / *Couleurs montrées* : Black coral / *Noir corail* (25) / Interlink (JP) / Pine cone (96)



Outback 40336-26

Non swivel stool / *Tabouret non pivotant*

Color shown / *Couleur montrée* : Pure (61) / —



Visconti 41253-26

Swivel stool with solid wood legs (birch) and metal footrest / *Tabouret pivotant avec pattes en bois massif (merisier) et appui-pied en métal*

Colors shown / *Couleurs montrées* : Black coral / *Noir corail* (25) / Boardwalk (KX) / Cashew (46)



Fletcher 41212-26

Swivel stool with solid wood legs (birch) and metal footrest / *Tabouret pivotant avec pattes en bois massif (merisier) et appui-pied en métal*

Colors shown / *Couleurs montrées* : Black coral / *Noir corail* (25) / Pixel (BP) / Café (43)



Zahra 41334-26

Swivel stool / *Tabouret pivotant*

Colors shown / *Couleurs montrées* : Black coral / *Noir corail* (25) / Pixel (BP)



Zahra 30334

Chair / Chaise

Colors shown / Couleurs montrées : Black coral / Noir corail (25) / Pixel (BP) / Earl grey (48)

Hendrick 50532

Table base / Base de table

90895

Wood veneer tabletop (birch) - 38" x 72" with a 24" butterfly leaf
Dessus de table en placage de bois (merisier) - 38" x 72" avec rallonge papillon de 24"



Waverly 40353-26

Non swivel stool / *Tabouret non pivotant*

Colors shown / *Couleurs montrées* : Titanium (56) / Stratus (DD)



Waverly 30353

Chair / Chaise

Colors shown / Couleurs montrées : Titanium (S6) / River (HK) / Ashes (A9)

Burton 50557

Table base / Base de table

93472

Solid wood tabletop (ash) - 38" x 72"
Dessus de table en bois massif (frêne) - 38" x 72"



Zuma 50161-14

Coffee table base / Base de table à café

90530

Thermo fused laminate (TFL) tabletop
Dessus de table de panneau laminé

Black coral / Noir corail (25) / Concrete (34)

90833

Wood veneer (walnut) tabletop with ottoman
Dessus de table en placage de bois (noyer) avec
repose-pieds

Colors shown / Couleurs montrées : Black coral / Noir
corail (25) / Pine cone (96) / Interlink (JP)

Zuma 50161-20

End table base / Base de table de bout

90832

Wood veneer (walnut) / Placage de bois (noyer)

Colors shown / Couleurs montrées : Black coral / Noir
corail (25) / Pine cone (96)

Zuma 50461

C table base / Base de table en C

90530

Thermo fused laminate (TFL) tabletop
Dessus de table de panneau laminé

Colors shown / Couleurs montrées : Black coral / Noir
corail (25) / Basalt (30)



Webber 30330

Chair / Chaise

Colors shown / Couleurs montrées : Sun gold (27) / Cerulean (JK) / Pine cone (96)

Link 50555

Table base / Base de table

90858

Wood veneer tabletop (walnut) - 48" dia.
Dessus de table en placage de bois (noyer) - 48" dia.



Bellamy 40354-26

Non swivel stool / *Tabouret non pivotant*

Colors shown / *Couleurs montrées* : Black coral / *Noir corail* (25) / Oceanic (JM)



Bellamy 30354

Chair / Chaise

Colors shown / Couleurs montrées : Black coral / Noir corail (25) / Oceanic (JM) / Basalt (30)

Richview 50531

Table base / Base de table

90592

Thermo fused laminate (TFL) tabletop - 38" x 72" with a 24" butterfly leaf
Dessus de table en panneau laminé (TFL) - 38" x 72" avec rallonge papillon de 24"



Joshua 41239-26

Swivel stool with solid wood base (birch)/ *Tabouret pivotant avec base en bois massif (merisier)*

Color shown/ *Couleur montrée* : Pine cone (96)/ –



Wilbur 41570-26

Swivel stool / *Tabouret pivotant*

Colors shown / *Couleurs montrées* : Oxidado (52) / Cactus (KE)



Wilbur 30570

Chair / Chaise

Colors shown / Couleurs montrées : Oxidado (52) / Cactus (KE) / Tiramisu (47)

Wilbur 41570-26

Swivel stool / Tabouret pivotant

Richview 50531

Table base / Base de table

90894

Wood veneer tabletop (walnut) -
38" x 72" with a 24" butterfly leaf
Dessus de table en placage de bois (noyer) -
38" x 72" avec rallonge papillon de 24"



Hint 40202-26

Non swivel stool / *Tabouret non pivotant*

Colors shown / *Couleurs montrées* : Oxidado (52) / Caramelo (ER) / Tiramisu (47)



Nox 42534-26

Swivel stool / *Tabouret pivotant*

Color shown / *Couleur montrée* : Titanium (56) / —



Grissom 41560-26

Swivel stool / *Tabouret pivotant*

Colors shown / *Couleurs montrées* : Black coral / *Noir corail (25)* / Cemento (EL)



Hint 30202

Chair / Chaise

Colors shown / Couleurs montrées : Oxidado (52) / Caramelo (ER) / Tiramisu (47)

Richview 50531

Table base / Base de table

90894

Wood veneer tabletop (walnut) –
38" x 72" with a 24" butterfly leaf
Dessus de table en placage de bois (noyer) –
38" x 72" avec rallonge papillon de 24"



Carson 41519-26

Swivel stool / *Tabouret pivotant*

Colors shown / *Couleurs montrées* : Black coral / *Noir corail* (25) / Licorice (EP) / Pine cone (96)



Grissom Plus 30561

Chair / Chaise

Grissom 30560

Chair / Chaise

Boomerang 50533

Table base / Base de table

Colors shown / Couleurs montrées : Black coral / Noir corail (25) / Volcano (CP) / Cemento (EL) / Pine cone (96)

90896

Wood veneer tabletop (walnut) - 38" x 72" with a 24" butterfly leaf
 Dessus de table en placage de bois (noyer) - 38" x 72" avec rallonge papillon de 24"



Button 42460-26

Swivel stool / *Tabouret pivotant*

Colors shown / *Couleurs montrées* : Titanium (56) / Pebble (CB)

Industrial

RAW BEAUTY

Inspired by factories from the industrial era-influenced by a modern touch, your home embraces mixed raw materials. Concrete, matte metal, distressed wood, worn bricks. For sure your décor has a story to tell.

BEAUTÉ À L'ÉTAT BRUT

Tirant son inspiration des usines de l'époque de la révolution industrielle, mais avec une touche de renouveau, votre décor fait l'éloge d'un amalgame de matériaux bruts. Ciment, métaux mats, bois rustique, briques usées. Comme si votre intérieur avait une histoire à partager.

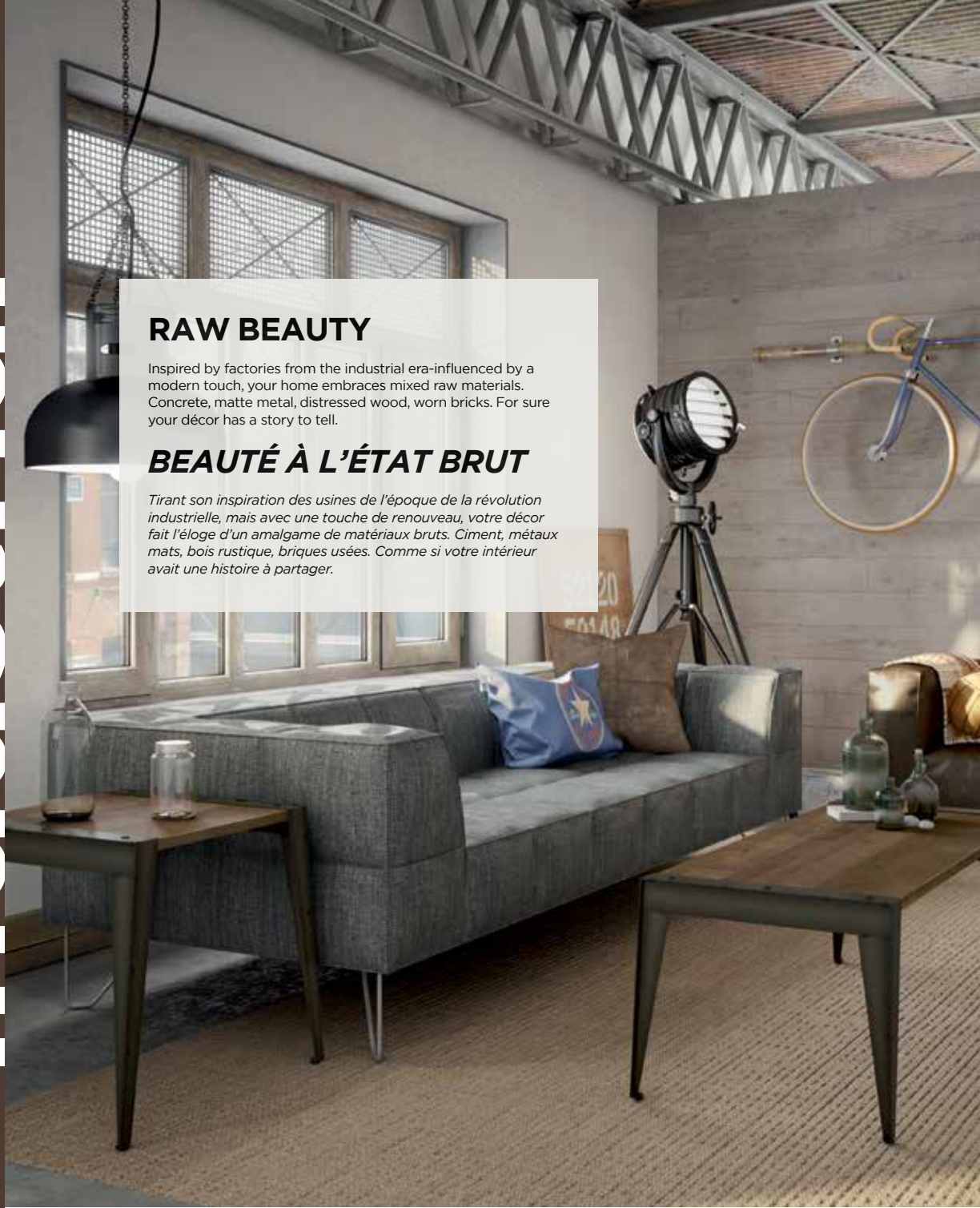

DESIGNER'S SUGGESTIONS
LES SUGGESTIONS DU DESIGNER



Harley (51)/Elephant (DN)
Stone dust (89)



Oxidado (52)/Biscuit (HO)
Sand dust (86)



Black coral/Noir corail (25)
Coal (HC)/Toasty (87)



Esteban 41273-26B

Swivel stool with solid wood legs (birch) and metal footrest/ *Tabouret pivotant avec pattes en bois massif (merisier) et appui-pied en métal*

Colors shown/ *Couleurs montrées* : Harley (51)/Tiramisu (47)



Pedro 35308

Chair / Chaise

Parade 50559

Table base / Base de table

91462

Solid wood tabletop (birch) - 36" x 60"
Dessus de table en bois massif (merisier) - 36" x 60"

Colors shown / Couleurs montrées : Black coral / Noir corail (25) / Aztec (EZ) / Cashew (46)



Owen 30154

Chair / Chaise

Merlot 30322

Chair / Chaise

Alexis 50683

Table base / Base de table

Colors shown / Couleurs montrées : Harley (51) / Complicity (KL) / Sand dust (86)

91462

Distressed solid wood tabletop (birch) - 36" x 60"
Dessus de table en bois massif usé (merisier) -
36" x 60"



Upright 42564-26B

Non swivel stool
Tabouret non pivotant

Elwood 50165

Console table base
Base de table console

90491

Distressed solid wood tabletop (birch)
Dessus de table en bois massif usé
(merisier)

Elwood 50265

End table base
Base de table de bout

90492

Distressed solid wood tabletop (birch)
Dessus de table en bois massif usé
(merisier)

Elwood 50765

Living room island base (long version)
Base d'îlot de salon (version longue)

90497

Distressed solid wood top and shelf
(birch)
Dessus et tablette en bois massif usé
(merisier)



Ethan Plus 45309-26

Non swivel stool/Tabouret non pivotant

Colors shown/Couleurs montrées : Metallo (57)/—/—/Anthracite (A6)

Bennington 50660-36

Table base/Base de table

93487

Solid wood tabletop (ash) - 40" x 72"
Dessus de table en bois massif (frêne) -
40" x 72"



Elwood 50165

Console table base / Base de table console

90491

Distressed solid wood tabletop (birch)
Dessus de table en bois massif usé
(merisier)

Elwood 50265

End table base / Base de table de bout

90492

Distressed solid wood tabletop (birch)
Dessus de table en bois massif usé
(merisier)

Elwood 50365

Coffee table base / Base de table à café

90493

Distressed solid wood tabletop (birch)
Dessus de table en bois massif usé
(merisier)

Elwood 50765

Living room island base (long version)
Base d'îlot de salon (version longue)

90497

Distressed solid wood top and shelf
(birch)
Dessus et tablette en bois massif usé
(merisier)



Architect 30263

Chair / Chaise

Colors shown / Couleurs montrées : Oxidado (52) / — / Roasted (HV) / Milk (80)

Architect 30273

Bench / Banc

Southcross 50567

Table base / Base de table

90484

Distressed solid wood tabletop with decorative bolts (birch) - 40" x 84"
 Dessus de table en bois massif usé avec vis décoratives (merisier) - 40" x 84"



Architect 30563

Chair / Chaise

Colors shown / Couleurs montrées : Harley (51)/Elephant (DN)/Stone dust (89)

Southcross 50567

Table base / Base de table

90480

Distressed solid wood tabletop with decorative bolts (birch) - 40" x 84" with two 18" leaves
Dessus de table en bois massif usé avec vis décoratives (merisier) - 40" x 84" avec deux rallonges de 18"



Pablo 35304

Chair / Chaise

Colors shown / Couleurs montrées : Black coral / Noir corail (25) / — / Tahoe (ES) / Pretzel (93)

Alto 35309

Chair / Chaise

Pablo 30473

Bench / Banc

Tacoma 50516

Table base / Base de table

90465

Distressed solid wood tabletop (birch) - 38 1/8" x 60" with one 15" leaf
 Dessus de table en bois massif usé (merisier) - 38 1/8" x 60" avec une rallonge de 15"



Architect 40563B

Screw stool / Tabouret à vis

Colors shown / Couleurs montrées : Harley (51) / Toasty (87)

Norcross 50563-42

Table base / Base de table

90412

Distressed solid wood tabletop (birch) - 42" dia.

Dessus de table en bois massif usé (merisier) - 42" dia.



Dexter 40323-26B

Non swivel stool/ *Tabouret non pivotant*

Colors shown/ *Couleurs montrées* : Harley (51)/ Sand dust (86)



Dexter 30223B

Chair / Chaise

Colors shown / Couleurs montrées : Harley (51) / Biscuit (HO) / Sand dust (86)

Dexter 30223

Chair / Chaise

Tacoma 50516

Table base / Base de table

90460

Distressed solid wood tabletop with decorative bolts (birch) - 38 1/8" x 60" with two 15" leaves
 Dessus de table en bois massif usé avec vis décoratives (merisier) - 38 1/8" x 60" avec deux rallonges de 15"



Brixton 30536

Chair / Chaise

Norcross 50563

Table base / Base de table

90408

Distressed solid wood tabletop (birch) - 36" x 36"
Dessus de table en bois massif usé (merisier) - 36" x 36"

Colors shown / Couleurs montrées : Harley (51) / Shiitake (HT) / Stone dust (89)



Brixton 41536-26

Swivel stool / *Tabouret pivotant*

Colors shown / *Couleurs montrées* : Harley (51) / Shiitake (HT)



Russell 41526-26

Swivel stool/Tabouret pivotant

Colors shown/Couleurs montrées : Oxidado (52)/Oyster (DB)



Kent 41528-26

Swivel stool / *Tabouret pivotant*

Colors shown / *Couleurs montrées* : Black coral / *Noir corail* (25) / Elephant (DN)



Ethan 45308-30

Non swivel stool/ *Tabouret non pivotant*

Colors shown/ *Couleurs montrées* : Metallo (57)/ –/ Stone dust (89)

Parade 50565-42

Table base/ *Base de table*

90484

Distressed solid wood tabletop with decorative bolts (birch) – 40" x 84"
Dessus de table en bois massif usé avec vis décoratives (merisier) – 40" x 84"



Upright 40264-26

Non swivel stool / *Tabouret non pivotant*

Colors shown / *Couleurs montrées* : Oxidado (52) / — / Toasty (87)



Bradley 40038-30B

Non swivel stool/ *Tabouret non pivotant*

Colors shown/ *Couleurs montrées* : Falcon (74)/Toasty (87)

Aden 50537-42

Table base/ *Base de table*

50838-BO

Distressed solid wood tabletop (birch) -
23 7/8" x 23 7/8"
Dessus de table en bois massif usé (merisier) -
23 7/8" x 23 7/8"



Upright 30410

Bench/Banc

Pablo 35304

Chair/Chaise

Parade 50565

Table base/Base de table

Colors shown / Couleurs montrées : Harley (51)/Biscuit (HO)/Sand dust (86)

90484

Distressed solid wood tabletop with decorative bolts (birch) - 40" x 84"
Dessus de table en bois massif usé avec vis décoratives (merisier) - 40" x 84"



Edwin 35198B

Chair / Chaise

Colors shown / Couleurs montrées : Oxidado (52) / Toasty (87)

Edwin 40198-26B

Non swivel stool / Tabouret non pivotant



Bean 30568B

Chair / Chaise

Colors shown / Couleurs montrées : Oxidado (52) / Sand dust (86)

Norcross 50563

Table base / Base de table

90412

Distressed solid wood tabletop (birch) - 42" dia.
Dessus de table en bois massif usé (merisier) - 42" dia.



Kyle 35214B

Chair / Chaise

Kyle 41414-26B

Swivel stool / Tabouret pivotant

Kai 50609

Table base / Base de table

Colors shown / Couleurs montrées : Oxidado (52) / Toasty (87)

90412

Distressed solid wood tabletop (birch) - 42" dia.
Dessus de table en bois massif usé (merisier) - 42" dia.



Architect 42563

Screw stool / Tabouret à vis

Colors shown / Couleurs montrées : Black coral / Noir corail (25) / Elephant (DN)



Tori 30124B

Chair / Chaise

Tori 30144

Armchair / Chaise avec bras

Ricard 50664

Table base / Base de table

Colors shown / Couleurs montrées : Harley (51) / — / Toasty (87)

90410

Distressed solid wood tabletop (birch) -
36" x 60"
Dessus de table en bois massif usé (merisier) -
36" x 60"



Bean 41268-26B

Swivel stool / *Tabouret pivotant*

Colors shown / *Couleurs montrées* : Harley (51) / Toasty (87)

Boudoir

THE BOUDOIR MOOD

Ah, that special haven where everything is soft, elegant, romantic—and glamorous. You love the feminine lines of the furniture and the stylish sophistication of the ornamentation.

L'ESPRIT BOUDOIR

Là où tout est feutré, élégant, romantique et glamour. Vous aimez la féminité qui se lit dans les lignes du mobilier et des ornements au look sophistiqué.



DESIGNER'S SUGGESTIONS
LES SUGGESTIONS DU DESIGNER



Oxidado (52)/ Stratus (DD)
Tiramisu (47)



Magnetite (24)/ Oyster (DB)
Earl grey (48)



Titanium (56)/ Biscuit (HO)
Tiramisu (47)



Sunny 41575-26

Swivel stool / *Tabouret pivotant*

Colors shown / *Couleurs montrées* : Titanium (56) / Celestial (L9)



Atria 30346

Chair / Chaise

Colors shown / Couleurs montrées : Black coral / Noir corail (25) / Whisper (L5)

Link 50953

Table base / Base de table

91293

Italian porcelain on glass tabletop
(black marble finish) - 39 1/2" x 71 1/2"
Dessus de table en porcelaine italienne sur verre
(fini marbre noir) - 39 1/2" x 71 1/2"



Atria 40346-26

Non swivel stool / *Tabouret non pivotant*

Colors shown / *Couleurs montrées* : Sun gold (27) / Whisper (L5)



Giulia 30537

Chair / Chaise

Colors shown / Couleurs montrées : Black coral / Noir corail (25) / Silverpoint (KZ)

Tayra 50998

Table base / Base de table

91293

Italian porcelain on glass tabletop
(black marble finish) - 39 1/2" x 83 1/2"
Dessus de table en porcelaine italienne sur verre
(fini marbre noir) - 39 1/2" x 83 1/2"



Milanos 30350

Chair with metal armrests / *Chaise avec appuis-bras en métal*

Colors shown / *Couleurs montrées* : Black coral / *Noir corail* (25) / Cerulean (JK) / Black marble / *Marbre noir* / Pine cone (96)

Niles 30351

Chair / *Chaise*

Zenith 52584

Extendable table base / *Base de table extensible*

92249

Italian porcelain on glass tabletop - 39 1/2" x 83 1/2" with a 36" walnut wood veneer butterfly leaf
Dessus de table en porcelaine italienne sur verre - 39 1/2" x 83 1/2" avec une rallonge papillon de 36" en placage de noyer



Allegro 40043-26

Non swivel stool / *Tabouret non pivotant*

Colors shown / *Couleurs montrées* : Sun gold (27) / Blizzard (DH)



Milanos 40350-26

Non swivel stool / *Tabouret non pivotant*

Color shown / *Couleur montrée* : Magnetite (24) / —



Diaz 41297-26

Swivel stool with solid wood legs (birch) and metal footrest / *Tabouret pivotant avec pattes en bois massif (merisier) et appui-pied en métal*

Colors shown / *Couleurs montrées* : Black coral / *Noir corail* (25) / Silverpoint (KZ) / Pine cone (96)



Niles 41351-26

Swivel stool / *Tabouret pivotant*

Colors shown / *Couleurs montrées* : Magnetite (24) / Boardwalk (KX)



Milanos 30350

Chair / Chaise

Niles 30351

Chair / Chaise

Lidya 50984

Table base / Base de table

Colors shown / Couleurs montrées : Magnetite (24)/Boardwalk (KX)

90293

Italian porcelain on glass tabletop
(statuario marble finish) - 39 1/2" x 83 1/2"
Dessus de table en porcelaine italienne sur verre
(fini marbre statuario) - 39 1/2" x 83 1/2"



Darlene 30573

Chair / Chaise

Colors shown / Couleurs montrées : Titanium (56) / Valentine (KF)

Darcy 30574

Chair / Chaise

Nicholson 50967

Table base / Base de table

90293

Italian porcelain on glass tabletop
(statuario marble finish) - 39 1/2" x 83 1/2"
Dessus de table en porcelaine italienne sur verre
(fini marbre statuario) - 39 1/2" x 83 1/2"



Glenn 41597-26

Swivel stool / *Tabouret pivotant*

Colors shown / *Couleurs montrées* : Sun gold (27) / Emerald (JL)



Wembley 41578-30

Swivel stool / *Tabouret pivotant*

Colors shown / *Couleurs montrées* : Sun gold (27) / Pebble (CB)

Dalia 50507-42

Table base / *Base de table*

91292

Italian porcelain on glass tabletop (black marble finish) - 39" dia.

Dessus de table en porcelaine italienne sur verre (fini marbre noir) - 39" dia.



Darlene 40573-26

Non swivel stool/Tabouret non pivotant

Colors shown/Couleurs montrées : Titanium (56)/Valentine (KF)



Cassandra 30345

Chair / Chaise

Colors shown / Couleurs montrées : Pure (61) / Silverpoint (KZ)

Calypso 51522

Table base / Base de table

90287

Ultra white glass tabletop - 48" dia.
Dessus de table en verre ultra blanc - 48" dia.



Webber 30330

Chair / Chaise

Colors shown / Couleurs montrées : Titanium (56) / Oyster (DB) / Shiitake (HT) / Stone dust (89)

Belleville 50514

Table base / Base de table

90461

Distressed solid wood tabletop (birch) - 38 1/8" x 60" with two 15" leaves
Dessus de table en bois massif usé (merisier) - 38 1/8" x 60" avec deux rallonges de 15"



Webber 41330-26

Swivel stool / *Tabouret pivotant*

Colors shown / *Couleurs montrées* : Titanium (56) / Shiitake (HT)



Weston 30534

Swivel chair / Chaise pivotante

Link 50553

Table base / Base de table

90485

Distressed solid wood tabletop (birch) - 40" x 84"
Dessus de table en bois massif usé (merisier) - 40" x 84"

Colors shown / Couleurs montrées : Sun gold (27) / Pure (61) / — / Sand dust (86)



Ethan 45308-26

Non swivel stool / *Tabouret non pivotant*

Colors shown / *Couleurs montrées* : Oxidado (52) / Shiitake (HT)



Scarlett 41344-26

Swivel stool/ *Tabouret pivotant*

Colors shown/ *Couleurs montrées* : Titanium (56)/Cerulean (JK)



Weston 41534-26

Swivel stool / *Tabouret pivotant*

Color shown / *Couleur montrée* : Sun gold (27) / —

Countryside

COME HOME TO THE COUNTRYSIDE

Wood accents and warm, irresistibly tasteful colors. Chez vous, old-fashioned finishes and textures pair perfectly with floral prints and stripes.

UN GOÛT DE CAMPAGNE

Les touches de bois, les couleurs chaudes et gourmandes vous attirent comme un aimant. Chez vous, les finis vieillis et texturés s'acoignent avec les motifs floraux et les rayures.



DESIGNER'S SUGGESTIONS
LES SUGGESTIONS DU DESIGNER



Harley (51)/Morille (DW)
Cashew (46)



Cobrizo (75)/Complicity (KL)
Beachwood (42)



Oxidado (52)/Shiitake (HT)
Pine cone (96)



Marcus 41451-26

Swivel stool / *Tabouret pivotant*

Color shown / *Couleur montrée* : Oxidado (52) / —



Garden 41488-26

Swivel stool/ *Tabouret pivotant*

Color shown/ *Couleur montrée* : Cobrizo (75)/—



Oxford 41510-26

Swivel stool / *Tabouret pivotant*

Colors shown / *Couleurs montrées* : Cobrizo (75) / Stratus (DD)



Whisky 41512-26

Swivel stool/ *Tabouret pivotant*

Colors shown/ *Couleurs montrées* : Mineral (73)/Pebble (CB)/Tiramisu (47)

Products and Specifications
Produits et spécifications

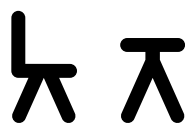

Chairs and Stools
Chaises et tabourets..... **151**



Benches
Bancs..... **208**

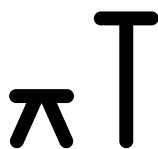

Accent Furniture
Meubles d'accent..... **213**

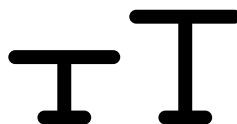

Table Bases
Bases de table..... **231**

Zenith Table Bases
Bases de table Zenith..... **309**

Tabletops
Dessus de table..... **313**

Chairs and Stools *Chaises et tabourets*

Aaron 40039

Urban

NON SWIVEL STOOL

Upholstered seat

TABOURET NON PIVOTANT

Siège rembourré

Colors shown/ *Couleurs montrées* :
Magnetite (24)/Pixel (BP)



in/po	W/L	D/P	H	S
26	15	15	26 3/4	26 3/4
30	15	15	30 3/4	30 3/4

Aaron 40039-B

Urban

NON SWIVEL STOOL

Solid wood (birch) seat

TABOURET NON PIVOTANT

Siège en bois massif (merisier)

Colors shown/ *Couleurs montrées* :
Magnetite (24)/Stone dust (89)



Wood colors available/ *Couleurs de bois disponibles*

Distressed solid wood/ *Bois massif usé*

78	79	80	81	82	84	86	87	89	93	45
----	----	----	----	----	----	----	----	----	----	----

Non-distressed solid wood/ *Bois massif non usé*

39	41	42	43	44	46	47	48	49	96	85
----	----	----	----	----	----	----	----	----	----	----

in/po	W/L	D/P	H	S
26B	15	15	25 1/2	25 1/2
30B	15	15	29 1/2	29 1/2

Allegro 40043

Boudoir

NON SWIVEL STOOL

Upholstered seat

TABOURET NON PIVOTANT

Siège rembourré

Colors shown/ *Couleurs montrées* :
Sun gold (27)/Blizzard (DH)



in/po	W/L	D/P	H	S
26	17 1/4	17 1/4	26 3/4	26 3/4
30	17 1/4	17 1/4	30 3/4	30 3/4

Allegro 40043-B

Boudoir

NON SWIVEL STOOL

Solid wood (birch) seat

TABOURET NON PIVOTANT

Siège en bois massif (merisier)

Colors shown/ *Couleurs montrées* :
Sun gold (27)/Pine cone (96)



Wood colors available/ *Couleurs de bois disponibles*

Distressed solid wood/ *Bois massif usé*

78	79	80	81	82	84	86	87	89	93	45
----	----	----	----	----	----	----	----	----	----	----

Non-distressed solid wood/ *Bois massif non usé*

39	41	42	43	44	46	47	48	49	96	85
----	----	----	----	----	----	----	----	----	----	----

in/po	W/L	D/P	H	S
26B	17	17	25 1/4	25 1/4
30B	17	17	29 1/4	29 1/4

Alto 35309

Boudoir

CHAIR

Upholstered seat and backrest

CHAISE

Siège et dossier rembourrés

Colors shown / *Couleurs montrées* :
Titanium (56) / Oyster (DB)



in/po	W/L	D/P	H	S
	17 1/2	23 1/2	38 1/2	18 3/4

Anders 42593

Urban

SWIVEL STOOL

(without memory return)
Upholstered seat

TABOURET PIVOTANT

*(sans mécanisme à mémoire)
Siège rembourré*

Colors shown / *Couleurs montrées* :
Titanium (56) / Limestone (EV)



in/po	W/L	D/P	H	S
26	16 1/2	16 1/2	26	26
30	17 3/4	17 3/4	30	30
34	18 3/4	18 3/4	34	34

Angelina 30227B

Farmhouse

CHAIR

Solid wood (birch) seat and
accent with metal backrest

CHAISE

*Siège et accent en bois massif
(merisier) avec dossier en métal*

Colors shown / *Couleurs montrées* :
Oxidado (52) / Sand dust (86)



Wood colors available / *Couleurs de bois disponibles*

Distressed solid wood / *Bois massif usé*

78	79	80	81	82	84	86	87	89	93	45
----	----	----	----	----	----	----	----	----	----	----

Non-distressed solid wood / *Bois massif non usé*

39	41	42	43	44	46	47	48	49	96	85
----	----	----	----	----	----	----	----	----	----	----

in/po	W/L	D/P	H	S
	21 5/8	23	35 3/4	18 3/8

Angelina 40227-B

Farmhouse

NON SWIVEL STOOL

Solid wood (birch) seat and
accent with metal backrest

TABOURET NON PIVOTANT

*Siège et accent en bois massif
(merisier) avec dossier en métal*

Colors shown / *Couleurs montrées* :
Oxidado (52) / Cashew (46)



Wood colors available / *Couleurs de bois disponibles*

Distressed solid wood / *Bois massif usé*

78	79	80	81	82	84	86	87	89	93	45
----	----	----	----	----	----	----	----	----	----	----

Non-distressed solid wood / *Bois massif non usé*

39	41	42	43	44	46	47	48	49	96	85
----	----	----	----	----	----	----	----	----	----	----

in/po	W/L	D/P	H	S
26B	21 5/8	22 3/4	40	26
30B	21 5/8	22 3/4	44	30

Annabelle 35219B

Farmhouse

CHAIR

Solid wood (birch) seat and accent with metal backrest

CHAISE

Siège et accent en bois massif (merisier) avec dossier en métal

Colors shown / Couleurs montrées :
Cobrizo (75) / Beachwood (42)



Wood colors available / Couleurs de bois disponibles

Distressed solid wood / Bois massif usé

78	79	80	81	82	84	86	87	89	93	45
----	----	----	----	----	----	----	----	----	----	----

Non-distressed solid wood / Bois massif non usé

39	41	42	43	44	46	47	48	49	96	85
----	----	----	----	----	----	----	----	----	----	----

in/po	W/L	D/P	H	S
	19 1/2	23 1/8	39	17 1/8

Annabelle 35219

Farmhouse

CHAIR

Upholstered seat and metal backrest with solid wood (birch) accent

CHAISE

Siège rembourré et dossier en métal avec accent en bois massif (merisier)

Colors shown / Couleurs montrées :
Cobrizo (75) / Pebble (CB) /
Beachwood (42)



Wood colors available / Couleurs de bois disponibles

Distressed solid wood / Bois massif usé

78	79	80	81	82	84	86	87	89	93	45
----	----	----	----	----	----	----	----	----	----	----

Non-distressed solid wood / Bois massif non usé

39	41	42	43	44	46	47	48	49	96	85
----	----	----	----	----	----	----	----	----	----	----

in/po	W/L	D/P	H	S
	19 1/2	23	39	19

Annabelle 41419-B

Farmhouse

SWIVEL STOOL

(with memory return)
Solid wood (birch) seat and accent with metal backrest

TABOURET PIVOTANT

*(avec mécanisme à mémoire)
Siège et accent en bois massif (merisier) avec dossier en métal*

Colors shown / Couleurs montrées :
Cobrizo (75) / Milk (80)



Wood colors available / Couleurs de bois disponibles

Distressed solid wood / Bois massif usé

78	79	80	81	82	84	86	87	89	93	45
----	----	----	----	----	----	----	----	----	----	----

Non-distressed solid wood / Bois massif non usé

39	41	42	43	44	46	47	48	49	96	85
----	----	----	----	----	----	----	----	----	----	----

in/po	W/L	D/P	H	S
26B	18 1/2	21	45 1/2	25 1/4
30B	18 1/2	21	49 1/2	29 1/4
34B	18 1/2	21 1/2	53 1/2	33 1/4

Annabelle 41419

Farmhouse

SWIVEL STOOL

(with memory return)
Upholstered seat and metal backrest with solid wood (birch) accent

TABOURET PIVOTANT

*(avec mécanisme à mémoire)
Siège rembourré et dossier en métal avec accent en bois massif (merisier)*

Colors shown / Couleurs montrées :
Cobrizo (75) / Pebble (CB) /
Milk (80)



Wood colors available / Couleurs de bois disponibles

Distressed solid wood / Bois massif usé

78	79	80	81	82	84	86	87	89	93	45
----	----	----	----	----	----	----	----	----	----	----

Non-distressed solid wood / Bois massif non usé

39	41	42	43	44	46	47	48	49	96	85
----	----	----	----	----	----	----	----	----	----	----

in/po	W/L	D/P	H	S
26	18 1/2	21	45 1/2	26 1/2
30	18 1/2	21	49 1/2	30 1/2
34	18 1/2	21 1/2	53 1/2	34 1/2

Anton 42231

Urban

SWIVEL STOOL
(without memory return)
Solid wood base (birch) with upholstered seat

TABOURET PIVOTANT
(sans mécanisme à mémoire)
Base en bois massif (merisier)
avec siège rembourré

Colors shown / Couleurs montrées :
Pine cone (96) / Marshmallow (DX)



Wood colors available / Couleurs de bois disponibles

47 48 96

in/po	W/L	D/P	H	S
26	18	18	26	26
30	18	18	30	30

Architect 30263

Industrial

CHAIR
Upholstered seat and solid wood (birch) backrest

CHAISE
Siège rembourré et dossier en bois massif (merisier)

Colors shown / Couleurs montrées :
Harley (51) / Elephant (DN) / Stone dust (89)



Wood colors available / Couleurs de bois disponibles

Distressed solid wood / Bois massif usé

78 79 80 81 82 84 86 87 89 93 45

Non-distressed solid wood / Bois massif non usé

39 41 42 43 44 46 47 48 49 96 85

in/po	W/L	D/P	H	S
	18	21 3/4	32 1/4	19

Architect 30263B

Industrial

CHAIR
Solid wood (birch) seat and backrest

CHAISE
Siège et dossier en bois massif (merisier)

Colors shown / Couleurs montrées :
Harley (51) / Stone dust (89)



Wood colors available / Couleurs de bois disponibles

Distressed solid wood / Bois massif usé

78 79 80 81 82 84 86 87 89 93 45

Non-distressed solid wood / Bois massif non usé

39 41 42 43 44 46 47 48 49 96 85

in/po	W/L	D/P	H	S
	18	21 3/4	32 1/4	17 1/2

Architect 30563

Industrial

CHAIR
Upholstered seat and metal backrest

CHAISE
Siège rembourré et dossier en métal

Colors shown / Couleurs montrées :
Harley (51) / Elephant (DN)



in/po	W/L	D/P	H	S
	18	21	32 3/4	19

Architect 30563B

Industrial

CHAIR

Solid wood (birch) seat and metal backrest

CHAISE

Siège en bois massif (merisier) et dossier en métal

Colors shown / Couleurs montrées : Harley (51) / Stone dust (89)



Wood colors available / Couleurs de bois disponibles

Distressed solid wood / Bois massif usé

78	79	80	81	82	84	86	87	89	93	45
----	----	----	----	----	----	----	----	----	----	----

Non-distressed solid wood / Bois massif non usé

39	41	42	43	44	46	47	48	49	96	85
----	----	----	----	----	----	----	----	----	----	----

in/po	W/L	D/P	H	S
	18	21	32 3/4	17 1/2

Architect 40263

Industrial

SCREW STOOL

Upholstered seat and solid wood (birch) backrest

TABOURET À VIS

Siège rembourré et dossier en bois massif (merisier)

Colors shown / Couleurs montrées : Harley (51) / Elephant (DN) / Toasty (87)



Wood colors available / Couleurs de bois disponibles

Distressed solid wood / Bois massif usé

78	79	80	81	82	84	86	87	89	93	45
----	----	----	----	----	----	----	----	----	----	----

Non-distressed solid wood / Bois massif non usé

39	41	42	43	44	46	47	48	49	96	85
----	----	----	----	----	----	----	----	----	----	----

in/po	W/L	D/P	H	S
	16 1/4	19 7/8	37 - 42 3/8	25 7/8 - 31 1/4

Architect 40263B

Industrial

SCREW STOOL

Solid wood (birch) seat and backrest

TABOURET À VIS

Siège et dossier en bois massif (merisier)

Colors shown / Couleurs montrées : Harley (51) / Toasty (87)



Wood colors available / Couleurs de bois disponibles

Distressed solid wood / Bois massif usé

78	79	80	81	82	84	86	87	89	93	45
----	----	----	----	----	----	----	----	----	----	----

Non-distressed solid wood / Bois massif non usé

39	41	42	43	44	46	47	48	49	96	85
----	----	----	----	----	----	----	----	----	----	----

in/po	W/L	D/P	H	S
	16 1/4	19 7/8	37 - 42 3/8	25 - 30 3/8

Architect 40563

Industrial

SCREW STOOL

Upholstered seat and metal backrest

TABOURET À VIS

Siège rembourré et dossier en métal

Colors shown / Couleurs montrées : Harley (51) / Elephant (DN)



in/po	W/L	D/P	H	S
	16 1/4	19 7/8	37 - 42 3/8	25 7/8 - 31 1/4

Architect 40563B

Industrial

SCREW STOOL

Solid wood (birch) seat and metal backrest

TABOURET À VIS

Siège en bois massif (merisier) et dossier en métal

Colors shown / Couleurs montrées : Harley (51) / Toasty (87)



Wood colors available / Couleurs de bois disponibles

Distressed solid wood / Bois massif usé

78	79	80	81	82	84	86	87	89	93	45
----	----	----	----	----	----	----	----	----	----	----

Non-distressed solid wood / Bois massif non usé

39	41	42	43	44	46	47	48	49	96	85
----	----	----	----	----	----	----	----	----	----	----

in/po	W/L	D/P	H	S
	16 1/4	19 7/8	37 - 42 3/8	25 - 30 3/8

Architect 42563

Industrial

SCREW STOOL

Upholstered seat

TABOURET À VIS

Siège rembourré

Colors shown / Couleurs montrées : Harley (51) / Elephant (DN)



in/po	W/L	D/P	H	S
	16 1/4	16 1/4	25 7/8 - 31 1/4	25 7/8 - 31 1/4

Architect 42563B

Industrial

SCREW STOOL

Solid wood (birch) seat

TABOURET À VIS

Siège en bois massif (merisier)

Colors shown / Couleurs montrées : Harley (51) / Toasty (87)



Wood colors available / Couleurs de bois disponibles

Distressed solid wood / Bois massif usé

78	79	80	81	82	84	86	87	89	93	45
----	----	----	----	----	----	----	----	----	----	----

Non-distressed solid wood / Bois massif non usé

39	41	42	43	44	46	47	48	49	96	85
----	----	----	----	----	----	----	----	----	----	----

in/po	W/L	D/P	H	S
	16 1/4	16 1/4	25 - 30 3/8	25 - 30 3/8

Atria 30346

Boudoir

NEW

CHAIR

Upholstered seat and backrest

NOUVEAU

CHAISE

Siège et dossier rembourrés

Colors shown / Couleurs montrées : Sun gold (27) / Whisper (L5)



in/po	W/L	D/P	H	S	A
	24	23 3/4	31 3/4	18 3/4	25 1/4

Atria 40346

Boudoir

NEW
NON SWIVEL STOOL
Upholstered seat and backrest

NOUVEAU
TABOURET NON PIVOTANT

Siège et dossier rembourrés

Colors shown/ Couleurs montrées :
Sun gold (27)/Whisper (L5)



in/po	W/L	D/P	H	S	A
26	24	23 3/4	39 3/4	26 3/4	33 1/4
30	24 1/4	24 1/4	43 3/4	30 3/4	37 1/4

Barry 41445

Urban

SWIVEL STOOL
(without memory return)
Upholstered seat and backrest

TABOURET PIVOTANT
(sans mécanisme à mémoire)
Siège et dossier rembourrés

Colors shown/ Couleurs montrées :
Dayglam (53)/Ink (DA)



in/po	W/L	D/P	H	S
26	17 3/4	21	36 1/2	26
30	17 3/4	21	40 1/2	30
34	17 3/4	21	44 1/2	34

Bean 30268

Industrial

CHAIR
Upholstered seat and solid wood (birch) backrest

CHAISE
Siège rembourré et dossier en bois massif (merisier)

Colors shown/ Couleurs montrées :
Oxidado (52)/Morille (DW)/
Sand dust (86)



Wood colors available/ Couleurs de bois disponibles
Distressed solid wood/ Bois massif usé

78	79	80	81	82	84	86	87	89	93	45
----	----	----	----	----	----	----	----	----	----	----

Non-distressed solid wood/ Bois massif non usé

39	41	42	43	44	46	47	48	49	96	85
----	----	----	----	----	----	----	----	----	----	----

in/po	W/L	D/P	H	S
	17 1/2	20 3/4	33 1/4	19

Bean 30268B

Industrial

CHAIR
Solid wood (birch) seat and backrest

CHAISE
Siège et dossier en bois massif (merisier)

Colors shown/ Couleurs montrées :
Oxidado (52)/ Sand dust (86)



Wood colors available/ Couleurs de bois disponibles
Distressed solid wood/ Bois massif usé

78	79	80	81	82	84	86	87	89	93	45
----	----	----	----	----	----	----	----	----	----	----

Non-distressed solid wood/ Bois massif non usé

39	41	42	43	44	46	47	48	49	96	85
----	----	----	----	----	----	----	----	----	----	----

in/po	W/L	D/P	H	S
	16 3/4	20 1/2	33 1/4	17 3/4

Bean 30568

Industrial

CHAIR

Upholstered seat and metal backrest

CHAISE

Siège rembourré et dossier en métal

Colors shown / Couleurs montrées : Harley (51) / Limestone (EV)



in/po	W/L	D/P	H	S
	17 1/2	21 3/4	34	19

Bean 30568B

Industrial

CHAIR

Solid wood (birch) seat and metal backrest

CHAISE

Siège en bois massif (merisier) et dossier en métal

Colors shown / Couleurs montrées : Oxidado (52) / Sand dust (86)



Wood colors available / Couleurs de bois disponibles

Distressed solid wood / Bois massif usé

78	79	80	81	82	84	86	87	89	93	45
----	----	----	----	----	----	----	----	----	----	----

Non-distressed solid wood / Bois massif non usé

39	41	42	43	44	46	47	48	49	96	85
----	----	----	----	----	----	----	----	----	----	----

in/po	W/L	D/P	H	S
	16 3/4	21 1/2	34	17 3/4

Bean 41268

Industrial

SWIVEL STOOL

(without memory return)
Upholstered seat and solid wood (birch) backrest

TABOURET PIVOTANT

(sans mécanisme à mémoire)
Siège rembourré et dossier en bois massif (merisier)

Colors shown / Couleurs montrées : Harley (51) / Biscuit (HO) / Toasty (87)



Wood colors available / Couleurs de bois disponibles

Distressed solid wood / Bois massif usé

78	79	80	81	82	84	86	87	89	93	45
----	----	----	----	----	----	----	----	----	----	----

Non-distressed solid wood / Bois massif non usé

39	41	42	43	44	46	47	48	49	96	85
----	----	----	----	----	----	----	----	----	----	----

in/po	W/L	D/P	H	S
26	17 1/2	20 1/2	38 1/2	26 3/4
30	17 1/2	20 1/2	42 1/2	30 3/4

Bean 41268-B

Industrial

SWIVEL STOOL

(without memory return)
Solid wood (birch) seat and backrest

TABOURET PIVOTANT

(sans mécanisme à mémoire)
Siège et dossier en bois massif (merisier)

Colors shown / Couleurs montrées : Harley (51) / Toasty (87)



Wood colors available / Couleurs de bois disponibles

Distressed solid wood / Bois massif usé

78	79	80	81	82	84	86	87	89	93	45
----	----	----	----	----	----	----	----	----	----	----

Non-distressed solid wood / Bois massif non usé

39	41	42	43	44	46	47	48	49	96	85
----	----	----	----	----	----	----	----	----	----	----

in/po	W/L	D/P	H	S
26B	16 3/4	20 1/2	38 1/2	25 1/2
30B	16 3/4	20 1/2	42 1/2	29 1/2

Bean 41568

Industrial

SWIVEL STOOL
(without memory return)
Upholstered seat and
metal backrest

TABOURET PIVOTANT
(sans mécanisme à mémoire)
Siège rembourré et dossier
en métal

Colors shown / Couleurs montrées :
Harley (51) / Biscuit (HO)



in/po	W/L	D/P	H	S
26	17 1/2	21	39 3/8	26 3/4
30	17 1/2	21	43 3/8	30 3/4

Bean 41568-B

Industrial

SWIVEL STOOL
(without memory return)
Solid wood (birch) seat
and metal backrest

TABOURET PIVOTANT
(sans mécanisme à mémoire)
Siège en bois massif (merisier)
et dossier en métal

Colors shown / Couleurs montrées :
Harley (51) / Toasty (87)



Wood colors available / Couleurs de bois disponibles
Distressed solid wood / Bois massif usé

78	79	80	81	82	84	86	87	89	93	45
----	----	----	----	----	----	----	----	----	----	----

Non-distressed solid wood / Bois massif non usé

39	41	42	43	44	46	47	48	49	96	85
----	----	----	----	----	----	----	----	----	----	----

in/po	W/L	D/P	H	S
26B	16 3/4	21	39 3/8	25 1/2
30B	16 3/4	21	43 3/8	29 1/2

Bellamy 30354

Nordic

CHAIR
Upholstered seat and
backrest

CHAISE
Siège et dossier rembourrés

Colors shown / Couleurs montrées :
Black coral / Noir corail (25)
Oceanic (JM)



in/po	W/L	D/P	H	S
20 3/4	22 1/4	32 1/2	18 3/4	

Bellamy 40354

Nordic

NON SWIVEL STOOL
Upholstered seat and
backrest

**TABOURET
NON PIVOTANT**
Siège et dossier rembourrés

Colors shown / Couleurs montrées :
Black coral / Noir corail (25)
Oceanic (JM)



in/po	W/L	D/P	H	S
26	21 7/8	22 1/4	37 3/4	26 3/4
30	21 7/8	22 1/4	41 3/4	30 3/4

Benson 30336

Nordic

CHAIR

Upholstered seat and backrest

CHAISE

Siège et dossier rembourrés

Colors shown / Couleurs montrées :
Black coral / Noir corail (25) /
Merino (JT)

Covering unavailable / Recouvrement
non disponible : Breezy (JS)



in/po	W/L	D/P	H	S	A
	23 5/8	23	33	19 3/4	30 1/2

Benson 41336

Nordic

SWIVEL STOOL

(without memory return)

Upholstered seat and backrest

TABOURET PIVOTANT

(sans mécanisme à mémoire)

Siège et dossier rembourrés

Colors shown / Couleurs montrées :
Black coral / Noir corail (25) /
Parchment (GT)

Covering unavailable / Recouvrement
non disponible : Breezy (JS)



in/po	W/L	D/P	H	S	
26	23 5/8	23	39 3/4	26 1/4	37 1/4
30	23 5/8	23	43 3/4	30 1/4	41 1/4

Bradley 40038

Urban

NON SWIVEL STOOL

Upholstered seat

TABOURET NON PIVOTANT

Siège rembourré

Colors shown / Couleurs montrées :
Dayglam (53) / Oceanic (JM)



in/po	W/L	D/P	H	S
26	17 1/2	13 1/2	25 7/8	25 7/8
30	17 1/2	13 1/2	29 7/8	29 7/8

Bradley 40038-B

Industrial

NON SWIVEL STOOL

Solid wood (birch) seat

TABOURET NON PIVOTANT

Siège en bois massif (merisier)

Colors shown / Couleurs montrées :
Falcon (74) / Toasty (87)



Wood colors available / Couleurs de bois disponibles

Distressed solid wood / Bois massif usé

78	79	80	81	82	84	86	87	89	93	45
----	----	----	----	----	----	----	----	----	----	----

Non-distressed solid wood / Bois massif non usé

39	41	42	43	44	46	47	48	49	96	85
----	----	----	----	----	----	----	----	----	----	----

in/po	W/L	D/P	H	S
26B	17 3/8	13 1/4	24 3/4	24 3/4
30B	17 3/8	13 3/8	28 3/4	28 3/4

Bray 30333

Urban

CHAIR

Upholstered seat and backrest with leather accent

CHAISE

Siège et dossier rembourrés avec accent de cuir

Colors shown / Couleurs montrées :
Black coral / Noir corail (25) /
Illusion (KO) / Black leather /
Cuir noir (OB)



Leather colors available / Couleurs de cuir disponibles

OT OB

in/po	W/L	D/P	H	S
	18 1/2	22 1/4	35 1/4	18 1/4

Bray 41333

Urban

SWIVEL STOOL

(without memory return)
Upholstered seat and backrest with leather accent

TABOURET PIVOTANT

*(sans mécanisme à mémoire)
Siège et dossier rembourrés avec accent de cuir*

Colors shown / Couleurs montrées :
Black coral / Noir corail (25) /
Silverpoint (KZ) / Black leather /
Cuir noir (OB)



Leather colors available / Couleurs de cuir disponibles

OT OB

in/po	W/L	D/P	H	S
26	18 1/2	22	42 1/4	25 1/4
30	18 1/2	22	46 1/4	29 1/4

Bridget 30575

Farmhouse

CHAIR

Upholstered seat and backrest

CHAISE

Siège et dossier rembourrés

Colors shown / Couleurs montrées :
Oxidado (52) / Sheep (JU)



in/po	W/L	D/P	H	S
	21	25 1/4	37 1/2	19

Bridget 40575

Farmhouse

NON SWIVEL STOOL

Upholstered seat and backrest

TABOURET NON PIVOTANT

Siège et dossier rembourrés

Colors shown / Couleurs montrées :
Oxidado (52) / Sheep (JU)



in/po	W/L	D/P	H	S
26	21	24 1/4	46 1/4	27 3/4
30	21	24 1/4	50 1/4	31 3/4

Brittany 41405

Countryside

SWIVEL STOOL

(with memory return)
Upholstered seat and metal
backrest with non-distressed
solid wood (birch) accent

TABOURET PIVOTANT

(avec mécanisme à mémoire)
Siège rembourré et dossier
en métal avec accent en bois
massif non usé (merisier)

Colors shown / Couleurs montrées :
Titanium (56) / Oyster (DB) /
Verdastro (39)



Wood colors available / Couleurs de bois disponibles

Distressed solid wood / Bois massif usé

78	79	80	81	82	84	86	87	89	93	45
----	----	----	----	----	----	----	----	----	----	----

Non-distressed solid wood / Bois massif non usé

39	41	42	43	44	46	47	48	49	96	85
----	----	----	----	----	----	----	----	----	----	----

in/po	W/L	D/P	H	S
26	17 3/4	19 1/2	40 3/4	26 1/2
30	17 3/4	19 1/2	44 3/4	30 1/2
34	18 3/4	20 1/4	48 1/2	34 1/8

Brixton 30536

Industrial

CHAIR

Upholstered seat and backrest

CHAISE

Siège et dossier rembourrés

Colors shown / Couleurs montrées :
Harley (51) / Shiitake (HT)



in/po	W/L	D/P	H	S
	17 7/8	22 1/4	33	19

Brixton 41536

Industrial

SWIVEL STOOL

(without memory return)
Upholstered seat and backrest

TABOURET PIVOTANT

(sans mécanisme à mémoire)
Siège et dossier rembourrés

Colors shown / Couleurs montrées :
Harley (51) / Shiitake (HT)



in/po	W/L	D/P	H	S
26	18 3/4	22 1/2	41 1/4	27
30	18 3/4	22 1/2	45 1/4	31
34	18 3/4	22 1/2	49 1/4	35

Brock 41435

Urban

SWIVEL STOOL

(without memory return)
Upholstered seat and backrest

TABOURET PIVOTANT

(sans mécanisme à mémoire)
Siège et dossier rembourrés

Colors shown / Couleurs montrées :
Black coral / Noir corail (25) /
Blizzard (DH)



in/po	W/L	D/P	H	S
26	17 1/4	20	37 5/8	26 7/8
30	18	20	41 5/8	30 7/8
34	19 1/4	20	45 5/8	34 7/8

Bryce 41444

Urban

SWIVEL STOOL
(without memory return)
Upholstered seat

TABOURET PIVOTANT
(sans mécanisme à mémoire)
Siège rembourré

Colors shown/ Couleurs montrées :
Oxidado (52)/Sheep (JU)



in/po	W/L	D/P	H	S
26	17 3/4	18 3/8	26	26
30	17 3/4	18 3/8	30	30
34	17 3/4	18 7/8	34	34

Button 42460

Nordic

SWIVEL STOOL
(without memory return)
Upholstered seat

TABOURET PIVOTANT
(sans mécanisme à mémoire)
Siège rembourré

Colors shown/ Couleurs montrées :
Titanium (56)/Pebble (CB)



in/po	W/L	D/P	H	S
26	16 3/8	16 3/8	26 5/8	26 5/8
30	16 3/8	16 3/8	30 5/8	30 5/8
34	16 1/2	16 1/2	33 5/8	33 5/8

Button 42460-B

Industrial

SWIVEL STOOL
(without memory return)
Solid wood (birch) seat

TABOURET PIVOTANT
(sans mécanisme à mémoire)
Siège en bois massif (merisier)

Colors shown/ Couleurs montrées :
Oxidado (52)/Toasty (87)



Wood colors available/ Couleurs de bois disponibles
Distressed solid wood/ Bois massif usé

78	79	80	81	82	84	86	87	89	93	45
----	----	----	----	----	----	----	----	----	----	----

Non-distressed solid wood/ Bois massif non usé

39	41	42	43	44	46	47	48	49	96	85
----	----	----	----	----	----	----	----	----	----	----

in/po	W/L	D/P	H	S
26B	16 3/8	16 3/8	26 1/4	26 1/4
30B	16 3/8	16 3/8	30 1/4	30 1/4
34B	16 1/2	16 1/2	33 1/4	33 1/4

Cardin 41430

Boudoir

SWIVEL STOOL
(without memory return)
Upholstered seat and backrest
with metal armrests

TABOURET PIVOTANT
(sans mécanisme à mémoire)
Siège et dossier rembourrés
avec appuis-bras en métal

Colors shown/ Couleurs montrées :
Oxidado (52)/Marshmallow (DX)



in/po	W/L	D/P	H	S	A
26	22 1/4	25 1/2	41 3/8	26 1/2	34 3/8
30	22 1/4	25 1/2	45 3/8	30 1/2	38 3/8
34	22 1/4	25 1/2	49 3/8	34 1/2	42 3/8

Carson 41519

Nordic

SWIVEL STOOL

(without memory return)
Upholstered seat and wood
vener backrest (birch)

TABOURET PIVOTANT

(sans mécanisme à mémoire)
Siège rembourré et dossier en
placage de bois (merisier)

Colors shown / Couleurs montrées :
Black coral / Noir corail (25) /
Licorice (EP) / Pine cone (96)



Wood veneer colors available / Couleurs de placage de bois disponibles

39	41	42	43	44	46	47	48	49	96	85
----	----	----	----	----	----	----	----	----	----	----

in/po	W/L	D/P	H	S
26	21	21	37	26
30	21	21	41	30
34	21	21	45	34

Cassandra 30345

Boudoir

NEW

CHAIR

Upholstered seat and backrest

NOUVEAU CHAISE

Siège et dossier rembourrés

Colors shown / Couleurs montrées :
Titanium (56) / Parchment (GT)



in/po	W/L	D/P	H	S
	19	23	33 3/4	18 1/4

Cassandra 40345

Boudoir

NEW

NON SWIVEL STOOL

Upholstered seat and backrest

NOUVEAU

TABOURET NON PIVOTANT

Siège et dossier rembourrés

Colors shown / Couleurs montrées :
Dayglam (53) / Tuxedo (JQ)



in/po	W/L	D/P	H	S
26	20 1/4	24 1/4	41 3/4	26 1/4
30	20 1/4	24 1/4	45 3/4	30 1/4

Collin 41234

Farmhouse

SWIVEL STOOL

(without memory return)
Solid wood base (birch) with
upholstered seat and backrest

TABOURET PIVOTANT

(sans mécanisme à mémoire)
Base en bois massif (merisier)
avec siège et dossier rembourrés

Colors shown / Couleurs montrées :
Tiramisu (47) / Biscuit (HO)



Wood colors available / Couleurs de bois disponibles

47	48	96
----	----	----

in/po	W/L	D/P	H	S
26	22	23 7/8	42 3/8	27
30	22	23 7/8	46 3/8	31

Connor 42493

Urban

SWIVEL STOOL
(without memory return)
Upholstered seat

TABOURET PIVOTANT
(sans mécanisme à mémoire)
Siège rembourré

Colors shown / Couleurs montrées :
Titanium (56) / Shiitake (HT)



in/po	W/L	D/P	H	S
26	16 1/2	16 1/2	26 3/4	26 3/4
30	17 3/4	17 3/4	30 3/4	30 3/4
34	18 3/4	18 3/4	34 3/4	34 3/4

Connor 42493-B

Industrial

SWIVEL STOOL
(without memory return)
Solid wood (birch) seat

TABOURET PIVOTANT
(sans mécanisme à mémoire)
Siège en bois massif (merisier)

Colors shown / Couleurs montrées :
Harley (51) / Shady (84)



Wood colors available / Couleurs de bois disponibles
Distressed solid wood / Bois massif usé

78	79	80	81	82	84	86	87	89	93	45
----	----	----	----	----	----	----	----	----	----	----

Non-distressed solid wood / Bois massif non usé

39	41	42	43	44	46	47	48	49	96	85
----	----	----	----	----	----	----	----	----	----	----

in/po	W/L	D/P	H	S
26B	16 1/2	16 1/2	25 1/2	25 1/2
30B	17 3/4	17 3/4	29 1/2	29 1/2
34B	18 3/4	18 3/4	33 1/2	33 1/2

Costa 41563

Urban

NEW
SWIVEL STOOL
(without memory return)
Upholstered seat and metal
backrest

NOUVEAU
TABOURET PIVOTANT
(sans mécanisme à mémoire)
Siège rembourré et dossier
en métal

Colors shown / Couleurs montrées :
Black coral / Noir corail (25) /
Doodle (L8)



in/po	W/L	D/P	H	S
26	18 1/8	19	33 7/8	26 1/4
30	18 1/8	19	37 7/8	30 1/4

Costa 42463

Urban

NEW
SWIVEL STOOL
(without memory return)
Upholstered seat

NOUVEAU
TABOURET PIVOTANT
(sans mécanisme à mémoire)
Siège rembourré

Colors shown / Couleurs montrées :
Black coral / Noir corail (25) /
Doodle (L8)



in/po	W/L	D/P	H	S
26	17 1/2	17 1/2	26 1/4	26 1/4
30	17 1/2	17 1/2	30 1/4	30 1/4

Costa 42463-B

Urban

NEW

SWIVEL STOOL

(without memory return)
Solid wood (birch) seat

NOUVEAU

TABOURET PIVOTANT

(sans mécanisme à mémoire)
Siège en bois massif (merisier)

Colors shown / Couleurs montrées :
Black coral / Noir corail (25)
Cashew (46)



Wood colors available / Couleurs de bois disponibles

Distressed solid wood / Bois massif usé

78	79	80	81	82	84	86	87	89	93	45
----	----	----	----	----	----	----	----	----	----	----

Non-distressed solid wood / Bois massif non usé

39	41	42	43	44	46	47	48	49	96	85
----	----	----	----	----	----	----	----	----	----	----

in/po	W/L	D/P	H	S
26B	17 1/2	17 1/2	25	25
30B	17 1/2	17 1/2	29	29

Crescent 30123

Countryside

CHAIR

Upholstered seat and
metal backrest

CHAISE

Siège rembourré et dossier
en métal

Colors shown / Couleurs montrées :
Falcon (74) / Sheep (JU)



in/po	W/L	D/P	H	S
	18	20 1/2	35 1/4	18 3/4

Crescent 30123B

Industrial

CHAIR

Solid wood (birch) seat and
metal backrest

CHAISE

Siège en bois massif (merisier)
et dossier en métal

Colors shown / Couleurs montrées :
Harley (51) / Shady (84)



Wood colors available / Couleurs de bois disponibles

Distressed solid wood / Bois massif usé

78	79	80	81	82	84	86	87	89	93	45
----	----	----	----	----	----	----	----	----	----	----

Non-distressed solid wood / Bois massif non usé

39	41	42	43	44	46	47	48	49	96	85
----	----	----	----	----	----	----	----	----	----	----

in/po	W/L	D/P	H	S
	18	20 1/2	35 1/4	17 1/2

Crescent 40123

Countryside

NON SWIVEL STOOL

Upholstered seat and
metal backrest

TABOURET

NON PIVOTANT

Siège rembourré et dossier
en métal

Colors shown / Couleurs montrées :
Falcon (74) / Sheep (JU)



in/po	W/L	D/P	H	S
26	18	21	41 1/4	27
30	18	21	45 1/4	31

Crescent 40123-B

Industrial

NON SWIVEL STOOL

Solid wood (birch) seat and metal backrest

TABOURET NON PIVOTANT

Siège en bois massif (merisier) et dossier en métal

Colors shown / Couleurs montrées : Harley (51) / Shady (84)



Wood colors available / Couleurs de bois disponibles

Distressed solid wood / Bois massif usé

78	79	80	81	82	84	86	87	89	93	45
----	----	----	----	----	----	----	----	----	----	----

Non-distressed solid wood / Bois massif non usé

39	41	42	43	44	46	47	48	49	96	85
----	----	----	----	----	----	----	----	----	----	----

in/po	W/L	D/P	H	S
26B	18	21	41 1/4	25 3/4
30B	18	21	45 1/4	29 3/4

Curve 30321

Urban

CHAIR

Upholstered seat and backrest

CHAISE

Siège et dossier rembourrés

Colors shown / Couleurs montrées : Magnetite (24) / Oyster (DB)



in/po	W/L	D/P	H	S
	18 1/4	21 3/8	39	18

Darcy 30574

Boudoir

CHAIR

Upholstered seat and backrest

CHAISE

Siège et dossier rembourrés

Colors shown / Couleurs montrées : Titanium (56) / Valentine (KF)



in/po	W/L	D/P	H	S
	18 1/4	23 1/2	33 3/4	19

Darcy 40574

Boudoir

NON SWIVEL STOOL

Upholstered seat and backrest

TABOURET NON PIVOTANT

Siège et dossier rembourrés

Colors shown / Couleurs montrées : Titanium (56) / Valentine (KF)



in/po	W/L	D/P	H	S
26	18 1/4	23	42 1/2	27
30	18 1/4	23	46 1/2	31

Darlene 30573

Boudoir

CHAIR

Upholstered seat and backrest

CHAISE

Siège et dossier rembourrés

Colors shown / Couleurs montrées :
Titanium (56) / Valentine (KF)



in/po	W/L	D/P	H	S
	18 1/4	23 1/2	33 3/4	19

Darlene 40573

Boudoir

NON SWIVEL STOOL

Upholstered seat and backrest

TABOURET

NON PIVOTANT

Siège et dossier rembourrés

Colors shown / Couleurs montrées :
Titanium (56) / Valentine (KF)



in/po	W/L	D/P	H	S
26	18 1/4	23	42 1/2	27
30	18 1/4	23	46 1/2	31

Dexter 30223

Industrial

CHAIR

Upholstered seat and solid wood (birch) backrest

CHAISE

Siège rembourré et dossier en bois massif (merisier)

Colors shown / Couleurs montrées :
Harley (51) / Biscuit (HO) /
Sand dust (86)



Wood colors available / Couleurs de bois disponibles

Distressed solid wood / Bois massif usé

78	79	80	81	82	84	86	87	89	93	45
----	----	----	----	----	----	----	----	----	----	----

Non-distressed solid wood / Bois massif non usé

39	41	42	43	44	46	47	48	49	96	85
----	----	----	----	----	----	----	----	----	----	----

in/po	W/L	D/P	H	S
	18 1/2	21 1/4	35 7/8	18 3/4

Dexter 30223B

Industrial

CHAIR

Solid wood (birch) seat and backrest

CHAISE

Siège et dossier en bois massif (merisier)

Colors shown / Couleurs montrées :
Harley (51) / Sand dust (86)



Wood colors available / Couleurs de bois disponibles

Distressed solid wood / Bois massif usé

78	79	80	81	82	84	86	87	89	93	45
----	----	----	----	----	----	----	----	----	----	----

Non-distressed solid wood / Bois massif non usé

39	41	42	43	44	46	47	48	49	96	85
----	----	----	----	----	----	----	----	----	----	----

in/po	W/L	D/P	H	S
	18 1/2	21 1/4	35 7/8	17 3/4

Dexter 40323

Industrial

NON SWIVEL STOOL

Upholstered seat and solid wood (birch) backrest

TABOURET NON PIVOTANT

Siège rembourré et dossier en bois massif (merisier)

Colors shown / Couleurs montrées : Harley (51) / Biscuit (HO) / Sand dust (86)



Wood colors available / Couleurs de bois disponibles

Distressed solid wood / Bois massif usé

78	79	80	81	82	84	86	87	89	93	45
----	----	----	----	----	----	----	----	----	----	----

Non-distressed solid wood / Bois massif non usé

39	41	42	43	44	46	47	48	49	96	85
----	----	----	----	----	----	----	----	----	----	----

in/po	W/L	D/P	H	S
26	18 1/2	20 3/4	41 1/4	26 1/4
30	18 1/2	20 3/4	45 1/4	30 1/4

Dexter 40323-B

Industrial

NON SWIVEL STOOL

Solid wood (birch) seat and backrest

TABOURET NON PIVOTANT

Siège et dossier en bois massif (merisier)

Colors shown / Couleurs montrées : Harley (51) / Sand dust (86)



Wood colors available / Couleurs de bois disponibles

Distressed solid wood / Bois massif usé

78	79	80	81	82	84	86	87	89	93	45
----	----	----	----	----	----	----	----	----	----	----

Non-distressed solid wood / Bois massif non usé

39	41	42	43	44	46	47	48	49	96	85
----	----	----	----	----	----	----	----	----	----	----

in/po	W/L	D/P	H	S
26B	18 1/2	20 3/4	41 1/4	25
30B	18 1/2	20 3/4	45 1/4	29

Diaz 41297

Boudoir

SWIVEL STOOL

(without memory return)
Upholstered seat and backrest with solid wood legs (birch) and metal footrest

TABOURET PIVOTANT

(sans mécanisme à mémoire)
Siège et dossier rembourrés avec pattes en bois massif (merisier) et appui-pied en métal

Colors shown / Couleurs montrées : Black coral / Noir corail (25) / Silverpoint (KZ) / Pine cone (96)



Wood colors available / Couleurs de bois disponibles

Non-distressed solid wood / Bois massif non usé

39	43	46	47	96
----	----	----	----	----

in/po	W/L	D/P	H	S	A
26	18 3/4	21 3/4	38 1/2	26 1/4	28
30	18 3/4	21 3/4	42 1/2	30 1/4	32

Dorsey 41596

Farmhouse

SWIVEL STOOL

(without memory return)
Upholstered seat and backrest with metal armrests

TABOURET PIVOTANT

(sans mécanisme à mémoire)
Siège et dossier rembourrés avec appuis-bras en métal

Colors shown / Couleurs montrées : Oxidado (52) / Shiitake (HT)



in/po	W/L	D/P	H	S	A
26	21 1/2	24	42	26	32 3/4
30	21 1/2	24	46	30	36 3/4
34	21 1/2	24	50	34 3/4	40 3/4

Easton 30535

Urban

CHAIR

Upholstered seat and backrest

CHAISE

Siège et dossier rembourrés

Colors shown / *Couleurs montrées* :
Magnetite (24) / Pixel (BP)



in/po	W/L	D/P	H	S
	22	20 3/4	31	18 3/4

Easton 41535

Urban

SWIVEL STOOL

(without memory return)

Upholstered seat and backrest

TABOURET PIVOTANT

(sans mécanisme à mémoire)

Siège et dossier rembourrés

Colors shown / *Couleurs montrées* :
Magnetite (24) / Pixel (BP)



in/po	W/L	D/P	H	S
26	22	20 3/4	37 1/4	27
30	22	20 3/4	41 1/4	31
34	22	20 3/4	45 1/4	35

Edwin 35198

Urban

CHAIR

Upholstered seat and metal backrest

CHAISE

Siège rembourré et dossier en métal

Colors shown / *Couleurs montrées* :
Oxidado (52) / Oyster (DB)



in/po	W/L	D/P	H	S
	19 1/2	21 1/4	37 5/8	19

Edwin 35198B

Industrial

CHAIR

Solid wood (birch) seat and metal backrest

CHAISE

Siège en bois massif (merisier) et dossier en métal

Colors shown / *Couleurs montrées* :
Oxidado (52) / Toasty (87)



Wood colors available / *Couleurs de bois disponibles*

Distressed solid wood / *Bois massif usé*

78	79	80	81	82	84	86	87	89	93	45
----	----	----	----	----	----	----	----	----	----	----

Non-distressed solid wood / *Bois massif non usé*

39	41	42	43	44	46	47	48	49	96	85
----	----	----	----	----	----	----	----	----	----	----

in/po	W/L	D/P	H	S
	19 1/2	21 3/8	37 5/8	17 1/8

Edwin 40198

Urban

NON SWIVEL STOOL

Upholstered seat and metal backrest

TABOURET NON PIVOTANT

Siège rembourré et dossier en métal

Colors shown/ Couleurs montrées : Magnetite (24)/Ink (DA)



in/po	W/L	D/P	H	S
26	19 1/2	21 1/4	40 1/2	26
30	19 1/2	21 1/2	44 1/2	30

Edwin 40198-B

Industrial

NON SWIVEL STOOL

Solid wood (birch) seat and metal backrest

TABOURET NON PIVOTANT

Siège en bois massif (merisier) et dossier en métal

Colors shown/ Couleurs montrées : Oxidado (52)/Toasty (87)



Wood colors available/ Couleurs de bois disponibles

Distressed solid wood/ Bois massif usé

78	79	80	81	82	84	86	87	89	93	45
----	----	----	----	----	----	----	----	----	----	----

Non-distressed solid wood/ Bois massif non usé

39	41	42	43	44	46	47	48	49	96	85
----	----	----	----	----	----	----	----	----	----	----

in/po	W/L	D/P	H	S
26B	19 1/2	21 3/8	40 1/2	24 1/8
30B	19 1/2	21 5/8	44 1/2	28 1/8

Edwin 41498

Urban

SWIVEL STOOL

(with memory return)
Upholstered seat and metal backrest

TABOURET PIVOTANT

(avec mécanisme à mémoire)
Siège rembourré et dossier en métal

Color shown/ Couleur montrée : Magnetite (24)/Navy (DF)



in/po	W/L	D/P	H	S
26	17 1/2	19 5/8	40 3/4	26 1/2
30	17 1/2	19 5/8	44 3/4	30 1/2
34	17 1/2	20 1/4	48 3/4	34 1/2

Edwin 41498-B

Industrial

SWIVEL STOOL

(with memory return)
Solid wood (birch) seat and metal backrest

TABOURET PIVOTANT

(avec mécanisme à mémoire)
Siège en bois massif (merisier) et dossier en métal

Colors shown/ Couleurs montrées : Oxidado (52)/Toasty (87)



Wood colors available/ Couleurs de bois disponibles

Distressed solid wood/ Bois massif usé

78	79	80	81	82	84	86	87	89	93	45
----	----	----	----	----	----	----	----	----	----	----

Non-distressed solid wood/ Bois massif non usé

39	41	42	43	44	46	47	48	49	96	85
----	----	----	----	----	----	----	----	----	----	----

in/po	W/L	D/P	H	S
26B	17 1/2	19 5/8	40 3/4	25 1/4
30B	17 1/2	19 5/8	44 3/4	29 1/4
34B	17 1/2	20 1/4	48 3/4	33 1/4

Eleanor 35210

Farmhouse

CHAIR

Upholstered seat and backrest with solid wood (birch) accent

CHAISE

Siège et dossier rembourrés avec accent en bois massif (merisier)

Colors shown / Couleurs montrées :
Oxidado (52) / Pebble (CB) /
Porter (44)



Wood colors available / Couleurs de bois disponibles

Distressed solid wood / Bois massif usé

78	79	80	81	82	84	86	87	89	93	45
----	----	----	----	----	----	----	----	----	----	----

Non-distressed solid wood / Bois massif non usé

39	41	42	43	44	46	47	48	49	96	85
----	----	----	----	----	----	----	----	----	----	----

in/po	W/L	D/P	H	S
	19 1/2	22 1/2	38	19

Eleanor 41410

Farmhouse

SWIVEL STOOL

(with memory return)
Upholstered seat and backrest with solid wood (birch) accent

TABOURET PIVOTANT

*(avec mécanisme à mémoire)
Siège et dossier rembourrés avec accent en bois massif (merisier)*

Colors shown / Couleurs montrées :
Oxidado (52) / Pebble (CB) /
Maroon (82)



Wood colors available / Couleurs de bois disponibles

Distressed solid wood / Bois massif usé

78	79	80	81	82	84	86	87	89	93	45
----	----	----	----	----	----	----	----	----	----	----

Non-distressed solid wood / Bois massif non usé

39	41	42	43	44	46	47	48	49	96	85
----	----	----	----	----	----	----	----	----	----	----

in/po	W/L	D/P	H	S
26	18	20	44	26 1/2
30	18	20	48	30 1/2
34	18	21 1/2	52	34 1/2

Essie 30343

Urban

NEW

CHAIR

Upholstered seat and backrest

NOUVEAU

CHAISE

Siège et dossier rembourrés

Colors shown / Couleurs montrées :
Black coral / Noir corail (25) /
Iceberg (MB)



in/po	W/L	D/P	H	S
	21 1/4	24 1/4	32 3/4	19

Esteban 41273

Industrial

SWIVEL STOOL

(without memory return)
Upholstered seat with solid wood legs and backrest (birch) and metal footrest

TABOURET PIVOTANT

*(sans mécanisme à mémoire)
Siège rembourré avec pattes et dossier en bois massif (merisier) et appui-pied en métal*

Colors shown / Couleurs montrées :
Black coral / Noir corail (25) /
Marshmallow (DX) / Café (43)



Wood colors available / Couleurs de bois disponibles

Non-distressed solid wood / Bois massif non usé

39	43	46	47	96
----	----	----	----	----

in/po	W/L	D/P	H	S
26	17	20	37	26
30	18	20 1/2	41	30

Esteban 41273-B

Industrial

SWIVEL STOOL
(without memory return)
Solid wood (birch) seat and backrest with solid wood legs (birch) and metal footrest

TABOURET PIVOTANT
(sans mécanisme à mémoire)
Siège et dossier avec pattes en bois massif (merisier) et appui-pied en métal

Colors shown/ Couleurs montrées :
Harley (51)/ Tiramisu (47)



Wood colors available/ Couleurs de bois disponibles
Non-distressed solid wood/Bois massif non usé

39 43 46 47 96

in/po	W/L	D/P	H	S
26B	17	20	37	25
30B	18	20 1/2	41	29

Ethan 45308

Boudoir

NON SWIVEL STOOL
Upholstered seat and backrest

TABOURET NON PIVOTANT
Siège et dossier rembourrés

Colors shown/ Couleurs montrées :
Oxidado (52)/ Shiitake (HT)



in/po	W/L	D/P	H	S
26	17 1/2	21 1/2	34	26 1/4
30	17 1/2	21 1/2	38	30 1/4

Ethan Plus 45309

Urban

NON SWIVEL STOOL
Upholstered seat and backrest

TABOURET NON PIVOTANT
Siège et dossier rembourrés

Colors shown/ Couleurs montrées :
Metallo (57)/ Flame (HB)



in/po	W/L	D/P	H	S
26	19 1/2	22 1/2	34	26 1/4
30	19 1/2	22 1/2	38	30 1/4

Fame 41468

Urban

SWIVEL STOOL
(without memory return)
Upholstered seat and backrest

TABOURET PIVOTANT
(sans mécanisme à mémoire)
Siège et dossier rembourrés

Colors shown/ Couleurs montrées :
Magnetite (24)/ Oyster (DB)



in/po	W/L	D/P	H	S
26	17 3/4	19 3/4	37 1/2	26
30	17 3/4	19 3/4	41 1/2	30
34	17 3/4	19 3/4	45 1/2	34

Fletcher 41212

Nordic

SWIVEL STOOL

(without memory return)
Solid wood legs (birch) and metal footrest with upholstered seat and backrest

TABOURET PIVOTANT

(sans mécanisme à mémoire)
Siège et dossier rembourrés avec pattes en bois massif (merisier) et appui-pied en métal

Colors shown / Couleurs montrées :
Black coral / Noir corail (25) / Pixel (BP) / Café (43)



Wood colors available / Couleurs de bois disponibles

Non-distressed solid wood / Bois massif non usé

39 43 46 47 96

in/po	W/L	D/P	H	S	A
26	22	19 1/4	34	26 1/4	34
30	22	19 1/4	38	30 1/4	38

Fred 40044

Urban

NEW

NON SWIVEL STOOL

Upholstered seat

NOUVEAU

TABOURET NON PIVOTANT

Siège rembourré

Colors shown / Couleurs montrées :
Black coral / Noir corail (25) / Dolphin (GS)



in/po	W/L	D/P	H	S
26	15	15	26 3/4	26 3/4
30	15	15	30 3/4	30 3/4

Fred 40044-B

Urban

NEW

NON SWIVEL STOOL

Solid wood (birch) seat

NOUVEAU

TABOURET NON PIVOTANT

Siège en bois massif (merisier)

Colors shown / Couleurs montrées :
Oxidado (52) / Sand dust (86)



Wood colors available / Couleurs de bois disponibles

Distressed solid wood / Bois massif usé

78 79 80 81 82 84 86 87 89 93 45

Non-distressed solid wood / Bois massif non usé

39 41 42 43 44 46 47 48 49 96 85

in/po	W/L	D/P	H	S
26B	15	15	25 1/2	25 1/2
30B	15	15	29 1/2	29 1/2

Garden 41488

Countryside

SWIVEL STOOL

(without memory return)
Upholstered seat and metal backrest

TABOURET PIVOTANT

(sans mécanisme à mémoire)
Siège rembourré et dossier en métal

Color shown / Couleur montrée :
Cobrizo (75) / Limestone (EV)



in/po	W/L	D/P	H	S
26	17 3/4	19 1/4	42 3/4	27 5/8
30	17 3/4	19 1/4	46 3/4	31 5/8
34	17 3/4	19 1/4	49 3/4	34 5/8

Giulia 30537

Boudoir

SWIVEL CHAIR
(with memory return)
Upholstered seat and backrest

CHAISE PIVOTANTE
(avec mécanisme à mémoire)
Siège et dossier rembourrés

Colors shown / Couleurs montrées :
Black coral / Noir corail (25)
Silverpoint (KZ)



in/po	W/L	D/P	H	S
	18 3/4	21 3/4	31	18 1/2

Gladys 30337

Urban

CHAIR
Upholstered seat and backrest

CHAISE
Siège et dossier rembourrés

Colors shown / Couleurs montrées :
Titanium (56) / Sheep (JU)



in/po	W/L	D/P	H	S
	18 3/4	21 3/4	31 3/4	19 1/4

Glenn 41597

Boudoir

SWIVEL STOOL
(without memory return)
Upholstered seat
and backrest

TABOURET PIVOTANT
(sans mécanisme à mémoire)
Siège et dossier rembourrés

Colors shown / Couleurs montrées :
Sun gold (27) / Emerald (JL)



in/po	W/L	D/P	H	S
26	18 3/4	21	38 1/4	26 1/4
30	18 3/4	21	42 1/2	30 1/4

Glenn 42597

Boudoir

SWIVEL STOOL
(without memory return)
Upholstered seat

TABOURET PIVOTANT
(sans mécanisme à mémoire)
Siège rembourré

Colors shown / Couleurs montrées :
Sun gold (27) / Emerald (JL)



in/po	W/L	D/P	H	S
26	18 5/8	18 5/8	26	26
30	18 5/8	18 5/8	30	30

Glint 42495

Urban

SWIVEL STOOL
(without memory return)
Upholstered seat

TABOURET PIVOTANT
(sans mécanisme à mémoire)
Siège rembourré

Colors shown/ Couleurs montrées :
Magnetite (24)/Blizzard (DH)



in/po	W/L	D/P	H	S
26	18	18	26	26
30	18	18	30	30

Grace 42414

Countryside

SWIVEL STOOL
(without memory return)
Upholstered seat

TABOURET PIVOTANT
(sans mécanisme à mémoire)
Siège rembourré

Colors shown/ Couleurs montrées :
Oxidado (52)/Oyster (DB)



in/po	W/L	D/P	H	S
26	16 1/8	16 1/8	27 1/4	27 1/4
30	17 1/8	17 1/8	31 1/4	31 1/4
34	18 1/8	18 1/8	35	35

Grace 42414-B

Industrial

SWIVEL STOOL
(without memory return)
Solid wood (birch) seat

TABOURET PIVOTANT
(sans mécanisme à mémoire)
Siège en bois massif (merisier)

Colors shown/ Couleurs montrées :
Oxidado (52)/Toasty (87)



Wood colors available/ Couleurs de bois disponibles
Distressed solid wood/Bois massif usé

78	79	80	81	82	84	86	87	89	93	45
----	----	----	----	----	----	----	----	----	----	----

Non-distressed solid wood/Bois massif non usé

39	41	42	43	44	46	47	48	49	96	85
----	----	----	----	----	----	----	----	----	----	----

in/po	W/L	D/P	H	S
26B	16 1/8	16 1/8	26	26
30B	17 1/8	17 1/8	30	30
34B	18 1/8	18 1/8	34	34

Grissom 30560

Nordic

CHAIR
Upholstered seat and backrest

CHAISE
Siège et dossier rembourrés

Colors shown/ Couleurs montrées :
Black coral/Noir corail (25)/
Volcano (CP)



in/po	W/L	D/P	H	S	A
	22	23 1/4	34	20 3/4	29 3/4

Grissom Plus 30561 Nordic

CHAIR
Upholstered seat and backrest

CHAISE
Siège et dossier rembourrés

Colors shown/ *Couleurs montrées* :
Black coral/ *Noir corail* (25)/
Cemento (EL)



in/po	W/L	D/P	H	S	A
	24	25 1/4	34	20 3/4	29 3/4

Grissom 41560 Nordic

SWIVEL STOOL
(without memory return)
Upholstered seat and backrest

TABOURET PIVOTANT
(sans mécanisme à mémoire)
Siège et dossier rembourrés

Colors shown/ *Couleurs montrées* :
Black coral/ *Noir corail* (25)/
Cemento (EL)



in/po	W/L	D/P	H	S	A
26	22	23 1/4	40 3/4	27 1/2	37 1/4
30	22	23 1/4	44 3/4	31 1/2	41 1/4
34	22	23 1/4	48 3/4	35 1/2	45 1/4

Hans 42504 Urban

SWIVEL STOOL
(without memory return)
Upholstered seat

TABOURET PIVOTANT
(sans mécanisme à mémoire)
Siège rembourré

Colors shown/ *Couleurs montrées* :
Magnetite (24)/Oceanic (JM)



in/po	W/L	D/P	H	S
26	16 1/4	16 1/4	26 5/8	26 5/8
30	17 1/4	17 1/4	30 5/8	30 5/8

Hans 42504-B Urban

SWIVEL STOOL
(without memory return)
Solid wood (birch) seat

TABOURET PIVOTANT
(sans mécanisme à mémoire)
Siège en bois massif (merisier)

Colors shown/ *Couleurs montrées* :
Pure (61)/Stone dust (89)



Wood colors available/ *Couleurs de bois disponibles*
Distressed solid wood/ *Bois massif usé*

78	79	80	81	82	84	86	87	89	93	45
----	----	----	----	----	----	----	----	----	----	----

Non-distressed solid wood/ *Bois massif non usé*

39	41	42	43	44	46	47	48	49	96	85
----	----	----	----	----	----	----	----	----	----	----

in/po	W/L	D/P	H	S
26B	16 1/4	16 1/4	25 5/8	25 5/8
30B	17 1/4	17 1/4	29 5/8	29 5/8

Hanson 45409

Urban

NON SWIVEL STOOL

Upholstered seat and backrest

TABOURET NON PIVOTANT

Siège et dossier rembourrés

Colors shown / Couleurs montrées : Metallo (57) / Merino (JT)



in/po	W/L	D/P	H	S
26	17 1/2	21 1/2	34 1/4	26 7/8
30	17 1/2	21 1/2	38 1/4	30 7/8

Hanson Plus 45405

Urban

NON SWIVEL STOOL

Upholstered seat and backrest

TABOURET NON PIVOTANT

Siège et dossier rembourrés

Colors shown / Couleurs montrées : Cobrizo (75) / Parchment (GT)



in/po	W/L	D/P	H	S
26	19 1/2	22 1/2	34 1/4	26 7/8
30	19 1/2	22 1/2	38 1/4	30 7/8

Hint 30202

Nordic

CHAIR

Upholstered seat and wood veneer backrest (birch)

CHAISE

Siège rembourré et dossier en placage de bois (merisier)

Colors shown / Couleurs montrées : Oxidado (52) / Caramelo (ER) / Tiramisu (47)



Wood veneer colors available / Couleurs de placage de bois disponibles

39	41	42	43	44	46	47	48	49	96	85
----	----	----	----	----	----	----	----	----	----	----

in/po	W/L	D/P	H	S
	17 1/2	19 1/2	31 3/4	18 3/4

Hint 40202

Nordic

NON SWIVEL STOOL

Upholstered seat and wood veneer backrest (birch)

TABOURET NON PIVOTANT

Siège rembourré et dossier en placage de bois (merisier)

Colors shown / Couleurs montrées : Oxidado (52) / Caramelo (ER) / Tiramisu (47)



Wood veneer colors available / Couleurs de placage de bois disponibles

39	41	42	43	44	46	47	48	49	96	85
----	----	----	----	----	----	----	----	----	----	----

in/po	W/L	D/P	H	S
26	17 1/2	20 1/4	37 1/2	26 1/2
30	17 1/2	20 1/4	41 1/2	30 1/2

Jonas 30137

Urban

ARMCHAIR

(padded armrests)
Upholstered seat and backrest

CHAISE AVEC BRAS

(accoudoirs rembourrés)
Siège et dossier rembourrés

Colors shown / Couleurs montrées :
Black coral / Noir corail (25) /
Cloud (HF)



in/po	W/L	D/P	H	S	A
	24	23	32	18 1/4	24

Jonas 41437

Urban

SWIVEL STOOL

(without memory return)
Upholstered seat and backrest
with metal armrests

TABOURET PIVOTANT

(sans mécanisme à mémoire)
Siège et dossier rembourrés
avec appuis-bras en métal

Colors shown / Couleurs montrées :
Black coral / Noir corail (25) /
Dolphin (GS)



in/po	W/L	D/P	H	S	A
26	24	22 3/4	40	26	31 1/2
30	24	22 3/4	44	30	35 1/2

Joshua 41239

Nordic

SWIVEL STOOL

(without memory return)
Solid wood base (birch)
with upholstered seat,
backrest and armrests

TABOURET PIVOTANT

(sans mécanisme à mémoire)
Base en bois massif (merisier)
avec siège, dossier et
appuis-bras rembourrés

Colors shown / Couleurs montrées :
Pine cone (96) / Sleet (BA)



Wood colors available / Couleurs de bois disponibles

47	48	96
----	----	----

in/po	W/L	D/P	H	S	A
26	25 3/4	21 3/4	39 1/4	26 1/2	35
30	25 3/4	21 3/4	43 1/4	30 1/2	39

Kent 41528

Industrial

SWIVEL STOOL

(without memory return)
Upholstered seat and
metal backrest

TABOURET PIVOTANT

(sans mécanisme à mémoire)
Siège rembourré et
dossier en métal

Colors shown / Couleurs montrées :
Black coral / Noir corail (25) /
Elephant (DN)



in/po	W/L	D/P	H	S
26	17 3/4	21 5/8	42 1/4	26 1/2
30	17 3/4	21 5/8	46 1/4	30 1/2

Kent 41528-B

Industrial

SWIVEL STOOL

(without memory return)
Solid wood (birch) seat and metal backrest

TABOURET PIVOTANT

(sans mécanisme à mémoire)
Siège en bois massif (merisier) et dossier en métal

Colors shown / Couleurs montrées :
Black coral / Noir corail (25) /
Stone dust (89)



Wood colors available / Couleurs de bois disponibles

Distressed solid wood / Bois massif usé

78	79	80	81	82	84	86	87	89	93	45
----	----	----	----	----	----	----	----	----	----	----

Non-distressed solid wood / Bois massif non usé

39	41	42	43	44	46	47	48	49	96	85
----	----	----	----	----	----	----	----	----	----	----

in/po	W/L	D/P	H	S
26B	17 3/4	21 5/8	42 1/4	25 1/4
30B	17 3/4	21 5/8	46 1/4	29 1/4

Kyle 35214

Industrial

CHAIR

Upholstered seat and metal backrest with solid wood (birch) accent

CHAISE

Siège rembourré et dossier en métal avec accent en bois massif (merisier)

Colors shown / Couleurs montrées :
Oxidado (52) / Floeberg (KM) /
Porter (44)



Wood colors available / Couleurs de bois disponibles

Distressed solid wood / Bois massif usé

78	79	80	81	82	84	86	87	89	93	45
----	----	----	----	----	----	----	----	----	----	----

Non-distressed solid wood / Bois massif non usé

39	41	42	43	44	46	47	48	49	96	85
----	----	----	----	----	----	----	----	----	----	----

in/po	W/L	D/P	H	S
	19 1/2	22 1/4	38	19

Kyle 35214B

Industrial

CHAIR

Solid wood (birch) seat and accent with metal backrest

CHAISE

Siège et accent en bois massif (merisier) avec dossier en métal

Colors shown / Couleurs montrées :
Oxidado (52) / Toasty (87)



Wood colors available / Couleurs de bois disponibles

Distressed solid wood / Bois massif usé

78	79	80	81	82	84	86	87	89	93	45
----	----	----	----	----	----	----	----	----	----	----

Non-distressed solid wood / Bois massif non usé

39	41	42	43	44	46	47	48	49	96	85
----	----	----	----	----	----	----	----	----	----	----

in/po	W/L	D/P	H	S
	19 1/2	22 3/8	38	17 1/8

Kyle 40224

Industrial

NON SWIVEL STOOL

Upholstered seat and metal backrest with solid wood (birch) accent

TABOURET

NON PIVOTANT

Siège rembourré et dossier en métal avec accent en bois massif (merisier)

Colors shown / Couleurs montrées :
Oxidado (52) / Floeberg (KM) /
Tiramisu (47)



Wood colors available / Couleurs de bois disponibles

Distressed solid wood / Bois massif usé

78	79	80	81	82	84	86	87	89	93	45
----	----	----	----	----	----	----	----	----	----	----

Non-distressed solid wood / Bois massif non usé

39	41	42	43	44	46	47	48	49	96	85
----	----	----	----	----	----	----	----	----	----	----

in/po	W/L	D/P	H	S
26	19 1/2	22 1/2	41 1/4	26
30	19 1/2	22 1/2	45 1/4	30

Kyle 40224-B

Industrial

NON SWIVEL STOOL

Solid wood (birch) seat and accent with metal backrest

TABOURET NON PIVOTANT

Siège et accent en bois massif (merisier) avec dossier en métal

Colors shown / Couleurs montrées : Oxidado (52) / Toasty (87)



Wood colors available / Couleurs de bois disponibles

Distressed solid wood / Bois massif usé

78	79	80	81	82	84	86	87	89	93	45
----	----	----	----	----	----	----	----	----	----	----

Non-distressed solid wood / Bois massif non usé

39	41	42	43	44	46	47	48	49	96	85
----	----	----	----	----	----	----	----	----	----	----

in/po	W/L	D/P	H	S
26B	19 1/2	22 5/8	41 1/4	24 1/8
30B	19 1/2	22 5/8	45 1/4	28 1/8

Kyle 41414

Industrial

SWIVEL STOOL

(with memory return)
Upholstered seat and metal backrest with solid wood (birch) accent

TABOURET PIVOTANT

(avec mécanisme à mémoire)
Siège rembourré et dossier en métal avec accent en bois massif (merisier)

Colors shown / Couleurs montrées : Metallo (57) / Cemento (EL) / Tiramisu (47)



Wood colors available / Couleurs de bois disponibles

Distressed solid wood / Bois massif usé

78	79	80	81	82	84	86	87	89	93	45
----	----	----	----	----	----	----	----	----	----	----

Non-distressed solid wood / Bois massif non usé

39	41	42	43	44	46	47	48	49	96	85
----	----	----	----	----	----	----	----	----	----	----

in/po	W/L	D/P	H	S
26	17 1/2	21	43 5/8	26 1/2
30	17 1/2	21	47 5/8	30 1/2
34	17 1/2	21 1/2	52 1/4	34 1/2

Kyle 41414-B

Industrial

SWIVEL STOOL

(with memory return)
Solid wood (birch) seat and accent with metal backrest

TABOURET PIVOTANT

(avec mécanisme à mémoire)
Siège et accent en bois massif (merisier) avec dossier en métal

Colors shown / Couleurs montrées : Oxidado (52) / Toasty (87)



Wood colors available / Couleurs de bois disponibles

Distressed solid wood / Bois massif usé

78	79	80	81	82	84	86	87	89	93	45
----	----	----	----	----	----	----	----	----	----	----

Non-distressed solid wood / Bois massif non usé

39	41	42	43	44	46	47	48	49	96	85
----	----	----	----	----	----	----	----	----	----	----

in/po	W/L	D/P	H	S
26B	17 1/2	21	43 5/8	25 1/4
30B	17 1/2	21	47 5/8	29 1/4
34B	17 1/2	21 1/2	52 1/4	33 1/4

Lance 41436

Urban

SWIVEL STOOL

(without memory return)
Upholstered seat and backrest with metal armrests

TABOURET PIVOTANT

(sans mécanisme à mémoire)
Siège et dossier rembourrés avec appuis-bras en métal

Colors shown / Couleurs montrées : Metallo (57) / Ink (DA)



in/po	W/L	D/P	H	S	A
26	22 1/2	23 1/4	40 5/8	26 7/8	34 5/8
30	22 1/2	23 1/4	44 5/8	30 7/8	38 5/8
34	22 1/2	23 1/4	48 5/8	34 5/8	42 5/8



Lauren 30293

Urban

CHAIR

Upholstered seat and wood veneer backrest (birch)

CHAISE

Siège rembourré et dossier en placage de bois (merisier)

Colors shown / Couleurs montrées : Metallo (57) / Coal (HC) / Porter (44)



Wood veneer colors available / Couleurs de placage de bois disponibles

39	41	42	43	44	46	47	48	49	96	85
----	----	----	----	----	----	----	----	----	----	----

in/po	W/L	D/P	H	S
	17 3/4	19 3/8	31	19

Lauren 30493

Urban

CHAIR

Upholstered seat and stainless steel backrest

CHAISE

Siège rembourré et dossier en acier inoxydable

Colors shown / Couleurs montrées : Metallo (57) / Coal (HC)



in/po	W/L	D/P	H	S
	17 3/4	19 3/8	31	19

Lauren 30593

Industrial

CHAIR

Upholstered seat and metal backrest

CHAISE

Siège rembourré et dossier en métal

Colors shown / Couleurs montrées : Harley (51) / Elephant (DN)



in/po	W/L	D/P	H	S
	17 3/4	19 3/8	31	19

Lauren 30593B

Industrial

CHAIR

Solid wood (birch) seat and metal backrest

CHAISE

Siège en bois massif (merisier) et dossier en métal

Colors shown / Couleurs montrées : Harley (51) / Shady (84)



Wood colors available / Couleurs de bois disponibles

Distressed solid wood / Bois massif usé

78	79	80	81	82	84	86	87	89	93	45
----	----	----	----	----	----	----	----	----	----	----

Non-distressed solid wood / Bois massif non usé

39	41	42	43	44	46	47	48	49	96	85
----	----	----	----	----	----	----	----	----	----	----

in/po	W/L	D/P	H	S
	17 3/4	19 3/8	31	17 3/4

Lauren 40293

Urban

SWIVEL STOOL
(without memory return)
Upholstered seat and wood
vener backrest (birch)

TABOURET PIVOTANT
(sans mécanisme à mémoire)
Siège rembourré et dossier en
placage de bois (merisier)

Colors shown / Couleurs montrées :
Metallo (57)/Volcano (CP)/
Mouse (49)



Wood veneer colors available / Couleurs de placage de bois disponibles

39	41	42	43	44	46	47	48	49	96	85
----	----	----	----	----	----	----	----	----	----	----

in/po	W/L	D/P	H	S
26	17 1/2	19 1/2	35 1/2	26 1/4
30	17 1/2	19 1/2	39 1/2	30 1/4
34	18 3/4	19 1/2	43 5/8	34

Lauren 40493

Urban

SWIVEL STOOL
(without memory return)
Upholstered seat and stainless
steel backrest

TABOURET PIVOTANT
(sans mécanisme à mémoire)
Siège rembourré et dossier en
acier inoxydable

Colors shown / Couleurs montrées :
Black coral/Noir corail (25)/
Silverpoint (KZ)



in/po	W/L	D/P	H	S
26	17 1/2	19 1/2	35 1/2	26 1/4
30	17 1/2	19 1/2	39 1/2	30 1/4
34	18 3/4	19 1/2	43 5/8	34

Lauren 40593

Industrial

SWIVEL STOOL
(without memory return)
Upholstered seat and
metal backrest

TABOURET PIVOTANT
(sans mécanisme à mémoire)
Siège rembourré et dossier
en métal

Colors shown / Couleurs montrées :
Harley (51)/Elephant (DN)



in/po	W/L	D/P	H	S
26	17 1/2	19 1/2	35 1/2	26 1/4
30	17 1/2	19 1/2	39 1/2	30 1/4
34	18 3/4	19 1/2	43 5/8	34

Lauren 40593-B

Industrial

SWIVEL STOOL
(without memory return)
Solid wood (birch) seat
and metal backrest

TABOURET PIVOTANT
(sans mécanisme à mémoire)
Siège en bois massif (merisier)
et dossier en métal

Colors shown / Couleurs montrées :
Harley (51)/Shady (84)



Wood colors available / Couleurs de bois disponibles
Distressed solid wood / Bois massif usé

78	79	80	81	82	84	86	87	89	93	45
----	----	----	----	----	----	----	----	----	----	----

Non-distressed solid wood / Bois massif non usé

39	41	42	43	44	46	47	48	49	96	85
----	----	----	----	----	----	----	----	----	----	----

in/po	W/L	D/P	H	S
26B	17 1/2	19 1/2	35 1/2	25 1/2
30B	17 1/2	19 1/2	39 1/2	29 1/2
34B	18 3/4	19 1/2	43 5/8	33 1/4

Leo 35305

Boudoir

CHAIR

Upholstered seat and backrest

CHAISE

Siège et dossier rembourrés

Colors shown / *Couleurs montrées* :
Oxidado (52) / Oyster (DB)



in/po	W/L	D/P	H	S
	19 1/2	26 1/4	40 1/4	18 3/4

Level 30325

Urban

CHAIR

Upholstered seat and metal backrest

CHAISE

Siège rembourré et dossier en métal

Colors shown / *Couleurs montrées* :
Magnetite (24) / Volcano (CP)



in/po	W/L	D/P	H	S
	18 1/4	22	38 1/4	18

Level 41325

Urban

SWIVEL STOOL

(without memory return)
Upholstered seat and metal backrest

TABOURET PIVOTANT

(sans mécanisme à mémoire)
Siège rembourré et dossier en métal

Colors shown / *Couleurs montrées* :
Magnetite (24) / Blizzard (DH)



in/po	W/L	D/P	H	S
26	16 1/2	20 3/8	38 1/2	26
30	17 3/8	20 1/2	42 1/2	30

Lincoln 41478

Urban

SWIVEL STOOL

(without memory return)
Upholstered seat and metal backrest

TABOURET PIVOTANT

(sans mécanisme à mémoire)
Siège rembourré et dossier en métal

Colors shown / *Couleurs montrées* :
Magnetite (24) / Blizzard (DH)



in/po	W/L	D/P	H	S
26	18	19 3/4	37 5/8	26
30	18	19 3/4	41 5/8	30

Linea 30320

Urban

CHAIR

Upholstered seat and backrest

CHAISE

Siège et dossier rembourrés

Colors shown/ *Couleurs montrées* :
Magnetite (24)/Nova (E8)



in/po	W/L	D/P	H	S
	18 1/4	21 1/2	36 7/8	18

Linea 40320

Urban

NON SWIVEL STOOL

Upholstered seat and backrest

TABOURET

NON PIVOTANT

Siège et dossier rembourrés

Colors shown/ *Couleurs montrées* :
Black coral/ *Noir corail* (25)/
Oyster (DB)



in/po	W/L	D/P	H	S
26	16 1/2	20	38 7/8	26 1/8
30	16 1/2	20	42 7/8	30 1/8

Linea 41320

Urban

SWIVEL STOOL

(without memory return)

Upholstered seat and backrest

TABOURET PIVOTANT

(sans mécanisme à mémoire)

Siège et dossier rembourrés

Colors shown/ *Couleurs montrées* :
Magnetite (24)/Marshmallow (DX)



in/po	W/L	D/P	H	S
26	16 1/2	20 3/8	39	26
30	17 3/8	20 1/2	43	30

Linea 41321

Urban

SWIVEL STOOL

(low backrest)

(without memory return)

Upholstered seat and backrest

TABOURET PIVOTANT

(dossier bas)

(sans mécanisme à mémoire)

Siège et dossier rembourrés

Colors shown/ *Couleurs montrées* :
Pure (61)/Breezy (JS)



in/po	W/L	D/P	H	S
26	16 1/2	18 3/4	32 1/2	26
30	17 3/8	19 1/4	36 1/2	30

Luna 30317

Urban

CHAIR

Upholstered seat and backrest

CHAISE

Siège et dossier rembourrés

Colors shown / *Couleurs montrées* :
Magnetite (24) / Cloud (HF)



in/po	W/L	D/P	H	S
	18 1/4	21 1/2	36 7/8	18

Luna 40317

Urban

NON SWIVEL STOOL

Upholstered seat and backrest

TABOURET

NON PIVOTANT

Siège et dossier rembourrés

Colors shown / *Couleurs montrées* :
Magnetite (24) / Fossil (JO)



in/po	W/L	D/P	H	S
26	16 1/2	20	38 7/8	26 1/8
30	16 1/2	20	42 7/8	30 1/8

Luna 41317

Urban

SWIVEL STOOL

(without memory return)

Upholstered seat and backrest

TABOURET PIVOTANT

(sans mécanisme à mémoire)

Siège et dossier rembourrés

Colors shown / *Couleurs montrées* :
Magnetite (24) / Tuxedo (JQ)



in/po	W/L	D/P	H	S
26	16 1/2	20 3/8	39	26
30	17 3/8	20 1/2	43	30

Maddie 30341

Farmhouse

CHAIR

Upholstered seat and backrest

CHAISE

Siège et dossier rembourrés

Colors shown / *Couleurs montrées* :
Black coral / *Noir corail* (25)
Sheep (JU)



in/po	W/L	D/P	H	S
	19	23 1/8	37	18

Madison 41406

Countryside

SWIVEL STOOL

(with memory return)
Upholstered seat and metal
backrest with wood veneer
accent (birch)

TABOURET PIVOTANT

(avec mécanisme à mémoire)
Siège rembourré et dossier en
métal avec accent en placage de
bois (merisier)

Colors shown / Couleurs montrées :
Black coral / Noir corail (25)/
Stratus (DD) / Café (43)



Wood veneer colors available / Couleurs de placage de bois disponibles

39	41	42	43	44	46	47	48	49	96	85
----	----	----	----	----	----	----	----	----	----	----

in/po	W/L	D/P	H	S
26	17 1/2	20 1/4	40 1/4	26 3/4
30	17 1/2	20 1/4	44 1/4	30 3/4
34	18 3/4	21 1/4	48	34 1/2

Marcus 30151

Countryside

CHAIR

Upholstered seat and
metal backrest

CHAISE

Siège rembourré et dossier
en métal

Colors shown / Couleurs montrées :
Titanium (56) / Pebble (CB)



in/po	W/L	D/P	H	S
	17 1/2	21 1/2	34 1/4	19 1/4

Marcus 41451

Countryside

SWIVEL STOOL

(without memory return)
Upholstered seat and
metal backrest

TABOURET PIVOTANT

(sans mécanisme à mémoire)
Siège rembourré et dossier
en métal

Colors shown / Couleurs montrées :
Cobrizo (75) / Morille (DW)



in/po	W/L	D/P	H	S
26	17 3/4	19 1/4	42 3/4	27 5/8
30	17 3/4	19 1/4	46 3/4	31 5/8
34	17 3/4	19 1/4	49 3/4	34 5/8

Marlon 35409

Urban

CHAIR

Upholstered seat and backrest

CHAISE

Siège et dossier rembourrés

Colors shown / Couleurs montrées :
Titanium (56) / Slate (HD)



in/po	W/L	D/P	H	S
	17 1/2	23 1/2	38 1/2	18 3/4

Mathilde 30340

Farmhouse

CHAIR

Upholstered seat and backrest

CHAISE

Siège et dossier rembourrés

Colors shown / *Couleurs montrées* :
Oxidado (52) / Complicity (KL)



in/po	W/L	D/P	H	S
	18 1/2	22 1/2	36 1/4	19 1/4

Mathilde 40340

Farmhouse

NON SWIVEL STOOL

Upholstered seat and backrest

TABOURET

NON PIVOTANT

Siège et dossier rembourrés

Colors shown / *Couleurs montrées* :
Oxidado (52) / Complicity (KL)



in/po	W/L	D/P	H	S
26	18 1/2	22 1/2	40 3/4	26 1/4
30	18 1/2	22 1/2	44 3/4	30 1/4

Melrose 35408

Urban

CHAIR

Upholstered seat and backrest

CHAISE

Siège et dossier rembourrés

Colors shown / *Couleurs montrées* :
Titanium (56) / Slate (HD)



in/po	W/L	D/P	H	S
	17 1/2	22 1/2	33 1/2	18 3/4

Melrose 45408

Urban

NON SWIVEL STOOL

Upholstered seat and backrest

TABOURET NON

PIVOTANT

Siège et dossier rembourrés

Colors shown / *Couleurs montrées* :
Titanium (56) / Slate (HD)



in/po	W/L	D/P	H	S
26	17 1/2	23	41 1/2	26 7/8
30	17 1/2	23	45 1/2	30 7/8

Merlot 30322

Countryside

CHAIR

Upholstered seat and backrest

CHAISE

Siège et dossier rembourrés

Colors shown / *Couleurs montrées* :
Mineral (73) / Oyster (DB)



in/po	W/L	D/P	H	S
	18 1/4	22	39 1/2	18 3/8

Milanos 30350

Boudoir

CHAIR

Upholstered seat and backrest
with metal armrests

CHAISE

*Siège et dossier rembourrés
avec appuis-bras en métal*

Colors shown / *Couleurs montrées* :
Magnetite (24) / Boardwalk (KX)



in/po	W/L	D/P	H	S
	21 1/4	23 1/2	35 1/4	19 1/2

Milanos 40350

Boudoir

NON SWIVEL STOOL

Upholstered seat and backrest
with metal armrests

TABOURET NON PIVOTANT

*Siège et dossier rembourrés
avec appuis-bras en métal*

Colors shown / *Couleurs montrées* :
Black coral / *Noir corail* (25) /
Tuxedo (JQ)



in/po	W/L	D/P	H	S	A
26	21 1/2	22 1/2	37 3/4	27 1/4	31
30	21 1/2	22 1/2	41 3/4	31 1/4	35

Miller 40035

Farmhouse

NON SWIVEL STOOL

Upholstered seat

TABOURET NON PIVOTANT

Siège rembourré

Colors shown / *Couleurs montrées* :
Oxidado (52) / Stratus (DD)



in/po	W/L	D/P	H	S
26	20	14 3/4	26 3/4	26 3/4
30	20	14 3/4	30 3/4	30 3/4



Mitchell 35405

Urban

CHAIR

Upholstered seat and backrest

CHAISE

Siège et dossier rembourrés

Colors shown / *Couleurs montrées* :
Titanium (56) / Slate (HD)



in/po	W/L	D/P	H	S
	19 1/2	26 1/4	40 1/4	18 1/2

Monroe 35404

Urban

CHAIR

Upholstered seat and backrest

CHAISE

Siège et dossier rembourrés

Colors shown / *Couleurs montrées* :
Titanium (56) / Slate (HD)



in/po	W/L	D/P	H	S
	19 1/2	24	33 1/4	18 3/4

Monroe 45404

Urban

NON SWIVEL STOOL

Upholstered seat and backrest

TABOURET

NON PIVOTANT

Siège et dossier rembourrés

Colors shown / *Couleurs montrées* :
Titanium (56) / Slate (HD)



in/po	W/L	D/P	H	S
26	19 1/2	24	41 1/2	26 7/8
30	19 1/2	24	45 1/2	30 7/8

Nathan 40033

Urban

NON SWIVEL STOOL

Upholstered seat

TABOURET

NON PIVOTANT

Siège rembourré

Colors shown / *Couleurs montrées* :
Black coral / *Noir corail* (25) /
Darkness (EU)



in/po	W/L	D/P	H	S
26	20 5/8	15 7/8	27	26
30	20 5/8	16 3/8	31	30

Nestor 30348

Nordic

NEW
CHAIR

Upholstered seat and metal backrest

NOUVEAU
CHAISE

Siège rembourré et dossier en métal

Colors shown/ Couleurs montrées :
Black coral/ Noir corail (25)/
Clove (LB)



in/po	W/L	D/P	H	S	A
	19 1/4	25 1/4	32 1/2	18 1/4	30

Nestor 40348

Nordic

NEW
NON SWIVEL STOOL
Upholstered seat and metal backrest

NOUVEAU
TABOURET
NON PIVOTANT

Siège rembourré et dossier en métal

Colors shown/ Couleurs montrées :
Black coral/ Noir corail (25)/
Clove (LB)



in/po	W/L	D/P	H	S	A
26	19 1/4	21 3/4	40 1/2	26 1/2	38
30	19 1/4	22	44 1/2	30 1/2	42

Niles 30351

Boudoir

CHAIR

Upholstered seat and backrest

CHAISE

Siège et dossier rembourrés

Colors shown/ Couleurs montrées :
Magnetite (24)/ Boardwalk (KX)



in/po	W/L	D/P	H	S
	19	23 1/4	36	19 1/2

Niles 41351

Boudoir

SWIVEL STOOL

(without memory return)

Upholstered seat and backrest

TABOURET PIVOTANT

(sans mécanisme à mémoire)

Siège et dossier rembourrés

Colors shown/ Couleurs montrées :
Magnetite (24)/ Fossil (JO)



in/po	W/L	D/P	H	S
26	19	22	37 1/4	26 1/4
30	19	22	41 1/4	30 1/4

Noah 41230

Urban

SWIVEL STOOL
(without memory return)
Solid wood base (birch) with upholstered seat and backrest

TABOURET PIVOTANT
(sans mécanisme à mémoire)
Base en bois massif (merisier) avec siège et dossier rembourrés

Colors shown / Couleurs montrées :
Earl grey (48) / Cloud (HF)



Wood colors available / Couleurs de bois disponibles

47 48 96

in/po	W/L	D/P	H	S
26	18 1/2	22	44	26 5/8
30	18 1/2	22	48	30 5/8

Nox 42534

Nordic

SWIVEL STOOL
(without memory return)
Upholstered seat

TABOURET PIVOTANT
(sans mécanisme à mémoire)
Siège rembourré

Colors shown / Couleurs montrées :
Magnetite (24) / Complicity (KK)



in/po	W/L	D/P	H	S
26	18 1/4	18 1/4	27	27
30	19 3/4	19 3/4	31	31

Opus 30132

Boudoir

CHAIR
Upholstered seat and backrest

CHAISE
Siège et dossier rembourrés

Colors shown / Couleurs montrées :
Metallo (57) / Flame (HB)



in/po	W/L	D/P	H	S
21	21 1/4	33 1/4	18 1/2	

Opus 40132

Boudoir

NON SWIVEL STOOL
Upholstered seat and backrest

TABOURET NON PIVOTANT
Siège et dossier rembourrés

Colors shown / Couleurs montrées :
Metallo (57) / Flame (HB)



in/po	W/L	D/P	H	S
26	21	23 7/8	40	26 1/8
30	21	23 7/8	44	30 1/8

Osten 30331

Urban

CHAIR

Upholstered seat and backrest

CHAISE

Siège et dossier rembourrés

Colors shown / Couleurs montrées :
Metallo (57) / Darkness (EU)



in/po	W/L	D/P	H	S
	19	20 3/4	34 1/2	19 1/4

Osten 40329

Urban

NON SWIVEL STOOL

(low backrest)

Upholstered seat and backrest

TABOURET

NON PIVOTANT

(dossier bas)

Siège et dossier rembourrés

Colors shown / Couleurs montrées :
Metallo (57) / Limestone (EV)



in/po	W/L	D/P	H	S
26	19 3/4	20 1/2	35 3/4	26 3/4
30	20	20 1/2	39 3/4	30 3/4

Osten 40331

Urban

NON SWIVEL STOOL

Upholstered seat and backrest

TABOURET

NON PIVOTANT

Siège et dossier rembourrés

Colors shown / Couleurs montrées :
Metallo (57) / Limestone (EV)



in/po	W/L	D/P	H	S
26	19 3/4	21 5/8	42 3/4	26 3/4
30	20	21 5/8	46 3/4	30 3/4

Otis 40347

Urban

NEW

NON SWIVEL STOOL

Upholstered seat

NOUVEAU

TABOURET

NON PIVOTANT

Siège rembourré

Colors shown / Couleurs montrées :
Black coral / Noir corail (25) /
Alpaca (LC)



in/po	W/L	D/P	H	S
26	17 1/2	17 1/2	26 3/4	26 3/4
30	17 3/4	17 3/4	30 3/4	30 3/4

Outback 40336

Nordic

NON SWIVEL STOOL

Upholstered seat and backrest

TABOURET NON PIVOTANT

Siège et dossier rembourrés

Colors shown / Couleurs montrées :
Mineral (73) / Complicity (KK)



in/po	W/L	D/P	H	S
26	18 3/4	21 1/2	37	26
30	18 3/4	21 1/2	41	30

Owen 30154

Urban

CHAIR

Upholstered seat and metal backrest

CHAISE

Siège rembourré et dossier en métal

Colors shown / Couleurs montrées :
Dayglam (53) / Tuxedo (JQ)



in/po	W/L	D/P	H	S
	18 1/4	20 3/4	39 3/8	18 1/4

Owen 30154B

Industrial

CHAIR

Solid wood (birch) seat and metal backrest

CHAISE

Siège en bois massif (merisier) et dossier en métal

Colors shown / Couleurs montrées :
Harley (51) / Shady (84)



Wood colors available / Couleurs de bois disponibles

Distressed solid wood / Bois massif usé

78	79	80	81	82	84	86	87	89	93	45
----	----	----	----	----	----	----	----	----	----	----

Non-distressed solid wood / Bois massif non usé

39	41	42	43	44	46	47	48	49	96	85
----	----	----	----	----	----	----	----	----	----	----

in/po	W/L	D/P	H	S
	18 1/4	20 3/4	39 3/8	17

Owen 41454

Urban

SWIVEL STOOL

(without memory return)
Upholstered seat and metal backrest

TABOURET PIVOTANT

(sans mécanisme à mémoire)
Siège rembourré et dossier en métal

Colors shown / Couleurs montrées :
Black coral / Noir corail (25) /
Oceanic (JM)



in/po	W/L	D/P	H	S
26	18 1/4	20	40 3/4	26 5/8
30	18 1/4	20	44 3/4	30 5/8
34	18 3/4	20 1/2	48 1/2	34 5/8

Oxford 41510

Countryside

SWIVEL STOOL
(with memory return)
Upholstered seat and backrest

TABOURET PIVOTANT
(avec mécanisme à mémoire)
Siège et dossier rembourrés

Colors shown/ Couleurs montrées :
Cobrizo (75)/Stratus (DD)



in/po	W/L	D/P	H	S
26	17 3/4	20 3/4	41 3/4	26 1/2
30	17 3/4	20 3/4	45 3/4	30 1/2
34	17 3/4	21 1/4	49 3/4	34 1/2

Pablo 35304

Boudoir

CHAIR
Upholstered seat and backrest

CHAISE
Siège et dossier rembourrés

Colors shown/ Couleurs montrées :
Oxidado (52)/Biscuit (HO)



in/po	W/L	D/P	H	S
	19 1/2	24	33 1/4	18 3/4

Pablo 45304

Boudoir

NON SWIVEL STOOL
Upholstered seat and backrest

**TABOURET
NON PIVOTANT**
Siège et dossier rembourrés

Colors shown/ Couleurs montrées :
Oxidado (57)/Parchment (GT)



in/po	W/L	D/P	H	S
26	17 1/2	22 3/4	41	26 1/4
30	17 1/2	22 3/4	45	30 1/4

Pablo Plus 45305

Urban

NON SWIVEL STOOL
Upholstered seat and backrest

**TABOURET
NON PIVOTANT**
Siège et dossier rembourrés

Colors shown/ Couleurs montrées :
Metallo (57)/Parchment (GT)



in/po	W/L	D/P	H	S
26	19 1/2	23 3/4	41	26 1/4
30	19 1/2	23 3/4	45	30 1/4

Payton 30103

Urban

CHAIR

Upholstered seat and backrest

CHAISE

Siège et dossier rembourrés

Colors shown/ *Couleurs montrées* :
Titanium (56)/Blizzard (DH)



in/po	W/L	D/P	H	S
	18 1/4	21 1/2	37 1/4	18 1/4

Payton 40103

Urban

NON SWIVEL STOOL

Upholstered seat and backrest

TABOURET

NON PIVOTANT

Siège et dossier rembourrés

Colors shown/ *Couleurs montrées* :
Titanium (56)/Blizzard (DH)



in/po	W/L	D/P	H	S
26	18 1/4	20 1/2	39 1/4	26 5/8
30	18 1/4	20 1/2	43 1/4	30 5/8

Pearl 42514

Boudoir

SWIVEL STOOL

(without memory return)

Upholstered seat

TABOURET PIVOTANT

(sans mécanisme à mémoire)

Siège rembourré

Colors shown/ *Couleurs montrées* :
Oxidado (52)/Coal (HC)



in/po	W/L	D/P	H	S
26	15 3/4	15 3/4	26	26
30	17	17	30	30

Pedro 35308

Boudoir

CHAIR

Upholstered seat and backrest

CHAISE

Siège et dossier rembourrés

Colors shown/ *Couleurs montrées* :
Titanium (56)/Gatsby (KV)



in/po	W/L	D/P	H	S
	17 1/2	22 1/2	33 1/2	18 3/4

Phoebe 30571

Urban

CHAIR

Upholstered seat and backrest

CHAISE

Siège et dossier rembourrés

Colors shown/ *Couleurs montrées* :
Magnetite (24)/Stellar (JR)



in/po	W/L	D/P	H	S
	18	21 1/2	33 3/4	18 3/4

Phoebe 41571

Urban

SWIVEL STOOL

(without memory return)

Upholstered seat and backrest

TABOURET PIVOTANT

(sans mécanisme à mémoire)

Siège et dossier rembourrés

Colors shown/ *Couleurs montrées* :
Magnetite (24)/Stellar (JR)



in/po	W/L	D/P	H	S
26	18	20 3/4	38 3/8	26 1/2
30	18	20 3/4	42 3/8	30 1/2

Positano 41569

Urban

SWIVEL STOOL

(with memory return)

Upholstered seat, backrest and armrests

TABOURET PIVOTANT

(avec mécanisme à mémoire)

Siège, dossier et appuis-bras rembourrés

Colors shown/ *Couleurs montrées* :
Magnetite (24)/Ink (DA)



in/po	W/L	D/P	H	S	A
26	25 3/4	22	39 1/8	26	34 5/8
30	25 3/4	22	43 1/8	30	38 5/8

Radcliff 41537

Boudoir

SWIVEL STOOL

(with memory return and decorative nails)

Upholstered seat and backrest

TABOURET PIVOTANT

(avec mécanisme à mémoire et clous décoratifs)

Siège et dossier rembourrés

Colors shown/ *Couleurs montrées* :
Oxidado (52)/Shiitake (HT)



in/po	W/L	D/P	H	S
26	23 1/2	21	36 1/4	27 1/2
30	23 1/2	21	40 1/4	31 1/2

Nails only available in Black (NG)

Clous uniquement disponibles en Noir (NG)

Radcliff 41557

Boudoir

SWIVEL STOOL
(with memory return)
Upholstered seat and backrest

TABOURET PIVOTANT
(avec mécanisme à mémoire)
Siège et dossier rembourrés

Colors shown / Couleurs montrées :
Oxidado (52)/Shiitake (HT)



in/po	W/L	D/P	H	S
26	23 1/2	21	36 1/4	27 1/2
30	23 1/2	21	40 1/4	31 1/2

Reel 42436

Urban

SWIVEL STOOL
(without memory return)
Upholstered seat

TABOURET PIVOTANT
(sans mécanisme à mémoire)
Siège rembourré

Colors shown / Couleurs montrées :
Metallo (57)/Flame (HB)



in/po	W/L	D/P	H	S
26	18	18	25 7/8	25 7/8
30	18	18	29 7/8	29 7/8
34	19 1/4	19 1/4	33 7/8	33 7/8

Ronny 41442

Urban

SWIVEL STOOL
(without memory return)
Upholstered seat and backrest

TABOURET PIVOTANT
(sans mécanisme à mémoire)
Siège et dossier rembourrés

Colors shown / Couleurs montrées :
Titanium (56)/Oyster (DB)



in/po	W/L	D/P	H	S
26	20 3/4	19 1/4	36	26 3/4
30	20 3/4	19 1/4	40	30 3/4
34	20 3/4	19 1/4	44	34 3/4

Rudy 42442

Urban

SWIVEL STOOL
(without memory return)
Upholstered seat

TABOURET PIVOTANT
(sans mécanisme à mémoire)
Siège rembourré

Colors shown / Couleurs montrées :
Sun gold (27)/Marshmallow (DX)



in/po	W/L	D/P	H	S
26	17 3/4	17 3/4	26 3/4	26 3/4
30	17 3/4	17 3/4	30 3/4	30 3/4
34	17 3/4	17 3/4	34 3/4	34 3/4

Russell 41526

Industrial

SWIVEL STOOL
(without memory return)
Upholstered seat and backrest
with metal accent at the back

TABOURET PIVOTANT
(sans mécanisme à mémoire)
Siège et dossier rembourrés
avec accent de métal au dos

Colors shown / Couleurs montrées :
Oxidado (52) / Oyster (DB)



in/po	W/L	D/P	H	S
26	22 1/4	20 3/8	34 3/4	26 3/4
30	22 1/4	20 3/8	38 3/4	30 3/4
34	22 1/4	20 3/8	42 3/4	34 3/4

Scarlett 30344

Boudoir

NEW CHAIR
Upholstered seat and backrest

NOUVEAU CHAISE
Siège et dossier rembourrés

Colors shown / Couleurs montrées :
Dayglam (53) / Cerulean (JK)



in/po	W/L	D/P	H	S
	22 1/4	23 1/4	32	18 3/4

Scarlett 41344

Boudoir

NEW SWIVEL STOOL
(without memory return)
Upholstered seat and backrest

NOUVEAU TABOURET PIVOTANT
(sans mécanisme à mémoire)
Siège et dossier rembourrés

Colors shown / Couleurs montrées :
Dayglam (53) / Cerulean (JK)



in/po	W/L	D/P	H	S
26	22 1/4	23 1/4	40	23 3/4
30	22 1/4	23 1/2	44	30 3/4

Skyla 42344

Urban

NEW SWIVEL STOOL
(without memory return)
Upholstered seat

NOUVEAU TABOURET PIVOTANT
(sans mécanisme à mémoire)
Siège rembourré

Colors shown / Couleurs montrées :
Black coral / Noir corail (25) /
Blizzard (DH)



in/po	W/L	D/P	H	S
26	18 1/2	18 1/2	26 1/2	26 1/2
30	18 1/2	18 1/2	30 1/2	30 1/2

Skyla 42344-B

Urban

NEW

SWIVEL STOOL

(without memory return)
Solid wood (birch) seat

NEW

TABOURET PIVOTANT

(sans mécanisme à mémoire)
Siège en bois massif (merisier)

Colors shown / Couleurs montrées :
Dayglam (53)/Mouse (49)



Wood colors available / Couleurs de bois disponibles

Distressed solid wood / Bois massif usé

78	79	80	81	82	84	86	87	89	93	45
----	----	----	----	----	----	----	----	----	----	----

Non-distressed solid wood / Bois massif non usé

39	41	42	43	44	46	47	48	49	96	85
----	----	----	----	----	----	----	----	----	----	----

in/po	W/L	D/P	H	S
26B	18 1/2	18 1/2	25 1/4	25 1/4
30B	18 1/2	18 1/2	29 1/4	29 1/4

Sonoma 40355

Urban

NON SWIVEL STOOL

Upholstered seat

TABOURET

NON PIVOTANT

Siège rembourré

Colors shown / Couleurs montrées :
Sun gold (27)/Blizzard (DH)



in/po	W/L	D/P	H	S
26	17 1/4	17 1/4	31 3/8	27
30	17 1/4	17 1/4	35 3/8	31

Sorrento 30539

Urban

SWIVEL CHAIR

(with memory return)
Upholstered seat, backrest and armrests

CHAISE PIVOTANTE

(avec mécanisme à mémoire)
Siège, dossier et appuis-bras rembourrés

Colors shown / Couleurs montrées :
Magnetite (24)/Flame (HB)



in/po	W/L	D/P	H	S	A
25 3/4	22	31 5/8	19 1/4	27 1/4	

Sorrento 41539

Urban

SWIVEL STOOL

(with memory return)
Upholstered seat, backrest and armrests

TABOURET PIVOTANT

(avec mécanisme à mémoire)
Siège, dossier et appuis-bras rembourrés

Colors shown / Couleurs montrées :
Magnetite (24)/Flame (HB)



in/po	W/L	D/P	H	S	A
26	25 3/4	22 1/2	40 5/8	27 1/2	36 1/4
30	25 3/4	22 1/2	44 5/8	31 1/2	40 1/4

Sunny 41575

Boudoir

NEW
SWIVEL STOOL
(with memory return)
Upholstered seat and backrest

NEW
TABOURET PIVOTANT
(avec mécanisme à mémoire)
Siège et dossier rembourrés

Colors shown / Couleurs montrées :
Titanium (56)/Celestial (L9)



in/po	W/L	D/P	H	S
26	21	24 1/4	46 1/4	27 3/4
30	21	24 1/4	50 1/4	31 3/4

Tori 30124

Urban

CHAIR
Upholstered seat and
metal backrest

CHAISE
Siège rembourré et dossier
en métal

Colors shown / Couleurs montrées :
Mineral (73)/Nova (E8)



in/po	W/L	D/P	H	S
	19 3/4	21 1/2	34	18 1/2

Tori 30124B

Industrial

CHAIR
Solid wood (birch) seat
and metal backrest

CHAISE
Siège en bois massif (merisier)
et dossier en métal

Colors shown / Couleurs montrées :
Harley (51)/Toasty (87)



Wood colors available / Couleurs de bois disponibles
Distressed solid wood / Bois massif usé

78	79	80	81	82	84	86	87	89	93	45
----	----	----	----	----	----	----	----	----	----	----

Non-distressed solid wood / Bois massif non usé

39	41	42	43	44	46	47	48	49	96	85
----	----	----	----	----	----	----	----	----	----	----

in/po	W/L	D/P	H	S
	19 3/4	21 5/8	34	17 1/4

Tori 30144

Urban

ARMCHAIR
Upholstered seat with
metal backrest and armrests

CHAISE AVEC BRAS
Siège rembourré avec dossier et
appuis-bras en métal

Colors shown / Couleurs montrées :
Magnetite (24)/Ink (DA)



in/po	W/L	D/P	H	S	A
	21 1/4	21 1/2	34	18 1/2	25 3/4

Tori 30144B

Industrial

ARMCHAIR

Solid wood (birch) seat with metal backrest and armrests

CHAISE AVEC BRAS

Siège en bois massif (merisier) avec dossier et appuis-bras en métal

Colors shown / Couleurs montrées : Harley (51) / Toasty (87)



Wood colors available / Couleurs de bois disponibles

Distressed solid wood / Bois massif usé

78	79	80	81	82	84	86	87	89	93	45
----	----	----	----	----	----	----	----	----	----	----

Non-distressed solid wood / Bois massif non usé

39	41	42	43	44	46	47	48	49	96	85
----	----	----	----	----	----	----	----	----	----	----

in/po	W/L	D/P	H	S	A
	21 1/4	21 5/8	34	17 1/4	25 3/4

Umbria 41581

Urban

SWIVEL STOOL

(without memory return)
Upholstered seat and backrest

TABOURET PIVOTANT

(sans mécanisme à mémoire)
Siège et dossier rembourrés

Colors shown / Couleurs montrées : Dayglam (53) / Sirius (L6)



in/po	W/L	D/P	H	S
26	18 1/2	20	37	27 3/4
30	18 1/2	20	41	31 3/4

Upright 40264

Industrial

NON SWIVEL STOOL

Upholstered seat and solid wood (birch) backrest

TABOURET NON PIVOTANT

Siège rembourré et dossier en bois massif (merisier)

Colors shown / Couleurs montrées : Oxidado (52) / Sleet (BA) / Toasty (87)



Wood colors available / Couleurs de bois disponibles

Distressed solid wood / Bois massif usé

78	79	80	81	82	84	86	87	89	93	45
----	----	----	----	----	----	----	----	----	----	----

Non-distressed solid wood / Bois massif non usé

39	41	42	43	44	46	47	48	49	96	85
----	----	----	----	----	----	----	----	----	----	----

in/po	W/L	D/P	H	S
26	16 1/2	20	38	26 7/8
30	17	20	42	30 7/8

Upright 40264-B

Industrial

NON SWIVEL STOOL

Solid wood (birch) seat and backrest

TABOURET NON PIVOTANT

Siège et dossier en bois massif (merisier)

Colors shown / Couleurs montrées : Oxidado (52) / Toasty (87)



Wood colors available / Couleurs de bois disponibles

Distressed solid wood / Bois massif usé

78	79	80	81	82	84	86	87	89	93	45
----	----	----	----	----	----	----	----	----	----	----

Non-distressed solid wood / Bois massif non usé

39	41	42	43	44	46	47	48	49	96	85
----	----	----	----	----	----	----	----	----	----	----

in/po	W/L	D/P	H	S
26B	16 1/2	20	38	26
30B	17	20	42	30

Upright 42564

Industrial

NON SWIVEL STOOL

Upholstered seat

TABOURET NON PIVOTANT

Siège rembourré

Colors shown / Couleurs montrées :
Oxidado (52) / Ginseng (JN)



in/po	W/L	D/P	H	S
26	16 1/2	16 1/2	26 7/8	26 7/8
30	17	17	30 7/8	30 7/8

Upright 42564-B

Industrial

NON SWIVEL STOOL

Solid wood (birch) seat

TABOURET NON PIVOTANT

Siège en bois massif (merisier)

Colors shown / Couleurs montrées :
Oxidado (52) / Toasty (87)



Wood colors available / Couleurs de bois disponibles

Distressed solid wood / Bois massif usé

78	79	80	81	82	84	86	87	89	93	45
----	----	----	----	----	----	----	----	----	----	----

Non-distressed solid wood / Bois massif non usé

39	41	42	43	44	46	47	48	49	96	85
----	----	----	----	----	----	----	----	----	----	----

in/po	W/L	D/P	H	S
26B	16 1/2	16 1/2	26	26
30B	17	17	30	30

Visconti 41253

Nordic

SWIVEL STOOL

(without memory return)
Upholstered seat and backrest
with solid wood legs (birch) and
metal footrest

TABOURET PIVOTANT

(sans mécanisme à mémoire)
Siège et dossier rembourrés
avec pattes en bois massif
(merisier) et appui-pied en
métal

Colors shown / Couleurs montrées :
Metallo (57) / Boardwalk (KX) /
Cashew (46)



Wood colors available / Couleurs de bois disponibles

Non-distressed solid wood / Bois massif non usé

39	43	46	47	96
----	----	----	----	----

in/po	W/L	D/P	H	S
26	19 1/4	22	37 1/4	26 1/4
30	19 1/4	22	41 1/4	30 1/4

Waverly 30353

Nordic

CHAIR

Upholstered seat and backrest

CHAISE

Siège et dossier rembourrés

Colors shown / Couleurs montrées :
Titanium (56) / River (HK)



in/po	W/L	D/P	H	S
	18 1/4	24	34	19

Waverly 40353

Nordic

NON SWIVEL STOOL

Upholstered seat and backrest

TABOURET NON PIVOTANT

Siège et dossier rembourrés

Colors shown/ Couleurs montrées :
Titanium (56)/Stratus (DD)



in/po	W/L	D/P	H	S
26	18 1/4	24 1/4	37 1/4	27 1/4
30	18 1/4	24 1/4	41 1/4	31 1/4

Wayne 41257

Boudoir

SWIVEL STOOL

(without memory return)

Solid wood base (birch) with upholstered seat and backrest

TABOURET PIVOTANT (sans mécanisme à mémoire)

Base en bois massif (merisier) avec siège et dossier rembourrés

Colors shown/ Couleurs montrées :
Earl grey (48)/Shiitake (HT)



Wood colors available/ Couleurs de bois disponibles

47 48 96

in/po	W/L	D/P	H	S
26	23 1/2	21	35 3/8	26 3/4
30	23 1/2	21	39 3/8	30 3/4

Webber 30330

Boudoir

CHAIR

Upholstered seat and backrest

CHAISE

Siège et dossier rembourrés

Colors shown/ Couleurs montrées :
Titanium (56)/Shiitake (HT)



in/po	W/L	D/P	H	S
18 1/2	21 1/4	35 1/2	18	

Webber 41330

Boudoir

SWIVEL STOOL

(with memory return)

Upholstered seat and backrest

TABOURET PIVOTANT (avec mécanisme à mémoire)

Siège et dossier rembourrés

Colors shown/ Couleurs montrées :
Titanium (56)/Shiitake (HT)



in/po	W/L	D/P	H	S
26	18 1/2	21 1/4	44 3/4	27 3/4
30	18 1/2	21 1/4	48 3/4	31 3/4

Wembley 41578

Boudoir

SWIVEL STOOL
(without memory return)
Upholstered seat and backrest

TABOURET PIVOTANT
(sans mécanisme à mémoire)
Siège et dossier rembourrés

Colors shown / Couleurs montrées :
Sun gold (27) / Pebble (CB)



in/po	W/L	D/P	H	S
26	21 3/4	22 1/4	37	26 1/2
30	21 3/4	22 1/4	41	30 1/2

Weston 30534

Boudoir

SWIVEL CHAIR
(with memory return)
Upholstered seat and backrest

CHAISE PIVOTANTE
(avec mécanisme à mémoire)
Siège et dossier rembourrés

Colors shown / Couleurs montrées :
Sun gold (27) / Parchment (GT)



in/po	W/L	D/P	H	S
	22	24	35	19 1/2

Weston 41534

Boudoir

SWIVEL STOOL
(with memory return)
Upholstered seat and backrest

TABOURET PIVOTANT
(avec mécanisme à mémoire)
Siège et dossier rembourrés

Colors shown / Couleurs montrées :
Titanium (56) / Parchment (GT)



in/po	W/L	D/P	H	S
26	22	24	43 1/4	27 3/4
30	22	24	47 1/4	31 3/4

Whisky 41512

Countryside

SWIVEL STOOL
(with memory return)
Upholstered seat and metal backrest with non-distressed solid wood (birch) accent

TABOURET PIVOTANT
(avec mécanisme à mémoire)
Siège rembourré et dossier en métal avec accent en bois massif non usé (merisier)

Colors shown / Couleurs montrées :
Mineral (73) / Pebble (CB) / Tiramisu (47)



Wood colors available / Couleurs de bois disponibles
Non-distressed solid wood / Bois massif non usé

39	41	42	43	44	46	47	48	49	96	85
----	----	----	----	----	----	----	----	----	----	----

in/po	W/L	D/P	H	S
26	16 3/4	20	37	26 1/4
30	16 3/4	20	41	30 1/4

Wilbur 30570

Nordic

CHAIR

Upholstered seat and backrest

CHAISE

Siège et dossier rembourrés

Colors shown / *Couleurs montrées* :
Oxidado (52) / Cactus (KE)



in/po	W/L	D/P	H	S
	19 1/4	21 1/2	32 1/4	19

Wilbur 41570

Nordic

SWIVEL STOOL

(without memory return)

Upholstered seat and backrest

TABOURET PIVOTANT

(sans mécanisme à mémoire)

Siège et dossier rembourrés

Colors shown / *Couleurs montrées* :
Oxidado (52) / Cactus (KE)



in/po	W/L	D/P	H	S
26	19 1/4	20	40 3/4	27 1/4
30	19 1/4	20	44 3/4	31 1/4

Zahra 30334

Nordic

CHAIR

Upholstered seat and backrest

CHAISE

Siège et dossier rembourrés

Colors shown / *Couleurs montrées* :
Black coral / *Noir corail* (25) /
Pixel (BP)



in/po	W/L	D/P	H	S
	21 1/2	23	35 1/4	19 3/4

Zahra 41334

Nordic

SWIVEL STOOL

(without memory return)

Upholstered seat and backrest

TABOURET PIVOTANT

(sans mécanisme à mémoire)

Siège et dossier rembourrés

Colors shown / *Couleurs montrées* :
Black coral / *Noir corail* (25) /
Pixel (BP)



in/po	W/L	D/P	H	S
26	21 1/2	23	42 1/4	26 1/2
30	21 1/2	23	46 1/4	30 1/2

Zao 41219

Nordic

SWIVEL STOOL

(without memory return)
Upholstered seat and wood veneer backrest (birch) with solid wood legs (birch) and metal footrest

TABOURET PIVOTANT

(sans mécanisme à mémoire)
Siège rembourré et dossier en placage de bois (merisier) avec pattes en bois massif (merisier) et appui-pied en métal

Colors shown/ Couleurs montrées :
Black coral/ Noir corail (25)/
Interlink (JP)/Pine cone (96)



Wood colors available/ Couleurs de bois disponibles

Non-distressed solid wood/Bois massif non usé

39 43 46 47 96

in/po	W/L	D/P	H	S
26	20 3/4	19 3/4	36 1/4	26 1/4 33 3/4
30	20 3/4	20 1/4	40 1/4	30 1/4 37 3/4

Zip 42334

Urban

SWIVEL STOOL

(without memory return)
Upholstered seat

TABOURET PIVOTANT

(sans mécanisme à mémoire)
Siège rembourré

Colors shown/ Couleurs montrées :
Metallo (57)/Dolphin (GS)



in/po	W/L	D/P	H	S
26	17	17	26 1/2	26 1/2
30	17	17	30 1/2	30 1/2

Zola 30342

Urban

NEW CHAIR

Upholstered seat and backrest

NOUVEAU CHAISE

Siège et dossier rembourrés

Colors shown/ Couleurs montrées :
Black coral/ Noir corail (25)/
Cloud (HF)



in/po	W/L	D/P	H	S
18 1/2	22 1/2	35 1/4	19 5/8	

Zola 40342

Urban

NEW SWIVEL STOOL

(without memory return)
Upholstered seat and backrest

NOUVEAU TABOURET PIVOTANT

(sans mécanisme à mémoire)
Siège et dossier rembourrés

Colors shown/ Couleurs montrées :
Cobrizo (75)/Shiitake (HT)



in/po	W/L	D/P	H	S
26	19 1/2	22	39 1/4	27 5/8
30	29 3/4	22 1/4	43 1/4	31 5/8

Benches

Bancs

Π



Architect 30272

Industrial

BENCH

(short version)

Upholstered seat and solid wood (birch) backrest

BANC

(version courte)

Siège rembourré et dossier en bois massif (merisier)

Wood colors available / Couleurs de bois disponibles

Distressed solid wood / Bois massif usé

78	79	80	81	82	84	86	87	89	93
----	----	----	----	----	----	----	----	----	----

Non-distressed solid wood / Bois massif non usé

39	41	42	43	44	46	47	48	49	96
----	----	----	----	----	----	----	----	----	----

in/po	W/L	D/P	H	S
	44	20	32 1/4	19

Colors shown / Couleurs montrées : Oxidado (52)/Roasted (HV)/Milk (80)



Architect 30272B

Industrial

BENCH

(short version)

Solid wood (birch) seat and backrest

BANC

(version courte)

Siège et dossier en bois massif (merisier)

Wood colors available / Couleurs de bois disponibles

Distressed solid wood / Bois massif usé

78	79	80	81	82	84	86	87	89	93
----	----	----	----	----	----	----	----	----	----

Non-distressed solid wood / Bois massif non usé

39	41	42	43	44	46	47	48	49	96
----	----	----	----	----	----	----	----	----	----

in/po	W/L	D/P	H	S
	44	20	32 1/4	17 3/4

Colors shown / Couleurs montrées : Oxidado (52)/Milk (80)



Architect 30273

Industrial

BENCH

(long version)

Upholstered seat and solid wood (birch) backrest

BANC

(version longue)

Siège rembourré et dossier en bois massif (merisier)

Wood colors available / Couleurs de bois disponibles

Distressed solid wood / Bois massif usé

78	79	80	81	82	84	86	87	89	93
----	----	----	----	----	----	----	----	----	----

Non-distressed solid wood / Bois massif non usé

39	41	42	43	44	46	47	48	49	96
----	----	----	----	----	----	----	----	----	----

in/po	W/L	D/P	H	S
	60	20	32 1/4	19

Colors shown / Couleurs montrées : Oxidado (52)/Roasted (HV)/Milk (80)



Architect 30273B

Industrial

BENCH

(long version)

Solid wood (birch) seat and backrest

BANC

(version longue)

Siège et dossier en bois massif (merisier)

Wood colors available / Couleurs de bois disponibles

Distressed solid wood / Bois massif usé

78	79	80	81	82	84	86	87	89	93
----	----	----	----	----	----	----	----	----	----

Non-distressed solid wood / Bois massif non usé

39	41	42	43	44	46	47	48	49	96
----	----	----	----	----	----	----	----	----	----

in/po	W/L	D/P	H	S
	60	20	32 1/4	17 3/4

Colors shown / Couleurs montrées : Oxidado (52)/Milk (80)



Benson 30444

Nordic

BENCH

(short version)

Upholstered seat

BANC

(version courte)

Siège rembourré

in/po	W/L	D/P	H	S
	44	15	19 1/2	19 1/2

Colors shown / Couleurs montrées : Sun gold (27) / Stellar (JR)



Benson 30444B

Nordic

BENCH

Solid wood (birch) seat

BANC

Siège en bois massif (merisier)

Wood colors available / Couleurs de bois disponibles

Distressed solid wood / Bois massif usé

78	79	80	81	82	84	86	87	89	93
----	----	----	----	----	----	----	----	----	----

Non-distressed solid wood / Bois massif non usé

39	41	42	43	44	46	47	48	49	96
----	----	----	----	----	----	----	----	----	----

in/po	W/L	D/P	H	S
	44	15	18 1/4	18 1/4

Colors shown / Couleurs montrées : Sun gold (27) / Cashew (46)



Benson 30446

Nordic

BENCH

(long version)

Upholstered seat

BANC

(version longue)

Siège rembourré

in/po	W/L	D/P	H	S
	60	15	19 1/2	19 1/2

Colors shown / Couleurs montrées : Sun gold (27) / Stellar (JR)



Benson 30446B

Nordic

BENCH

Solid wood (birch) seat

BANC

Siège en bois massif (merisier)

Wood colors available / Couleurs de bois disponibles

Distressed solid wood / Bois massif usé

78	79	80	81	82	84	86	87	89	93
----	----	----	----	----	----	----	----	----	----

Non-distressed solid wood / Bois massif non usé

39	41	42	43	44	46	47	48	49	96
----	----	----	----	----	----	----	----	----	----

in/po	W/L	D/P	H	S
	60	15	18 1/4	18 1/4

Colors shown / Couleurs montrées : Sun gold (27) / Cashew (46)



Dryden 30409

Industrial

BENCH

(short version)

Upholstered seat

BANC

(version courte)

Siège rembourré

in/po	W/L	D/P	H	S
	44	15	19	19

Colors shown / Couleurs montrées : Magnetite (24)/Pixel (BP)



Dryden 30409B

Industrial

BENCH

(short version)

Solid wood (birch) seat

BANC

(version courte)

Siège en bois massif (merisier)

Wood colors available / Couleurs de bois disponibles
Distressed solid wood / Bois massif usé

78	79	80	81	82	84	86	87	89	93
----	----	----	----	----	----	----	----	----	----

Non-distressed solid wood / Bois massif non usé

39	41	42	43	44	46	47	48	49	96
----	----	----	----	----	----	----	----	----	----

in/po	W/L	D/P	H	S
	44	15	17 1/2	17 1/2

Colors shown / Couleurs montrées : Magnetite (24)/Stone dust (89)



Dryden 30419

Industrial

BENCH

(long version)

Upholstered seat

BANC

(version longue)

Siège rembourré

in/po	W/L	D/P	H	S
	60	15	19	19

Colors shown / Couleurs montrées : Magnetite (24)/Pixel (BP)



Dryden 30419B

Industrial

BENCH

(long version)

Solid wood (birch) seat

BANC

(version longue)

Siège en bois massif (merisier)

Wood colors available / Couleurs de bois disponibles
Distressed solid wood / Bois massif usé

78	79	80	81	82	84	86	87	89	93
----	----	----	----	----	----	----	----	----	----

Non-distressed solid wood / Bois massif non usé

39	41	42	43	44	46	47	48	49	96
----	----	----	----	----	----	----	----	----	----

in/po	W/L	D/P	H	S
	60	15	17 1/2	17 1/2

Colors shown / Couleurs montrées : Magnetite (24)/Stone dust (89)



Monroe 30474

Urban

BENCH

(short version)

Upholstered seat and backrest

BANC

(version courte)

Siège et dossier rembourrés

in/po	W/L	D/P	H	S
	48	24	33 1/4	18 1/2

Colors shown/ Couleurs montrées : Titanium (56)/Slate (HD)



Monroe 30478

Urban

BENCH

(long version)

Upholstered seat and backrest

BANC

(version longue)

Siège et dossier rembourrés

in/po	W/L	D/P	H	S
	72	24	33 1/4	18 1/2

Colors shown/ Couleurs montrées : Titanium (56)/Slate (HD)



Pablo 30472

Urban

BENCH

(short version)

Upholstered seat and backrest

BANC

(version courte)

Siège et dossier rembourrés

in/po	W/L	D/P	H	S
	48	24	33 1/4	18 1/2

Colors shown/ Couleurs montrées : Oxidado (52)/Oyster (DB)



Pablo 30473

Urban

BENCH

(long version)

Upholstered seat and backrest

BANC

(version longue)

Siège et dossier rembourrés

in/po	W/L	D/P	H	S
	72	24	33 1/4	18 1/2

Colors shown/ Couleurs montrées : Oxidado (52)/Oyster (DB)



Upright 30408

Industrial

BENCH

(short version)

Upholstered seat

BANC

(version courte)

Siège rembourré

in/po	W/L	D/P	H	S
	44	15	18 3/4	18 3/4

Colors shown / Couleurs montrées : Black coral / Noir corail (25) / Elephant (DN)



Upright 30408B

Industrial

BENCH

(short version)

Solid wood (birch) seat

BANC

(version courte)

Siège en bois massif (merisier)

Wood colors available / Couleurs de bois disponibles
Distressed solid wood / Bois massif usé

78	79	80	81	82	84	86	87	89	93
----	----	----	----	----	----	----	----	----	----

Non-distressed solid wood / Bois massif non usé

39	41	42	43	44	46	47	48	49	96
----	----	----	----	----	----	----	----	----	----

in/po	W/L	D/P	H	S
	44	15	17 1/2	17 1/2

Colors shown / Couleurs montrées : Black coral / Noir corail (25) / Stone dust (89)



Upright 30410

Industrial

BENCH

(long version)

Upholstered seat

BANC

(version longue)

Siège rembourré

in/po	W/L	D/P	H	S
	60	15	18 3/4	18 3/4

Colors shown / Couleurs montrées : Black coral / Noir corail (25) / Elephant (DN)



Upright 30410B

Industrial

BENCH

(long version)

Solid wood (birch) seat

BANC

(version longue)

Siège en bois massif (merisier)

Wood colors available / Couleurs de bois disponibles
Distressed solid wood / Bois massif usé

78	79	80	81	82	84	86	87	89	93
----	----	----	----	----	----	----	----	----	----

Non-distressed solid wood / Bois massif non usé

39	41	42	43	44	46	47	48	49	96
----	----	----	----	----	----	----	----	----	----

in/po	W/L	D/P	H	S
	60	15	17 1/2	17 1/2

Colors shown / Couleurs montrées : Black coral / Noir corail (25) / Stone dust (89)

Accent Furniture
Meuble d'accent



Munich 30425

Urban

ARMCHAIR

Upholstered seat and backrest
with metal armrests

FAUTEUIL

Siège et dossier rembourrés
avec appuis-bras en métal

in/po	W/L	D/P	H	S	A
	30 7/8	28 1/2	30	16 1/2	25

Colors shown / Couleurs montrées : Cobrizo (75) / Pebble (CB)

Living Room Islands

Îlots de salon

A fun and innovative way to gather in the living room

Get ready for a true innovation designed for nowadays' lifestyle: the living room island!

It's not just a counter height desk, it's more than a dinner table: it's a flexible unit that allows you to maximize your family room space with extra seating - just by adding up a few stools. Installed right behind your sofa, facing the TV, the living room island is the perfect spot to eat comfortably and relax. It can easily become a festive gathering point to watch the big game, or even turn into a home office! The living room island is available in a contemporary or industrial version, with its own collection of console, coffee and end tables. So practical, you'll wonder how your family managed without it!

Une façon innovante et amusante de se rassembler au salon

Un meuble innovant adapté au style de vie d'aujourd'hui fait son entrée dans votre maison: l'îlot de salon!

Ce n'est pas qu'un bureau haut, c'est plus qu'une table de cuisine: c'est une unité adaptative qui permet de maximiser la place assise au salon - simplement en ajoutant quelques tabourets. Installé derrière le sofa, face à la télé, l'îlot de salon est l'endroit parfait pour manger confortablement et relaxer. Il peut facilement prendre l'allure d'un bureau de travail à la maison, ou devenir le point de rassemblement festif lors d'évènements sportifs! L'îlot de salon est disponible en version contemporaine ou industrielle, et chaque design est accompagné de sa propre collection de tables d'accent: table de bout, à café, et console. Si pratique que vous vous demanderez comment votre famille a pu s'en passer si longtemps!



Urban



Industrial

Adjustable shelf

The adjustable shelf of the living room island can be installed at 4 different positions to fit the backrest height of your sofa.

Tablette ajustable

La tablette ajustable de l'îlot de salon peut être installée à 4 positions différentes selon la hauteur du dossier de votre sofa.

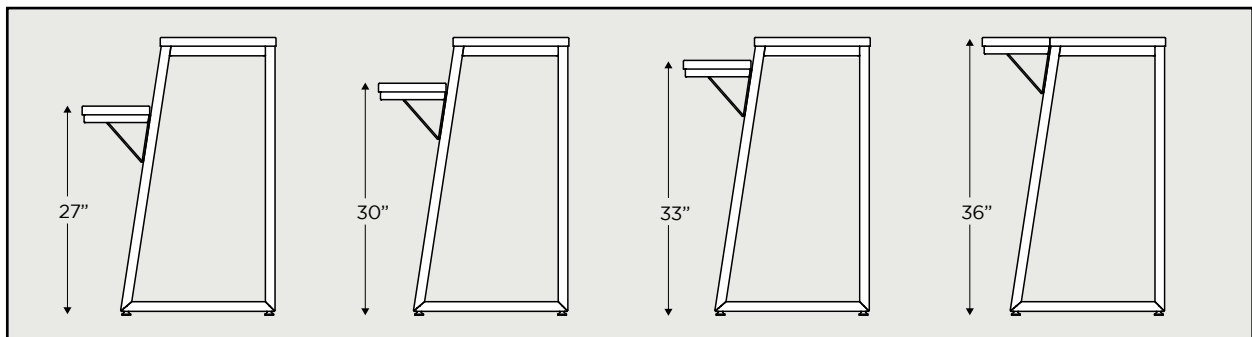

Living Room Table Program *Programme de tables de salon*



Wood Colors Available *Couleurs de bois disponibles*

Distressed solid wood (birch)
Bois massif usé (merisier)

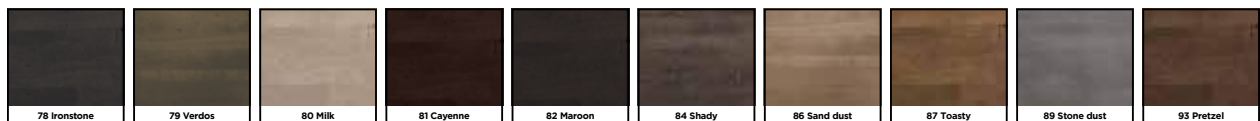

Non-distressed solid wood (birch)
Bois massif non usé (merisier)

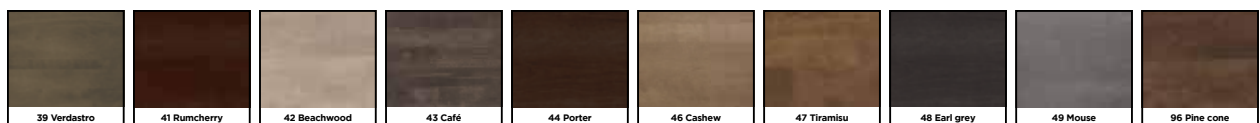

Thermo fused laminate (TFL)
Panneau laminé (TFL)

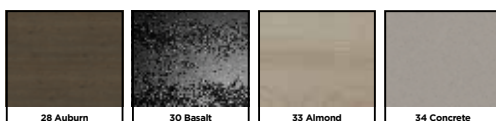

Wood veneer (walnut)
Placage de bois (noyer)

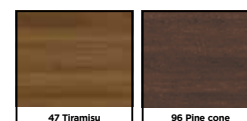

Wood veneer (birch)
Placage de bois (merisier)

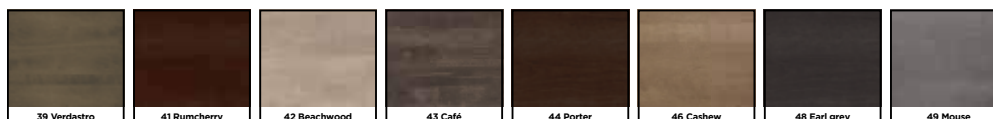



Crawford 50464



Urban

**LIVING ROOM ISLAND
BASE**
(short version)

BASE D'ÎLOT DE SALON
(version courte)

in/po	W/L	D/P	H
Overall / Hors-tout	53 3/4	24 3/4	34 7/8

Shown with 90494 tabletop / Montrée avec le dessus de table 90494
Colors shown / Couleurs montrées : Magnetite (24) / Stone dust (89)

COMPATIBLE TABLETOPS DESSUS DE TABLE COMPATIBLES		Thickness Épaisseur in/po	54 x 15  54 x 8 3/4 
Solid wood (birch) Bois massif (merisier)	Distressed / Usé 78 79 80 81 82 84 86 87 89 93	1 1/16	90494
	Non-distressed / Non usé 39 41 42 43 44 46 47 48 49 96		
Wood veneer (birch) Placage de bois (merisier)	39 41 42 43 44 46 48 49	1	90884
Wood veneer (walnut) Placage de bois (noyer)	47 96	1	90874
Thermo fused laminate (TFL) Panneau laminé	28 30 33 34	1	90584



Crawford 50764



Urban

**LIVING ROOM ISLAND
BASE**
(long version)

BASE D'ÎLOT DE SALON
(version longue)

in/po	W/L	D/P	H
Overall / Hors-tout	71 3/4	24 3/4	34 7/8

Shown with 90887 tabletop / Montrée avec le dessus de table 90887
Colors shown / Couleurs montrées : Magnetite (24) / Earl grey (48)

COMPATIBLE TABLETOPS DESSUS DE TABLE COMPATIBLES		Thickness Épaisseur in/po	72 x 15  72 x 8 3/4 
Solid wood (birch) Bois massif (merisier)	Distressed / Usé 78 79 80 81 82 84 86 87 89 93	1 1/16	90497
	Non-distressed / Non usé 39 41 42 43 44 46 47 48 49 96		
Wood veneer (birch) Placage de bois (merisier)	39 41 42 43 44 46 48 49	1	90887
Wood veneer (walnut) Placage de bois (noyer)	47 96	1	90877
Thermo fused laminate (TFL) Panneau laminé	28 30 33 34	1	90587



Crawford 50164

Urban

CONSOLE TABLE BASE BASE DE TABLE CONSOLE

in/po	W/L	D/P	H
Overall/Hors-tout	53 3/4	14 3/4	28 7/8

Shown with 90881 tabletop / Montrée avec le dessus de table 90881

Colors shown / Couleurs montrées : Magnetite (24) / Earl grey (48)

COMPATIBLE TABLETOPS DESSUS DE TABLE COMPATIBLES		Thickness Épaisseur in/po	54 x 15
Solid wood (birch) Bois massif (merisier)	Distressed/Usé 78 79 80 81 82 84 86 87 89 93	1 1/16	90491
	Non-distressed/Non usé 39 41 42 43 44 46 47 48 49 96		
Wood veneer (birch) Placage de bois (merisier)	39 41 42 43 44 46 48 49	1	90881
Wood veneer (walnut) Placage de bois (noyer)	47 96	1	90871
Thermo fused laminate (TFL) Panneau laminé	28 30 33 34	1	90581



Crawford 50264

Urban

END TABLE BASE BASE DE TABLE DE BOUT

in/po	W/L	D/P	H
Overall/Hors-tout	19 3/4	19 3/4	20 7/8

Shown with 90882 tabletop / Montrée avec le dessus de table 90882

Colors shown / Couleurs montrées : Magnetite (24) / Earl grey (48)

COMPATIBLE TABLETOPS DESSUS DE TABLE COMPATIBLES		Thickness Épaisseur in/po	20 x 20
Solid wood (birch) Bois massif (merisier)	Distressed/Usé 78 79 80 81 82 84 86 87 89 93	1 1/16	90492
	Non-distressed/Non usé 39 41 42 43 44 46 47 48 49 96		
Wood veneer (birch) Placage de bois (merisier)	39 41 42 43 44 46 48 49	1	90882
Wood veneer (walnut) Placage de bois (noyer)	47 96	1	90872
Thermo fused laminate (TFL) Panneau laminé	28 30 33 34	1	90582



Crawford 50364

Urban

COFFEE TABLE BASE

BASE DE TABLE À CAFÉ

in/po	W/L	D/P	H
Overall/Hors-tout	47 3/4	23 1/2	16 7/8

Shown with 90883 tabletop / Montrée avec le dessus de table 90883

Colors shown / Couleurs montrées : Magnetite (24) / Earl grey (48)

COMPATIBLE TABLETOPS DESSUS DE TABLE COMPATIBLES		Thickness Épaisseur in/po	48 x 23 3/4
Solid wood (birch) Bois massif (merisier)	Distressed / Usé 78 79 80 81 82 84 86 87 89 93	1 1/16	90493
	Non-distressed / Non usé 39 41 42 43 44 46 47 48 49 96		
Wood veneer (birch) Placage de bois (merisier)	39 41 42 43 44 46 48 49	1	90883
Wood veneer (walnut) Placage de bois (noyer)	47 96	1	90873
Thermo fused laminate (TFL) Panneau laminé	28 30 33 34	1	90583



Elwood 50465

Industrial

LIVING ROOM ISLAND BASE

(short version)

BASE D'ÎLOT DE SALON (version courte)

in/po	W/L	D/P	H
Overall/Hors-tout	53 3/4	24	34 7/8

Shown with 90494 tabletop / Montrée avec le dessus de table 90494

Colors shown / Couleurs montrées : Harley (51) / Toasty (87)

COMPATIBLE TABLETOPS DESSUS DE TABLE COMPATIBLES		Thickness Épaisseur in/po	54 x 15 54 x 8 3/4
Solid wood (birch) Bois massif (merisier)	Distressed / Usé 78 79 80 81 82 84 86 87 89 93	1 1/16	90494
	Non-distressed / Non usé 39 41 42 43 44 46 47 48 49 96		
Wood veneer (birch) Placage de bois (merisier)	39 41 42 43 44 46 48 49	1	90884
Wood veneer (walnut) Placage de bois (noyer)	47 96	1	90874
Thermo fused laminate (TFL) Panneau laminé	28 30 33 34	1	90584



Elwood 50765

Industrial

**LIVING ROOM ISLAND
BASE**



(long version)

BASE D'ÎLOT DE SALON
(version longue)

in/po	W/L	D/P	H
Overall / Hors-tout	71 3/4	24	34 7/8

Shown with 90497 tabletop / Montrée avec le dessus de table 90497

Colors shown / Couleurs montrées : Harley (51)/Toasty (87)

COMPATIBLE TABLETOPS DESSUS DE TABLE COMPATIBLES		Thickness Épaisseur in/po	72 x 15  72 x 8 3/4 
Solid wood (birch) Bois massif (merisier)	Distressed / Usé 78 79 80 81 82 84 86 87 89 93	1 1/16	90497
	Non-distressed / Non usé 39 41 42 43 44 46 47 48 49 96		
Wood veneer (birch) Placage de bois (merisier)	39 41 42 43 44 46 48 49	1	90887
Wood veneer (walnut) Placage de bois (noyer)	47 96	1	90877
Thermo fused laminate (TFL) Panneau laminé	28 30 33 34	1	90587



Elwood 50165

Industrial

CONSOLE TABLE BASE

BASE DE TABLE CONSOLE

in/po	W/L	D/P	H
Overall / Hors-tout	53 3/4	14 3/4	28 7/8

Shown with 90491 tabletop / Montrée avec le dessus de table 90491

Colors shown / Couleurs montrées : Harley (51)/Toasty (87)

COMPATIBLE TABLETOPS DESSUS DE TABLE COMPATIBLES		Thickness Épaisseur in/po	54 x 15 
Solid wood (birch) Bois massif (merisier)	Distressed / Usé 78 79 80 81 82 84 86 87 89 93	1 1/16	90491
	Non-distressed / Non usé 39 41 42 43 44 46 47 48 49 96		
Wood veneer (birch) Placage de bois (merisier)	39 41 42 43 44 46 48 49	1	90881
Wood veneer (walnut) Placage de bois (noyer)	47 96	1	90871
Thermo fused laminate (TFL) Panneau laminé	28 30 33 34	1	90581



Elwood 50265

Industrial

END TABLE BASE

BASE DE TABLE DE BOUT

in/po	W/L	D/P	H
Overall/Hors-tout	19 3/4	19 3/4	20 7/8

Shown with 90492 tabletop / Montrée avec le dessus de table 90492

Colors shown / Couleurs montrées : Harley (51)/Toasty (87)

COMPATIBLE TABLETOPS DESSUS DE TABLE COMPATIBLES		Thickness Épaisseur in/po	20 x 20 
Solid wood (birch) Bois massif (merisier)	Distressed/Usé 78 79 80 81 82 84 86 87 89 93	1 1/16	90492
	Non-distressed/Non usé 39 41 42 43 44 46 47 48 49 96		
Wood veneer (birch) Placage de bois (merisier)	39 41 42 43 44 46 48 49	1	90882
Wood veneer (walnut) Placage de bois (noyer)	47 96	1	90872
Thermo fused laminate (TFL) Panneau laminé	28 30 33 34	1	90582



Elwood 50365

Industrial

COFFEE TABLE BASE

BASE DE TABLE À CAFÉ

in/po	W/L	D/P	H
Overall/Hors-tout	47 3/4	23 1/2	16 7/8

Shown with 90493 tabletop / Montrée avec le dessus de table 90493

Colors shown / Couleurs montrées : Harley (51)/Toasty (87)

COMPATIBLE TABLETOPS DESSUS DE TABLE COMPATIBLES		Thickness Épaisseur in/po	48 x 23 3/4 
Solid wood (birch) Bois massif (merisier)	Distressed/Usé 78 79 80 81 82 84 86 87 89 93	1 1/16	90493
	Non-distressed/Non usé 39 41 42 43 44 46 47 48 49 96		
Wood veneer (birch) Placage de bois (merisier)	39 41 42 43 44 46 48 49	1	90883
Wood veneer (walnut) Placage de bois (noyer)	47 96	1	90873
Thermo fused laminate (TFL) Panneau laminé	28 30 33 34	1	90583



Jill 50262





END TABLE BASE

**BASE DE TABLE
DE BOUT**

in/po	W/L	D/P	H
Overall/Hors-tout	15 5/8	15 5/8	20 1/2

Shown with 90245 tabletop / Montrée avec le dessus de table 90245

Color shown / Couleur montrée : Titanium (56)

COMPATIBLE TABLETOPS DESSUS DE TABLE COMPATIBLES		Thickness Épaisseur in/po	19 1/2 x 19 1/2 	20 x 20 	24 dia. 	30 dia. 
Solid wood (birch) <i>Bois massif (merisier)</i>	Distressed / Usé 78 79 80 81 82 84 86 87 89 93	1 1/16		90492	90404	
	Non-distressed / Non usé 39 41 42 43 44 46 47 48 49 96					
Solid wood (ash) <i>Bois massif (frêne)</i>	A1 A2 A3 A6 A7 A8 A9 AA AV	1 1/16		93492		
Wood veneer (birch) <i>Placage de bois (merisier)</i>	39 41 42 43 44 46 48 49	1		90882	90814	90810
Wood veneer (walnut) <i>Placage de bois (noyer)</i>	47 96	1		90872	90815	90811
Thermo fused laminate (TFL) <i>Panneau laminé</i>	28 30 33 34	1		90582	90524	90528
Clear glass <i>Verre clair</i>	Clear <i>Clair</i>	1/2	90245		90244	
Mat black glass <i>Verre noir mat</i>	Mat black <i>Noir mat</i>	1/2	90265		90264	
Ultra white glass <i>Verre ultra blanc</i>	Ultra white <i>Ultra blanc</i>	1/2	90285		90284	
Porcelain on glass <i>Porcelaine sur verre</i>	Black marble finish <i>Fini marbre noir</i>	1/2	91295		91294	
	Statuario marble finish <i>Fini marbre statuario</i>	1/2	90295		90294	
Starstone on glass <i>Starstone sur verre</i>	70 71	1/2	91285		91284	



Jill 50362

COFFEE TABLE BASE **BASE DE TABLE À CAFÉ**

in/po	W/L	D/P	H
Overall / Hors-tout	24 3/4	44 3/4	16 1/2

Shown with 90248 tabletop / Montrée avec le dessus de table 90248

Color shown / Couleur montrée : Titanium (56)

COMPATIBLE TABLETOPS DESSUS DE TABLE COMPATIBLES		Thickness Épaisseur in/po	28 x 48 
Solid wood (birch) Bois massif (merisier)	Distressed / Usé 78 79 80 81 82 84 86 87 89 93	1 1/16	90851
	Non-distressed / Non usé 39 41 42 43 44 46 47 48 49 96		
Solid wood (ash) Bois massif (frêne)	A1 A2 A3 A6 A7 A8 A9 AA AV	1 1/16	93428
Wood veneer (birch) Placage de bois (merisier)	39 41 42 43 44 46 48 49	1	90849
Wood veneer (walnut) Placage de bois (noyer)	47 96	1	90850
Thermo fused laminate (TFL) Panneau laminé	28 30 33 34	1	90549
Clear glass Verre clair	Clear Clair	1/2	90248
Mat black glass Verre noir mat	Mat black Noir mat	1/2	90268
Ultra white glass Verre ultra blanc	Ultra white Ultra blanc	1/2	90288
Porcelain on glass Porcelaine sur verre	Black marble finish Fini marbre noir	1/2	91298
	Statuario marble finish Fini marbre statuario	1/2	90298
Starstone on glass Starstone sur verre	70 71	1/2	91288





Jill 50462

COFFEE TABLE BASE **BASE DE TABLE À CAFÉ**

in/po	W/L	D/P	H
Overall / Hors-tout	30 3/4	32 3/4	16 1/2

Shown with 90236 tabletop / Montrée avec le dessus de table 90236

Color shown / Couleur montrée : Titanium (56)

COMPATIBLE TABLETOPS DESSUS DE TABLE COMPATIBLES		Thickness Épaisseur in/po	36 dia. 	39 dia. 
Solid wood (birch) <i>Bois massif (merisier)</i>	Distressed / Usé 78 79 80 81 82 84 86 87 89 93	1 1/16	90406	
	Non-distressed / Non usé 39 41 42 43 44 46 47 48 49 96			
Solid wood (ash) <i>Bois massif (frêne)</i>	A1 A2 A3 A6 A7 A8 A9 AA AV	1 1/16	93406	
Wood veneer (birch) <i>Placage de bois (merisier)</i>	39 41 42 43 44 46 48 49	1	90817	
Wood veneer (walnut) <i>Placage de bois (noyer)</i>	47 96	1	90818	
Thermo fused laminate (TFL) <i>Panneau laminé</i>	28 30 33 34	1		90539
Clear glass <i>Verre clair</i>	Clear <i>Clair</i>	1/2	90236	
Clear glass (beveled edge) <i>Verre clair (chant en biseau)</i>	Clear <i>Clair</i>	3/8	90376	
Mat black glass <i>Verre noir mat</i>	Mat black <i>Noir mat</i>	1/2	90266	
Ultra white glass <i>Verre ultra blanc</i>	Ultra white <i>Ultra blanc</i>	1/2	90286	
Porcelain on glass <i>Porcelaine sur verre</i>	Black marble finish <i>Fini marbre noir</i>	1/2		91292
	Statuario marble finish <i>Fini marbre statuario</i>	1/2		90292
Starstone on glass <i>Starstone sur verre</i>	70 71	1/2	91286	



Malloy 50266

END TABLE BASE

**BASE DE TABLE
DE BOUT**

in/po	W/L	D/P	H
Overall/Hors-tout	19 1/4	19 1/4	20 1/2

Shown with 90295 tabletop / Montrée avec le dessus de table 90295

Color shown / Couleur montrée : Metallo (57)

COMPATIBLE TABLETOPS DESSUS DE TABLE COMPATIBLES		Thickness Épaisseur in/po	19 1/2 x 19 1/2	20 x 20	24 dia.	30 dia.
Solid wood (birch) Bois massif (merisier)	Distressed / Usé	78 79 80 81 82 84 86 87 89 93	1 1/16	90492	90404	
	Non-distressed / Non usé	39 41 42 43 44 46 47 48 49 96				
Solid wood (ash) Bois massif (frêne)	A1 A2 A3 A6 A7 A8 A9 AA AV	1 1/16		93492		
Wood veneer (birch) Placage de bois (merisier)	39 41 42 43 44 46 48 49	1		90882	90814	90810
Wood veneer (walnut) Placage de bois (noyer)	47 96	1		90872	90815	90811
Thermo fused laminate (TFL) Panneau laminé	28 30 33 34	1		90582	90524	90528
Clear glass Verre clair	Clear Clair	1/2	90245		90244	
Mat black glass Verre noir mat	Mat black Noir mat	1/2	90265		90264	
Ultra white glass Verre ultra blanc	Ultra white Ultra blanc	1/2	90285		90284	
Porcelain on glass Porcelaine sur verre	Black marble finish Fini marbre noir	1/2	91295		91294	
	Statuario marble finish Fini marbre statuario	1/2	90295		90294	
Starstone on glass Starstone sur verre	70 71	1/2	91285		91284	



Malloy 50366

COFFEE TABLE BASE **BASE DE TABLE À CAFÉ**

in/po	W/L	D/P	H
Overall / Hors-tout	45 1/4	25 1/4	16 1/2

Shown with 90849 tabletop / Montrée avec le dessus de table 90849

Colors shown / Couleurs montrées : Metallo (57) / Mouse (49)

COMPATIBLE TABLETOPS DESSUS DE TABLE COMPATIBLES		Thickness Épaisseur in/po	28 x 48
Solid wood (birch) <i>Bois massif (merisier)</i>	Distressed / Usé 78 79 80 81 82 84 86 87 89 93	1 1/16	90851
	Non-distressed / Non usé 39 41 42 43 44 46 47 48 49 96		
Solid wood (ash) <i>Bois massif (frêne)</i>	A1 A2 A3 A6 A7 A8 A9 AA AV	1 1/16	93428
Wood veneer (birch) <i>Placage de bois (merisier)</i>	39 41 42 43 44 46 48 49	1	90849
Wood veneer (walnut) <i>Placage de bois (noyer)</i>	47 96	1	90850
Thermo fused laminate (TFL) <i>Panneau laminé</i>	28 30 33 34	1	90549
Clear glass <i>Verre clair</i>	Clear <i>Clair</i>	1/2	90248
Mat black glass <i>Verre noir mat</i>	Mat black <i>Noir mat</i>	1/2	90268
Ultra white glass <i>Verre ultra blanc</i>	Ultra white <i>Ultra blanc</i>	1/2	90288
Porcelain on glass <i>Porcelaine sur verre</i>	Black marble finish <i>Fini marbre noir</i>	1/2	91298
	Statuario marble finish <i>Fini marbre statuario</i>	1/2	90298
Starstone on glass <i>Starstone sur verre</i>	70 71	1/2	91288



Malloy 50466

COFFEE TABLE BASE **BASE DE TABLE À CAFÉ**

in/po	W/L	D/P	H
Overall / Hors-tout	25 1/4	25 1/4	16 1/2

Shown with 90292 tabletop / Montrée avec le dessus de table 90292

Color shown / Couleur montrée : Metallo (57)

COMPATIBLE TABLETOPS DESSUS DE TABLE COMPATIBLES		Thickness Épaisseur in/po	36 dia.	39 dia.
Solid wood (birch) <i>Bois massif (merisier)</i>	Distressed / Usé 78 79 80 81 82 84 86 87 89 93	1 1/16	90406	
	Non-distressed / Non usé 39 41 42 43 44 46 47 48 49 96			
Solid wood (ash) <i>Bois massif (frêne)</i>	A1 A2 A3 A6 A7 A8 A9 AA	1 1/16	93406	
Wood veneer (birch) <i>Placage de bois (merisier)</i>	39 41 42 43 44 46 48 49	1	90817	
Wood veneer (walnut) <i>Placage de bois (noyer)</i>	47 96	1	90818	
Thermo fused laminate (TFL) <i>Panneau laminé</i>	28 30 33 34	1		90539
Clear glass <i>Verre clair</i>	Clear <i>Clair</i>	1/2	90236	
Clear glass (beveled edge) <i>Verre clair (chant en biseau)</i>	Clear <i>Clair</i>	3/8	90376	
Mat black glass <i>Verre noir mat</i>	Mat black <i>Noir mat</i>	1/2	90266	
Ultra white glass <i>Verre ultra blanc</i>	Ultra white <i>Ultra blanc</i>	1/2	90286	
Porcelain on glass <i>Porcelaine sur verre</i>	Black marble finish <i>Fini marbre noir</i>	1/2		91292
	Statuario marble finish <i>Fini marbre statuario</i>	1/2		90292
Starstone on glass <i>Starstone sur verre</i>	70 71	1/2	91286	



Maya 50403

NEW
END TABLE BASE

NOUVEAU
BASE DE TABLE DE BOUT

in/po	W/L	D/P	H
Overall / Hors-tout	18 1/4	3 1/2	21

Shown with 90815 tabletop / Montrée avec le dessus de table 90815
Colors shown / Couleurs montrées : Black coral / Noir corail (25) / Pine cone (96)

COMPATIBLE TABLETOPS DESSUS DE TABLE COMPATIBLES								Thickness Épaisseur in/po	24 dia. 	
Wood veneer (birch) Placage de bois (merisier)	39	41	42	43	44	46	48	49	1	90814
Wood veneer (walnut) Placage de bois (noyer)	47	96							1	90815
Thermo fused laminate (TFL) Panneau laminé	28	30	33	34					1	90524



Maya 50404

NEW
COFFEE TABLE BASE

NOUVEAU
BASE DE TABLE À CAFÉ

in/po	W/L	D/P	H
Overall / Hors-tout	27	3 1/2	17

Shown with 90818 tabletop / Montrée avec le dessus de table 90818
Colors shown / Couleurs montrées : Black coral / Noir corail (25) / Pine cone (96)

COMPATIBLE TABLETOPS DESSUS DE TABLE COMPATIBLES								Thickness Épaisseur in/po	36 dia. 	
Wood veneer (birch) Placage de bois (merisier)	39	41	42	43	44	46	48	49	1	90817
Wood veneer (walnut) Placage de bois (noyer)	47	96							1	90818
Thermo fused laminate (TFL) Panneau laminé	28	30	33	34					1	90526



Maya 50406

NEW
COFFEE TABLE BASE

NOUVEAU
BASE DE TABLE À CAFÉ

in/po	W/L	D/P	H
Overall/Hors-tout	18 1/4	3 1/2	13

Shown with 90524 tabletop / Montrée avec le dessus de table 90524

Colors shown / Couleurs montrées : Black coral / Noir corail (25) / Basalt (30)

COMPATIBLE TABLETOPS DESSUS DE TABLE COMPATIBLES									Thickness Épaisseur in/po	24 dia. 
Wood veneer (birch) Placage de bois (merisier)	39	41	42	43	44	46	48	49	1	90814
Wood veneer (walnut) Placage de bois (noyer)	47	96							1	90815
Thermo fused laminate (TFL) Panneau laminé	28	30	33	34					1	90524

Also compatible with convertable tabletops
with upholstered ottoman
*Également compatible avec les dessus de table
réversible avec repose-pieds rembourré*



Zuma 50161-20

END TABLE BASE

**BASE DE TABLE
DE BOUT**

in/po	W/L	D/P	H
Overall/Hors-tout	20 3/4	23 3/4	19 1/4

Shown with 90832 tabletop / *Montrée avec le dessus de table 90832*

Colors shown/ *Couleurs montrées* : Black coral/ *Noir corail* (25)/ Pine cone (96)

Upholstered ottoman convertable
into tabletop when flipped
*Repose-pieds rembourré convertible
en dessus de table lorsqu'il est retourné*



Zuma 50161-14





COFFEE TABLE BASE

BASE DE TABLE À CAFÉ

in/po	W/L	D/P	H
Overall/Hors-tout	20 3/4	23 3/4	13 1/4

Shown with 90833 convertable tabletop with ottoman / *Montrée avec le
dessus de table réversible avec repose-pieds rembourré 90833*

Colors shown/ *Couleurs montrées* : Black coral/ *Noir corail* (25)/
Pine cone (96)/ Interlink (JP)

COMPATIBLE TABLETOPS DESSUS DE TABLE COMPATIBLES					Thickness Épaisseur in/po	Hexagone 20 3/4 x 24 	30 dia. 	36 dia. 	39 dia. 	42 dia. 
Solid wood (birch) <i>Bois massif (merisier)</i>	78	79	80	81	1 1/16		90403			
	84	86	87	89						
Thermo fused laminate (TFL) <i>Panneau laminé</i>	28	30	33	34	1	90530	90528		90539	
Thermo fused laminate (TFL) with ottoman <i>Panneau laminé avec repose-pieds</i>					4	* 90531				
Wood veneer (birch) <i>Placage de bois (merisier)</i>	39	41	42	43	1	90830	90810	90817		90823
	46	48	49							
Wood veneer (birch) with ottoman <i>Placage de bois (merisier) avec repose-pieds</i>					4	* 90831				
Wood veneer (walnut) <i>Placage de bois (noyer)</i>	47	96			1	90832	90811	90818		90824
Wood veneer (walnut) with ottoman <i>Placage de bois (noyer) avec repose-pieds</i>					4	* 90833				
Clear glass <i>Verre clair</i>	Clear <i>Clair</i>				1/2		90230	90236		90242
Clear glass (beveled edge) <i>Verre clair (chant en biseau)</i>	Clear <i>Clair</i>				1/2			90376		90375
Mat black glass <i>Verre noir mat</i>	Mat black <i>Noir mat</i>				1/2			90266		90262
Ultra white glass <i>Verre ultra blanc</i>	Ultra white <i>Ultra blanc</i>				1/2			90286		90282
Porcelain on glass <i>Porcelaine sur verre</i>	Black marble finish <i>Fini marbre noir</i>				1/2					91292
	Statuario marble finish <i>Fini marbre statuario</i>				1/2					90292
Starstone on glass <i>Starstone sur verre</i>	70	71			1/2			91286		91282

*Ottoman available in all coverings

Repose-pieds disponibles dans tous les recouvrements



Zuma 50461

C TABLE BASE

BASE DE TABLE EN C

in/po	W/L	D/P	H
Overall / Hors-tout	20 3/4	23 3/4	25 1/4

Shown with 90530 tabletop / Montrée avec le dessus de table 90530

Colors shown / Couleurs montrées : Black coral / Noir corail (25) / Basalt (30)

COMPATIBLE TABLETOPS DESSUS DE TABLE COMPATIBLES		Thickness Épaisseur in/po	Hexagone 20 3/4 x 24 
Thermo fused laminate (TFL) <i>Panneau laminé</i>	28 30 33 34	1	90530
Wood veneer (birch) <i>Placage de bois (merisier)</i>	39 41 42 43 44 46 48 49	1	90830
Wood veneer (walnut) <i>Placage de bois (noyer)</i>	47 96	1	90832

Table Bases Bases de table



Aden 50537-38

TABLE BASE (counter height)		BASE DE TABLE (hauteur comptoir)		
in/po	W/L	D/P	H	
Overall/Hors-tout	26	26	38	

Shown with 90039 tabletop / Montrée avec le dessus de table 90039
Color shown / Couleur montrée : Magnetite (24)

Aden 50537-42

TABLE BASE (bar height)		BASE DE TABLE (hauteur bar)		
in/po	W/L	D/P	H	
Overall/Hors-tout	26	26	42	

COMPATIBLE TABLETOPS DESSUS DE TABLE COMPATIBLES		Thickness Épaisseur in/po	23 7/8 x 23 7/8
Solid wood (birch) Bois massif (merisier)	Distressed / Usé 78 79 80 81 82 84 86 87 89 93	7/8	50838-BO
	Non-distressed / Non usé 39 41 42 43 44 46 47 48 49 96		
Mat black glass Verre noir mat	Mat black Noir mat	1/2	90037
Ultra white glass Verre ultra blanc	Ultra white Ultra blanc	1/2	90039
Wood veneer (birch) Placage de bois (merisier)	39 41 42 43 44 46 48 49	1	90834
Wood veneer (walnut) Placage de bois (noyer)	47 96	1	90835
Thermo fused laminate (TFL) Panneau laminé	28 30 33 34	1	90538



Alex 50685

TABLE BASE (table height)

BASE DE TABLE (hauteur table)

in/po	W/L	D/P	H
Overall/Hors-tout	21 3/8	35 1/2	28 1/2
Distance between legs at seat height Distance entre les pattes à la hauteur siège	—	31 3/8	18

Shown with 90410 tabletop/Montrée avec le dessus de table 90410
Colors shown/Couleurs montrées : Oxidado (52)/Toasty (87)



For optimal comfort, we recommend the use of this table with a maximum of 4 chairs (2 chairs on each long side of the table).
Pour un confort optimal, nous recommandons d'utiliser cette table avec un maximum de 4 chaises (2 sur chaque bord long de la table).

Alex 50685-36

PUB TABLE BASE (counter height)

BASE DE TABLE PUB (hauteur comptoir)

in/po	W/L	D/P	H
Overall/Hors-tout	21 3/8	35 1/2	35 3/8
Distance between legs at seat height Distance entre les pattes à la hauteur siège	—	31 3/8	26

Alex 50685-42

PUB TABLE BASE (bar height)

BASE DE TABLE PUB (hauteur bar)

in/po	W/L	D/P	H
Overall/Hors-tout	21 3/8	35 1/2	41 3/8
Distance between legs at seat height Distance entre les pattes à la hauteur siège	—	31 3/8	30

Shown with 90851 tabletop/Montrée avec le dessus de table 90851
Colors shown/Couleurs montrées : Oxidado (52)/Toasty (87)

COMPATIBLE TABLETOPS DESSUS DE TABLE COMPATIBLES		Thickness Épaisseur in/po	28 x 48	32 x 54	36 x 60
Solid wood (birch) Bois massif (merisier)	Distressed/Usé	78 79 80 81 82 84 86 87 89 93	1 1/16	90851	90405 90410 91462*
	Non-distressed/Non usé	39 41 42 43 44 46 47 48 49 96	1 1/2		91461
Solid wood (ash) Bois massif (frêne)		A1 A2 A3 A6 A7 A8 A9 AA AV	1 1/16	93428	93410 93460
Wood veneer (birch) Placage de bois (merisier)		39 41 42 43 44 46 48 49	1	90849	90845 90860
Wood veneer (walnut) Placage de bois (noyer)		47 96	1	90850	90846 90861
Thermo fused laminate (TFL) Panneau laminé		28 30 33 34	1	90549	90554 90536
			1 5/8		90562

*Thickness of 1 1/2 / Épaisseur de 1 1/2



Alexis 50683

TABLE BASE
(table height)

BASE DE TABLE
(hauteur table)

in/po	W/L	D/P	H
Overall/Hors-tout	21 3/8	4	28 1/2
Distance between legs at seat height Distance entre les pattes à la hauteur siège	—	31 3/8	18

Shown with 91461 tabletop / Montrée avec le dessus de table 91461
Colors shown / Couleurs montrées : Harley (51) / Sand dust (86)

COMPATIBLE TABLETOPS DESSUS DE TABLE COMPATIBLES		Thickness Épaisseur in/po	28 x 48	32 x 54	36 x 60
Solid wood (birch) Bois massif (merisier)	Distressed / Usé	78 79 80 81 82 84 86 87 89 93	1 1/16	90851	90405 90410 91462*
	Solid wood (birch) with decorative bolts Bois massif (merisier) avec vis décoratives	39 41 42 43 44 46 47 48 49 96	1 1/2		91461
Solid wood (ash) Bois massif (frêne)	A1 A2 A3 A6 A7 A8 A9 AA AV	1 1/16	93428		93410 93460
Wood veneer (birch) Placage de bois (merisier)	39 41 42 43 44 46 48 49	1	90849	90845	90860
Wood veneer (walnut) Placage de bois (noyer)	47 96	1	90850	90846	90861
Thermo fused laminate (TFL) Panneau laminé	28 30 33 34	1	90549	90554	90536
		15/8			90562

*Thickness of 1 1/2 / Épaisseur de 1 1/2

Alys 50570

SQUARE TABLE BASE **BASE DE TABLE CARRÉE**
 (table height) (hauteur table)

in/po	W/L	D/P	H
Overall/Hors-tout	30 1/2	30 1/2	29 1/2
Distance between legs at seat height Distance entre les pattes à la hauteur siège	22 3/8	22 3/8	18

Shown with 90242 tabletop / Montrée avec le dessus de table 90242
 Color shown / Couleur montrée : Magnetite (24)



COMPATIBLE TABLETOPS DESSUS DE TABLE COMPATIBLES		Thickness Épaisseur in/po	36 dia.	39 dia.	42 dia.	48 dia.	36 x 36
Solid wood (birch) Bois massif (merisier)	Distressed/ Usé	78 79 80 81 82 84 86 87 89 93	1 1/16	90406	90412		90408
	Non-distressed/ Non usé	39 41 42 43 44 46 47 48 49 96					
Solid wood (ash) Bois massif (frêne)	A1 A2 A3 A6 A7 A8 A9 AA AV	1 1/16			93412		93408
Wood veneer (birch) Placage de bois (merisier)	39 41 42 43 44 46 48 49	1	90817		90823	90857	90827
Wood veneer (walnut) Placage de bois (noyer)	47 96	1	90818		90824	90858	90828
Thermo fused laminate (TFL) Panneau laminé	28 30 33 34	1		90539		*90548	90527
Clear glass Verre clair	Clear Clair	1/2	90236		90242	90247	90246
Clear glass (beveled edge) Verre clair (chant biseau)	Clear Clair	3/8	90376		90375	90378	
Mat black glass Verre noir mat	Mat black Noir mat	1/2	90266		90262	90267	90269
Ultra white glass Verre ultra blanc	Ultra white Ultra blanc	1/2	90286		90282	90287	90289
Porcelain on glass Porcelaine sur verre	Black marble finish Fini marbre noir	1/2		91292			
	Statuario marble finish Fini marbre statuario	1/2		90292			
Starstone on glass Starstone sur verre	70 71	1/2	91286		91282	91287	

*Auburn (28) only/ seulement.



Alys 50580

RECTANGULAR TABLE BASE

(table height)

BASE DE TABLE RECTANGULAIRE

(hauteur Table)

in/po	W/L	D/P	H
Overall/Hors-tout	30 1/2	56	29 1/2
Distance between legs at seat height Distance entre les pattes à la hauteur siège	22 3/8	47 3/4	18

Shown with 90260 tabletop / Montrée avec le dessus de table 90260

Color shown / Couleur montrée : Magnetite (24)

COMPATIBLE TABLETOPS DESSUS DE TABLE COMPATIBLES		Thickness Épaisseur in/po	36 x 60	39 1/2 x 71 1/2																
Solid wood (birch) Bois massif (merisier)	Distressed / Usé	1 1/16	90410																	
	<table border="1"> <tr><td>78</td><td>79</td><td>80</td><td>81</td><td>82</td><td>84</td><td>86</td><td>87</td><td>89</td><td>93</td></tr> <tr><td>39</td><td>41</td><td>42</td><td>43</td><td>44</td><td>46</td><td>47</td><td>48</td><td>49</td><td>96</td></tr> </table>				78	79	80	81	82	84	86	87	89	93	39	41	42	43	44	46
78	79	80	81	82	84	86	87	89	93											
39	41	42	43	44	46	47	48	49	96											
Solid wood (ash) Bois massif (frêne)	Non-distressed / Non usé	1 1/16	93410																	
	<table border="1"> <tr><td>A1</td><td>A2</td><td>A3</td><td>A6</td><td>A7</td><td>A8</td><td>A9</td><td>AA</td><td>AV</td></tr> </table>				A1	A2	A3	A6	A7	A8	A9	AA	AV							
A1	A2	A3	A6	A7	A8	A9	AA	AV												
Wood veneer (birch) Placage de bois (merisier)	<table border="1"> <tr><td>39</td><td>41</td><td>42</td><td>43</td><td>44</td><td>46</td><td>48</td><td>49</td></tr> </table>	39	41	42	43	44	46	48	49	1	90860	90863								
39	41	42	43	44	46	48	49													
Wood veneer (walnut) Placage de bois (noyer)	<table border="1"> <tr><td>47</td><td>96</td></tr> </table>	47	96	1	90861	90865														
47	96																			
Thermo fused laminate (TFL) Panneau laminé	<table border="1"> <tr><td>28</td><td>30</td><td>33</td><td>34</td></tr> </table>	28	30	33	34	1	90536	90563												
		28	30	33	34															
15/8	90562																			
Clear glass Verre clair	Clear Clair	1/2	90260	90271																
Mat black glass Verre noir mat	Mat black Noir mat	1/2	90270	90261																
Ultra white glass Verre ultra blanc	Ultra white Ultra blanc	1/2	90280	90281																
Porcelain on glass Porcelaine sur verre	Black marble finish Fini marbre noir	1/2	91290	91291																
	Statuario marble finish Fini marbre statuario	1/2	90290	90291																
Starstone on glass Starstone sur verre	<table border="1"> <tr><td>70</td><td>71</td></tr> </table>	70	71	1/2	91280	91281														
70	71																			



Azilis 50665 FOR WOOD TABLETOP
POUR DESSUS EN BOIS

NEW
TABLE BASE
(table height)

NOUVEAU
BASE DE TABLE
(hauteur table)

in/po	W/L	D/P	H
Overall/Hors-tout	31 1/4	53 1/4	28 7/8
Distance between legs at seat height Distance entre les pattes à la hauteur siège	27 1/4	49 1/4	18

Shown with 90554 tabletop/ Montrée avec le dessus de table 90554
Colors shown/ Couleurs montrées : Black coral/ Noir corail (25)/ Basalt (30)

Azilis 50665-36 FOR WOOD TABLETOP
POUR DESSUS EN BOIS

NEW
PUB TABLE BASE
(counter height)

NOUVEAU
BASE DE TABLE PUB
(hauteur comptoir)

in/po	W/L	D/P	H
Overall/Hors-tout	31 1/4	53 1/4	34 7/8
Distance between legs at seat height Distance entre les pattes à la hauteur siège	27 1/4	49 1/4	26

Shown with 90554 tabletop/ Montrée avec le dessus de table 90554
Colors shown/ Couleurs montrées : Black coral/ Noir corail (25)/ Concrete (34)

Azilis 50665-42 FOR WOOD TABLETOP
POUR DESSUS EN BOIS

NEW
PUB TABLE BASE
(bar height)

NOUVEAU
BASE DE TABLE PUB
(hauteur bar)

in/po	W/L	D/P	H
Overall/Hors-tout	31 1/4	53 1/4	40 7/8
Distance between legs at seat height Distance entre les pattes à la hauteur siège	27 1/4	49 1/4	18

COMPATIBLE TABLETOPS DESSUS DE TABLE COMPATIBLES		Thickness Épaisseur in/po	32 x 54
Solid wood (birch) Bois massif (merisier)	Distressed/ Usé 78 79 80 81 82 84 86 87 89 93	1 1/16	90405
	Non-distressed/ Non usé 39 41 42 43 44 46 47 48 49 96		
Wood veneer (birch) Placage de bois (merisier)	39 41 42 43 44 46 48 49	1	90845
Wood veneer (walnut) Placage de bois (noyer)	47 96	1	90846
Thermo fused laminate (TFL) Panneau laminé	28 30 33 34	1	90554



Belleville 50514 EXTENDABLE TABLE TABLE EXTENSIBLE

TABLE BASE (table height)

BASE DE TABLE (hauteur table)

in/po	W/L	D/P	H
Overall/Hors-tout	28 3/8	54 7/8	29 3/4
Distance between legs at seat height Distance entre les pattes à la hauteur siège	20 3/4	44 7/8	18

Shown with 90461 tabletop/ Montrée avec le dessus de table 90461
Colors shown/ Couleurs montrées : Titanium (56)/ Stone dust (89)



FEATURES

- Opens easily and effortlessly by one person
- Ball bearing slide mechanism
- Built-in leaf storage

CARACTÉRISTIQUES

- Ouverture simple et sans effort par une seule personne
- Mécanisme de coulisses à billes synchronisées
- Rangement intégré pour les rallonges

COMPATIBLE TABLETOPS DESSUS DE TABLE COMPATIBLES		Thickness Épaisseur in/po	38 1/8 x 60+15	38 1/8 x 60+15 (2)
Solid wood (birch) Bois massif (merisier)	Distressed/Usé	1 1/2	90465	90461
	Non-distressed/Non usé	1 1/2	90464	90460
Solid wood (ash) Bois massif (frêne)		1 1/2	93465	93461
Wood veneer (birch) Placage de bois (merisier)		1		90891
Wood veneer (walnut) Placage de bois (noyer)		1		90892
Thermo fused laminate (TFL) Panneau laminé		1		90591



Bennington 50660 FOR WOOD TABLETOP
POUR DESSUS EN BOIS

TABLE BASE (table height)	BASE DE TABLE (hauteur table)		
in/po	W/L	D/P	H
Overall/Hors-tout	38 3/4	70 3/4	28 7/8
Distance between legs at seat height Distance entre les pattes à la hauteur siège	34 3/4	66 3/4	18

Shown with 93487 tabletop / Montrée avec le dessus de table 93487
Colors shown / Couleurs montrées : Metallo (57) / Anthracite (A6)

Bennington 50660-36 FOR WOOD TABLETOP
POUR DESSUS EN BOIS

PUB TABLE BASE (counter height)	BASE DE TABLE PUB (hauteur comptoir)		
in/po	W/L	D/P	H
Overall/Hors-tout	38 3/4	70 3/4	34 7/8
Distance between legs at seat height Distance entre les pattes à la hauteur siège	34 3/4	66 3/4	26

Bennington 50660-42 FOR WOOD TABLETOP
POUR DESSUS EN BOIS

PUB TABLE BASE (bar height)	BASE DE TABLE PUB (hauteur bar)		
in/po	W/L	D/P	H
Overall/Hors-tout	38 3/4	70 3/4	40 7/8
Distance between legs at seat height Distance entre les pattes à la hauteur siège	34 3/4	66 3/4	30

Shown with 93487 tabletop / Montrée avec le dessus de table 93487
Colors shown / Couleurs montrées : Metallo (57) / Anthracite (A6)

COMPATIBLE TABLETOPS DESSUS DE TABLE COMPATIBLES		Thickness Épaisseur in/po	39 1/2 x 71 1/2	40 x 72
Solid wood (birch) Bois massif (merisier)	Distressed / Usé 78 79 80 81 82 84 86 87 89 93	1 1/2		90487
	Non-distressed / Non usé 39 41 42 43 44 46 47 48 49 96	1 1/2		90486
Solid wood (ash) Bois massif (frêne)	A1 A2 A3 A6 A7 A8 A9 AA AV	1 1/2		93487
Wood veneer (birch) Placage de bois (merisier)	39 41 42 43 44 46 48 49	1	90863	
Wood veneer (walnut) Placage de bois (noyer)	47 96	1	90865	
Thermo fused laminate (TFL) Panneau laminé	28 30 33 34	1	90563	
		15/8		90586



Bennington 50960 FOR GLASS TABLETOP POUR DESSUS EN VERRE

TABLE BASE (table height)	BASE DE TABLE (hauteur table)		
in/ po	W/L	D/P	H
Overall/ <i>Hors-tout</i>	38 3/4	70 3/4	29
Distance between legs at seat height <i>Distance entre les pattes à la hauteur siège</i>	34 3/4	66 3/4	18

Shown with 90261 tabletop/ *Montrée avec le dessus de table 90261*
Color shown/ *Couleur montrée* : Metallo (57)

Bennington 50960-36 FOR GLASS TABLETOP POUR DESSUS EN VERRE

PUB TABLE BASE (counter height)	BASE DE TABLE PUB (hauteur comptoir)		
in/ po	W/L	D/P	H
Overall/ <i>Hors-tout</i>	38 3/4	70 3/4	35
Distance between legs at seat height <i>Distance entre les pattes à la hauteur siège</i>	34 3/4	66 3/4	26

Bennington 50960-42 FOR GLASS TABLETOP POUR DESSUS EN VERRE

PUB TABLE BASE (bar height)	BASE DE TABLE PUB (hauteur bar)		
in/ po	W/L	D/P	H
Overall/ <i>Hors-tout</i>	38 3/4	70 3/4	41
Distance between legs at seat height <i>Distance entre les pattes à la hauteur siège</i>	34 3/4	66 3/4	30

Shown with 90261 tabletop/ *Montrée avec le dessus de table 90261*
Color shown/ *Couleur montrée* : Metallo (57)

COMPATIBLE TABLETOPS DESSUS DE TABLE COMPATIBLES		Thickness <i>Épaisseur</i> in/ po	39 1/2 x 71 1/2
Clear glass <i>Verre clair</i>	Clear <i>Clair</i>	1/2	90271
Mat black glass <i>Verre noir mat</i>	Mat black <i>Noir mat</i>	1/2	90261
Ultra white glass <i>Verre ultra blanc</i>	Ultra white <i>Ultra blanc</i>	1/2	90281
Porcelain on glass <i>Porcelaine sur verre</i>	Black marble finish <i>Fini marbre noir</i>	1/2	91291
	Statuario marble finish <i>Fini marbre statuario</i>	1/2	90291
Starstone on glass <i>Starstone sur verre</i>	70 71	1/2	91281



Billy 50551

TABLE BASE
(table height)

BASE DE TABLE
(hauteur table)

in/po	W/L	D/P	H
Overall/Hors-tout	21 3/4	21 3/4	29

Shown with 90823 tabletop / Montrée avec le dessus de table 90823
Colors shown / Couleurs montrées : Titanium (56) / Porter (44)



Billy 50551-36

PUB TABLE BASE
(counter height)

BASE DE TABLE PUB
(hauteur comptoir)

in/po	W/L	D/P	H
Overall/Hors-tout	21 3/4	21 3/4	35

Billy 50551-42

PUB TABLE BASE
(bar height)

BASE DE TABLE PUB
(hauteur bar)

in/po	W/L	D/P	H
Overall/Hors-tout	21 3/4	21 3/4	41

Shown with 90817 tabletop / Montrée avec le dessus de table 90817
Colors shown / Couleurs montrées : Titanium (56) / Porter (44)

COMPATIBLE TABLETOPS DESSUS DE TABLE COMPATIBLES		Thickness Épaisseur in/po	30 dia.	36 dia.	39 dia.	42 dia.	36 x 36
Solid wood (birch) Bois massif (merisier)	Distressed/Usé	78 79 80 81 82 84 86 87 89 93	1 1/16	90403	90406	90412	90408
	Non-distressed/Non usé	39 41 42 43 44 46 47 48 49 96					
Solid wood (ash) Bois massif (frêne)	A1 A2 A3 A6 A7 A8 A9 AA AV	1 1/16		93406		93412	93408
Wood veneer (birch) Placage de bois (merisier)	39 41 42 43 44 46 48 49	1	90810	90817		90823	90827
Wood veneer (walnut) Placage de bois (noyer)	47 96	1	90811	90818		90824	90828
Thermo fused laminate (TFL) Panneau laminé	28 30 33 34	1	90528		90539		90527



Boomerang 50533 FOR TABLETOP WITH BUTTERFLY LEAF POUR DESSUS AVEC RALLONGE PAPILLON

TABLE BASE

(table height)

BASE DE TABLE

(hauteur table)

Cross beam in solid wood (birch) *Traverse en bois massif (merisier)*

Wood colors available / Couleurs de bois disponibles

39	41	42	43	44	46	47	48	49	96
----	----	----	----	----	----	----	----	----	----

in/po	W/L	D/P	H
Overall/Hors-tout	30 1/4	55	29
Distance between legs at seat height <i>Distance entre les pattes à la hauteur siège</i>	7	33 3/4	18

Shown with 90896 tabletop / *Montrée avec le dessus de table 90896*

Colors shown / *Couleurs montrées* : Black coral / *Noir corail* (25) / Pine cone (96)

FEATURES

- Opens easily and effortlessly by one person
- Ball bearing slide mechanism
- Built-in leaf storage

CARACTÉRISTIQUES

- Ouverture simple et sans effort par une seule personne
- Mécanisme de coulisses à billes synchronisées
- Rangement intégré pour les rallonges

COMPATIBLE TABLETOPS DESSUS DE TABLE COMPATIBLES		Thickness Épaisseur in/po	Oval / Ovale 38 x 72+24	Radius corners Coins arrondis 38 x 72+24	Square corners Coins carrés 38 x 72+24
Wood veneer (birch) <i>Placage de bois (merisier)</i>	39 41 42 43 44 46 48 49	1	90895	90893	90888
Wood veneer (walnut) <i>Placage de bois (noyer)</i>	47 96	1	90896	90894	90889
Thermo fused laminate (TFL) <i>Panneau laminé</i>	28 30 33 34	1	90595	90594	90592



Burton 50557

TABLE BASE (table height)

BASE DE TABLE (hauteur table)

in/po	Tabletops Dessus de table	W/L	D/P	H
Overall/Hors-tout		27 7/8	4	29 3/8
Distance between legs at seat height Distance entre les pattes à la hauteur siège	32 x 54	—	39 1/8	18
Distance between legs at seat height Distance entre les pattes à la hauteur siège	36 x 60	—	44 7/8	18

in/po	Tabletops Dessus de table	W/L	D/P	H
Distance between legs at seat height Distance entre les pattes à la hauteur siège	40 x 72	—	43	18
Distance between legs at seat height Distance entre les pattes à la hauteur siège	40 x 84	—	55	18

Shown with 90487 tabletop / Montrée avec le dessus de table 90487
Colors shown / Couleurs montrées : Magnetite (24) / Stone dust (89)

COMPATIBLE TABLETOPS DESSUS DE TABLE COMPATIBLES		Thickness Épaisseur in/po	32 x 54	36 x 60	38 x 72	39 1/2 x 71 1/2	40 x 72	38 x 84	39 1/2 x 83 1/2	40 x 84	40 x 72 +18 (2)	40 x 84 +18 (2)
Solid wood (birch) Bois massif (merisier)	Distressed/Usé	1 1/2	90405*	90410* 91462			90487			90485	90483	90481
	78 79 80 81 82 84 86 87 89 93											
Solid wood (birch) with decorative bolts Bois massif (merisier) avec vis décoratives	Non-distressed/Non usé	1 1/2		91461			90486			90484	90482	90480
	39 41 42 43 44 46 47 48 49 96											
	A1 A2 A3 A6 A7 A8 A9 AA AV											
Solid wood (ash) Bois massif (frêne)		1 1/2					93487			93485	93483	93481
		1 1/16		93410 93460	93472			93484				
Wood veneer (birch) Placage de bois (merisier)		1	90845	90860		90863			90864			
	39 41 42 43 44 46 48 49											
Wood veneer (walnut) Placage de bois (noyer)		1	90846	90861		90865			90866			
	47 96											
Thermo fused laminate (TFL) Panneau laminé		1		90536		90563			90564			
	28 30 33 34											
		15/8		90562			90586			90585		

*Thickness of 11/16 / Épaisseur de 1/16



Calypso 51520 FOR WOOD TABLETOP
POUR DESSUS EN BOIS

NEW
TABLE BASE
(table height)

NOUVEAU
BASE DE TABLE
(hauteur table)

in/po	W/L	D/P	H
Overall/Hors-tout	24	24	29

Shown with 90824 tabletop / Montrée avec le dessus de table 90824
Colors shown / Couleurs montrées : Black coral / Noir corail (25) /
Pine cone (96)



Calypso 51520-36 FOR WOOD TABLETOP
POUR DESSUS EN BOIS

NEW
PUB TABLE BASE
(counter height)

NOUVEAU
BASE DE TABLE PUB
(hauteur comptoir)

in/po	W/L	D/P	H
Overall/Hors-tout	24	24	35

Shown with 90548 tabletop / Montrée avec le dessus de table 90548
Colors shown / Couleurs montrées : Black coral / Noir corail (25) /
Basalt (30)

Calypso 51520-42 FOR WOOD TABLETOP
POUR DESSUS EN BOIS

NEW
PUB TABLE BASE
(bar height)

NOUVEAU
BASE DE TABLE PUB
(hauteur bar)

in/po	W/L	D/P	H
Overall/Hors-tout	24	24	41

COMPATIBLE TABLETOPS DESSUS DE TABLE COMPATIBLES		Thickness Épaisseur in/po	39 dia.	42 dia.	48 dia.
Solid wood (birch) Bois massif (merisier)	Distressed / Usé	1 1/16		90412	
	78 79 80 81 82 84 86 87 89 93				
Solid wood (ash) Bois massif (frêne)	Non-distressed / Non usé	1 1/16		93412	
	39 41 42 43 44 46 47 48 49 96				
Wood veneer (birch) Placage de bois (merisier)	A1 A2 A3 A6 A7 A8 A9 AA AV	1		90823	90857
Wood veneer (walnut) Placage de bois (noyer)	47 96	1		90824	90858
Thermo fused laminate (TFL) Panneau laminé	28 30 33 34	1	90539		90548*

*Auburn (28) only / seulement.



Calypso 51521

FOR WOOD VENEER AND THERMO FUSED LAMINATE (TFL) TABLETOP
 POUR DESSUS DE PLACAGE DE BOIS ET PANNEAU LAMINÉ (TFL)

NEW
TABLE BASE
 (table height)

NOUVEAU
BASE DE TABLE
 (hauteur table)

in/po	W/L	D/P	H
Overall/Hors-tout	24	46	29

Shown with 90840 tabletop / Montrée avec le dessus de table 90840
 Colors shown / Couleurs montrées : Black coral / Noir corail (25) /
 Mouse (49)

COMPATIBLE TABLETOPS DESSUS DE TABLE COMPATIBLES		Thickness Épaisseur in/po	39 1/2 x 71 1/2	40 x 72	40 x 72
Wood veneer (birch) Placage de bois (merisier)	39 41 42 43 44 46 48 49	1	90863		90840
Wood veneer (walnut) Placage de bois (noyer)	47 96	1	90865		90841
Thermo fused laminate (TFL) Panneau laminé	28 30 33 34	1	90563		90542
		1 5/8		90586	



Calypso 51522 FOR GLASS TABLETOP
POUR DESSUS EN VERRE

NEW
TABLE BASE
(table height)

NOUVEAU
BASE DE TABLE
(hauteur table)

in/po	W/L	D/P	H
Overall/Hors-tout	24	24	29 5/8

Shown with 90282 tabletop / Montrée avec le dessus de table 90282
Colors shown / Couleurs montrées : Pure (61) / Ultra white glass



Calypso 51522-36 FOR GLASS TABLETOP
POUR DESSUS EN VERRE

NEW
PUB TABLE BASE
(counter height)

NOUVEAU
BASE DE TABLE PUB
(hauteur comptoir)

in/po	W/L	D/P	H
Overall/Hors-tout	24	24	35 5/8

Calypso 51522-42 FOR GLASS TABLETOP
POUR DESSUS EN VERRE

NEW
PUB TABLE BASE
(bar height)

NOUVEAU
BASE DE TABLE PUB
(hauteur bar)

in/po	W/L	D/P	H
Overall/Hors-tout	24	24	41 5/8

Shown with 90282 tabletop / Montrée avec le dessus de table 90282
Colors shown / Couleurs montrées : Pure (61) / Ultra white glass /
Verre ultra blanc

COMPATIBLE TABLETOPS DESSUS DE TABLE COMPATIBLES		Thickness Épaisseur in/po	39 dia.	42 dia.	48 dia.
Mat black glass Verre noir mat	Mat black Noir mat	1/2		90262	90267
Ultra white glass Verre ultra blanc	Ultra white Ultra blanc	1/2		90282	90287
Porcelain on glass Porcelaine sur verre	Black marble finish Fini marbre noir	1/2	91292		
	Statuario marble finish Fini marbre statuario	1/2	90292		
Starstone on glass Starstone sur verre	70 71	1/2		91282	91287



Calypso 51523 FOR GLASS TABLETOP POUR DESSUS EN VERRE

NEW
TABLE BASE
(table height)

NOUVEAU
BASE DE TABLE
(hauteur table)

in/po	W/L	D/P	H
Overall / Hors-tout	24	46	29 5/8

Shown with 91291 tabletop / Montrée avec le dessus de table 91291
Colors shown / Couleurs montrées : Sugar bronze (69) /
Porcelain on glass (black marble finish) / Porcelaine sur verre
(fini marbre noir)

COMPATIBLE TABLETOPS DESSUS DE TABLE COMPATIBLES			Thickness Épaisseur in/po	39 1/2 x 71 1/2
Mat black glass Verre noir mat	Mat black Noir mat		1/2	90261
Ultra white glass Verre ultra blanc	Ultra white Ultra blanc		1/2	90281
Porcelain on glass Porcelaine sur verre	Black marble finish Fini marbre noir		1/2	91291
	Statuario marble finish Fini marbre statuario		1/2	90291
Starstone on glass Starstone sur verre	70 71		1/2	91281



Calypso 51524 FOR GLASS TABLETOP POUR DESSUS EN VERRE

NEW TABLE BASE (table height)

With thermo fused laminate
(TFL) accent

NOUVEAU BASE DE TABLE (hauteur table)

Avec accent de panneau
laminé (TFL)

in/po	W/L	D/P	H
Overall/Hors-tout	24	24	30

Shown with 90242 tabletop / Montrée avec le dessus de table 90242
Colors shown / Couleurs montrées : Titanium (56) /
Auburn (28) / Clear glass / Verre clair

Thermo fused laminate colors available /
Couleurs de panneaux laminés disponibles

28	30	33	34
----	----	----	----



Calypso 51524-36 FOR GLASS TABLETOP POUR DESSUS EN VERRE

NEW PUB TABLE BASE (counter height)

With thermo fused laminate
(TFL) accent

NOUVEAU BASE DE TABLE PUB (hauteur comptoir)

Avec accent de panneau
laminé (TFL)

in/po	W/L	D/P	H
Overall/Hors-tout	24	24	36

Calypso 51524-42 FOR GLASS TABLETOP POUR DESSUS EN VERRE

NEW PUB TABLE BASE (bar height)

With thermo fused laminate
(TFL) accent

NOUVEAU BASE DE TABLE PUB (hauteur bar)

Avec accent de panneau
laminé (TFL)

in/po	W/L	D/P	H
Overall/Hors-tout	24	24	42

Shown with 90242 tabletop / Montrée avec le dessus de table 90242
Colors shown / Couleurs montrées : Titanium (56) / Auburn (28) /
Clear glass / Verre clair

COMPATIBLE TABLETOPS DESSUS DE TABLE COMPATIBLES		Thickness Épaisseur in/po	42 dia. 	48 dia.
Clear glass Verre clair	Clear Clair	1/2	90242	90247
Clear glass (beveled edge) Verre clair (chant biseau)	Clear Clair	3/8	90375	90378



Calypso 51525 FOR GLASS TABLETOP
 POUR DESSUS EN VERRE

NEW
TABLE BASE
 (table height)

With thermo fused laminate
 (TFL) accent

NOUVEAU
BASE DE TABLE
 (hauteur table)

Avec accent de panneau
 laminé (TFL)

Thermo fused laminate colors available/
 Couleurs de panneaux laminés disponibles

- 28
- 30
- 33
- 34

in/po	W/L	D/P	H
Overall/Hors-tout	24	46	30

Shown with 90271 tabletop / Montrée avec le dessus de table 90271
 Colors shown / Couleurs montrées : Pure (61) / Almond (33) / Clear glass /
 Verre clair

COMPATIBLE TABLETOP DESSUS DE TABLE COMPATIBLE		Thickness Épaisseur in / po	39 1/2 x 71 1/2 
Clear glass Verre clair	Clear Clair	1/2	90271



Calypso 51526 FOR GLASS TABLETOP POUR DESSUS EN VERRE

NEW TABLE BASE (table height)

With wood veneer
(birch) accent

NOUVEAU BASE DE TABLE (hauteur table)

Avec accent de placage
de bois (merisier)

in/po	W/L	D/P	H
Overall/Hors-tout	24	24	30

Shown with 90247 tabletop / Montrée avec le dessus de table 90247
Colors shown / Couleurs montrées : Sugar bronze (69) / Café (43) /
Clear glass / Verre clair

Wood veneer (birch) colors available /
Couleurs de placage de bois (merisier) disponibles

39	41	42	43	44	46	48	49
----	----	----	----	----	----	----	----



Calypso 51526-36 FOR GLASS TABLETOP POUR DESSUS EN VERRE

NEW PUB TABLE BASE (counter height)

With wood veneer
(birch) accent

NOUVEAU BASE DE TABLE PUB (hauteur comptoir)

Avec accent de placage
de bois (merisier)

in/po	W/L	D/P	H
Overall/Hors-tout	24	24	36

Shown with 90247 tabletop / Montrée avec le dessus de table 90247
Colors shown / Couleurs montrées : Sugar bronze (69) / Café (43) /
Clear glass / Verre clair

Calypso 51526-42 FOR GLASS TABLETOP POUR DESSUS EN VERRE

NEW PUB TABLE BASE (bar height)

With wood veneer
(birch) accent

NOUVEAU BASE DE TABLE PUB (hauteur bar)

Avec accent de placage
de bois (merisier)

in/po	W/L	D/P	H
Overall/Hors-tout	24	24	42

COMPATIBLE TABLETOPS DESSUS DE TABLE COMPATIBLES		Thickness Épaisseur in / po	42 dia. 	48 dia.
Clear glass Verre clair	Clear Clair	1/2	90242	90247
Clear glass (beveled edge) Verre clair (chant biseau)	Clear Clair	3/8	90375	90378



Calypso 51527 FOR GLASS TABLETOP POUR DESSUS EN VERRE

NEW
TABLE BASE
(table height)

With wood veneer
(birch) accent

NOUVEAU
BASE DE TABLE
(hauteur table)

Avec accent de placage
de bois (merisier)

Wood veneer (birch) colors available/
Couleurs de placage de bois (merisier) disponibles

39	41	42	43	44	46	48	49
----	----	----	----	----	----	----	----

in/po	W/L	D/P	H
Overall/Hors-tout	24	46	30

Shown with 90271 tabletop / Montrée avec le dessus de table 90271
Colors shown / Couleurs montrées : Titanium (56) / Earl grey (48) /
Clear glass / Verre clair

COMPATIBLE TABLETOP DESSUS DE TABLE COMPATIBLE		Thickness Épaisseur in / po	39 1/2 x 71 1/2 
Clear glass Verre clair	Clear Clair	1/2	90271



Calypso 51528 FOR GLASS TABLETOP POUR DESSUS EN VERRE

NEW TABLE BASE (table height)

With wood veneer
(walnut) accent

NOUVEAU BASE DE TABLE (hauteur table)

Avec accent de placage
de bois (noyer)

in/po	W/L	D/P	H
Overall/Hors-tout	24	24	30

Shown with 90375 tabletop / Montrée avec le dessus de table 90375
Colors shown / Couleurs montrées : Oxidado (52) / Tiramisu (47) / Clear glass / Verre clair

Wood veneer (walnut) colors available /
Couleurs de placage de bois (noyer) disponibles

47 96



Calypso 51528-36 FOR GLASS TABLETOP POUR DESSUS EN VERRE

NEW PUB TABLE BASE (counter height)

With wood veneer
(walnut) accent

NOUVEAU BASE DE TABLE PUB (hauteur comptoir)

Avec accent de placage
de bois (noyer)

in/po	W/L	D/P	H
Overall/Hors-tout	24	24	36

Shown with 90375 tabletop / Montrée avec le dessus de table 90375
Colors shown / Couleurs montrées : Oxidado (52) / Tiramisu (47) / Clear glass / Verre clair

Calypso 51528-42 FOR GLASS TABLETOP POUR DESSUS EN VERRE



NEW PUB TABLE BASE (bar height)

With wood veneer
(walnut) accent

NOUVEAU BASE DE TABLE PUB (hauteur bar)

Avec accent de placage
de bois (noyer)

in/po	W/L	D/P	H
Overall/Hors-tout	24	24	42

COMPATIBLE TABLETOPS DESSUS DE TABLE COMPATIBLES		Thickness Épaisseur in / po	42 dia. 	48 dia. 
Clear glass Verre clair	Clear Clair	1/2	90242	90247
Clear glass (beveled edge) Verre clair (chant biseau)	Clear Clair	3/8	90375	90378



Calypso 51529 FOR GLASS TABLETOP
POUR DESSUS EN VERRE

NEW
TABLE BASE
(table height)

With wood veneer
(walnut) accent

NOUVEAU
BASE DE TABLE
(hauteur table)

Avec accent de placage
de bois (noyer)

Wood veneer (walnut) colors available/
Couleurs de placage de bois (noyer) disponibles

47 96

in/po	W/L	D/P	H
Overall/Hors-tout	24	46	30

Shown with 90271 tabletop / Montrée avec le dessus de table 90271
Colors shown / Couleurs montrées : Black coral / Noir corail (25) /
Pine cone (96) / Clear glass / Verre clair

COMPATIBLE TABLETOPS DESSUS DE TABLE COMPATIBLE		Thickness Épaisseur in / po	39 1/2 x 71 1/2 
Clear glass Verre clair	Clear Clair	1/2	90271



Carbon 50662 FOR WOOD TABLETOP
POUR DESSUS EN BOIS

TABLE BASE
(table height)

BASE DE TABLE
(hauteur table)

in/po	W/L	D/P	H
Overall/Hors-tout	35 1/4	35 1/4	28 7/8
Distance between legs at seat height Distance entre les pattes à la hauteur siège	31 3/4	31 3/4	18

Shown with 90827 tabletop / Montrée avec le dessus de table 90827
Colors shown / Couleurs montrées : Titanium (56) / Earl grey (48)



Carbon 50662-36 FOR WOOD TABLETOP
POUR DESSUS EN BOIS

PUB TABLE BASE
(counter height)

BASE DE TABLE PUB
(hauteur comptoir)

in/po	W/L	D/P	H
Overall/Hors-tout	35 1/4	35 1/4	34 7/8
Distance between legs at seat height Distance entre les pattes à la hauteur siège	31 3/4	31 3/4	26

Carbon 50662-42 FOR WOOD TABLETOP
POUR DESSUS EN BOIS

PUB TABLE BASE
(bar height)

BASE DE TABLE PUB
(hauteur bar)

in/po	W/L	D/P	H
Overall/Hors-tout	35 1/4	35 1/4	40 7/8
Distance between legs at seat height Distance entre les pattes à la hauteur siège	31 3/4	31 3/4	30

Shown with 90827 tabletop / Montrée avec le dessus de table 90827
Colors shown / Couleurs montrées : Titanium (56) / Earl grey (48)

COMPATIBLE TABLETOPS DESSUS DE TABLE COMPATIBLES		Thickness Épaisseur in/po	36 x 36
Solid wood (birch) Bois massif (merisier)	Distressed / Usé 78 79 80 81 82 84 86 87 89 93	1 1/16	90408
	Non-distressed / Non usé 39 41 42 43 44 46 47 48 49 96		
Solid wood (ash) Bois massif (frêne)	A1 A2 A3 A6 A7 A8 A9 AA AV	1 1/16	93408
Wood veneer (birch) Placage de bois (merisier)	39 41 42 43 44 46 48 49	1	90827
Wood veneer (walnut) Placage de bois (noyer)	47 96	1	90828
Thermo fused laminate (TFL) Panneau laminé	28 30 33 34	1	90527



Carbon 50962 FOR GLASS TABLETOP POUR DESSUS EN VERRE

TABLE BASE (table height)

BASE DE TABLE (hauteur table)

in/po	W/L	D/P	H
Overall/Hors-tout	35 1/4	35 1/4	29
Distance between legs at seat height Distance entre les pattes à la hauteur siège	31 3/4	31 3/4	18

Shown with 90246 tabletop / Montrée avec le dessus de table 90246
Color shown / Couleur montrée : Titanium (56)



Carbon 50962-36 FOR GLASS TABLETOP POUR DESSUS EN VERRE

PUB TABLE BASE (counter height)

BASE DE TABLE PUB (hauteur comptoir)

in/po	W/L	D/P	H
Overall/Hors-tout	35 1/4	35 1/4	35
Distance between legs at seat height Distance entre les pattes à la hauteur siège	31 3/4	31 3/4	26





Carbon 50962-42 FOR GLASS TABLETOP POUR DESSUS EN VERRE

PUB TABLE BASE (bar height)

BASE DE TABLE PUB (hauteur bar)

in/po	W/L	D/P	H
Overall/Hors-tout	35 1/4	35 1/4	41
Distance between legs at seat height Distance entre les pattes à la hauteur siège	31 3/4	31 3/4	30

Shown with 90246 tabletop / Montrée avec le dessus de table 90246
Color shown / Couleur montrée : Titanium (56)

COMPATIBLE TABLETOPS DESSUS DE TABLE COMPATIBLES		Thickness Épaisseur in/po	36 x 36 
Clear glass Verre clair		1/2	90246
Mat black glass Verre noir mat		1/2	90269
Ultra white glass Verre ultra blanc		1/2	90289



Dalia 50507

TABLE BASE (table height)

BASE DE TABLE (hauteur table)

in/po	W/L	D/P	H
Overall/Hors-tout	24	24	29 1/2

Shown with 90236 tabletop / Montrée avec le dessus de table 90236
Color shown / Couleur montrée : –



Dalia 50507-38

PUB TABLE BASE (counter height)

BASE DE TABLE PUB (hauteur comptoir)

in/po	W/L	D/P	H
Overall/Hors-tout	24	24	37 1/2

Shown with 93406 tabletop / Montrée avec le dessus de table 93406
Colors shown / Couleurs montrées : Metallo (57) / Leche (AA)

Dalia 50507-42

PUB TABLE BASE (bar height)

BASE DE TABLE PUB (hauteur bar)

in/po	W/L	D/P	H
Overall/Hors-tout	24	24	41 1/2

COMPATIBLE TABLETOPS DESSUS DE TABLE COMPATIBLES		Thickness Épaisseur in/po	30 dia.	36 dia.	39 dia.	42 dia.	36 x 36
Solid wood (birch) Bois massif (merisier)	Distressed / Usé	78 79 80 81 82 84 86 87 89 93	11/16	90403	90406	90412	90408
	Non-distressed / Non usé	39 41 42 43 44 46 47 48 49 96					
Solid wood (ash) Bois massif (frêne)	A1 A2 A3 A6 A7 A8 A9 AA AV	11/16		93406		93412	93408
Wood veneer (birch) Placage de bois (merisier)	39 41 42 43 44 46 48 49	1	90810	90817		90823	90827
Wood veneer (walnut) Placage de bois (noyer)	47 96	1	90811	90818		90824	90828
Thermo fused laminate (TFL) Panneau laminé	28 30 33 34	1	90528		90539		90527
Clear glass Verre clair	Clear Clair	1/2	90230	90236		90242	90246
Clear glass (beveled edge) Verre clair (chant biseau)	Clear Clair	3/8		90376		90375	
Mat black glass Verre noir mat	Mat black Noir mat	1/2		90266		90262	90269
Ultra white glass Verre ultra blanc	Ultra white Ultra blanc	1/2		90286		90282	90289
Porcelain on glass Porcelaine sur verre	Black marble finish Fini marbre noir	1/2			91292		
	Statuario marble finish Fini marbre statuario	1/2			90292		
Starstone on glass Starstone sur verre	70 71	1/2		91286		91282	



Dalia XL 50547

TABLE BASE
(table height)

BASE DE TABLE
(hauteur table)

in/po	W/L	D/P	H
Overall/Hors-tout	29 1/2	29 1/2	28 7/8

Shown with 90267 tabletop / Montrée avec le dessus de table 90267
Color shown / Couleur montrée : Black coral / Noir corail (25)

COMPATIBLE TABLETOPS DESSUS DE TABLE COMPATIBLES									Thickness Épaisseur in/ po	48 dia. 
Wood veneer (birch) Placage de bois (merisier)	39	41	42	43	44	46	48	49	1	90857
Wood veneer (walnut) Placage de bois (noyer)	47	96							1	90858
Thermo fused laminate (TFL) Panneau laminé	28								1	90548
Clear glass Verre clair	Clear Clair								1/2	90247
Clear glass (beveled edge) Verre clair (chant biseau)	Clear Clair								3/8	90378
Mat black glass Verre noir mat	Mat black Noir mat								1/2	90267
Ultra white glass Verre ultra blanc	Ultra white Ultra blanc								1/2	90287
Starstone on glass Starstone sur verre	70	71							1/2	91287

*Auburn (28) only / seulement.



Dirk 50634

TABLE BASE
(table height)

BASE DE TABLE
(hauteur table)

in/po	W/L	D/P	H
Overall/Hors-tout	23	23	29 1/2

Shown with 90823 tabletop / Montrée avec le dessus de table 90823
Colors shown / Couleurs montrées : Titanium (56)/Porter (44)

COMPATIBLE TABLETOPS DESSUS DE TABLE COMPATIBLES		Thickness Épaisseur in/po	36 dia.	39 dia.	42 dia.	48 dia.	36 x 36
Solid wood (birch) <i>Bois massif (merisier)</i>	Distressed / Usé 78 79 80 81 82 84 86 87 89 93	1 1/16	90406		90412		90408
	Non-distressed / Non usé 39 41 42 43 44 46 47 48 49 96						
Solid wood (ash) <i>Bois massif (frêne)</i>	A1 A2 A3 A6 A7 A8 A9 AA AV	1 1/16	93406		93412		90408
Wood veneer (birch) <i>Placage de bois (merisier)</i>	39 41 42 43 44 46 48 49	1	90817		90823	90857	90827
Wood veneer (walnut) <i>Placage de bois (noyer)</i>	47 96	1	90818		90824	90858	90828
Thermo fused laminate (TFL) <i>Panneau laminé</i>	28 30 33 34	1		90539		*90548	90527
Clear glass <i>Verre clair</i>	Clear <i>Clair</i>	1/2	90236		90242	90247	90246
Clear glass (beveled edge) <i>Verre clair (chant biseau)</i>	Clear <i>Clair</i>	3/8	90376		90375	90378	
Mat black glass <i>Verre noir mat</i>	Mat black <i>Noir mat</i>	1/2	90266		90262	90267	90269
Ultra white glass <i>Verre ultra blanc</i>	Ultra white <i>Ultra blanc</i>	1/2	90286		90282	90287	90289
Porcelain on glass <i>Porcelaine sur verre</i>	Black marble finish <i>Fini marbre noir</i>	1/2		91292			
	Statuario marble finish <i>Fini marbre statuario</i>	1/2		90292			
Starstone on glass <i>Starstone sur verre</i>	70 71	1/2	91286		91282	91287	

*Auburn (28) only / seulement.



Dirk 50734

PUB TABLE BASE
(counter height)

BASE DE TABLE PUB
(hauteur comptoir)

in/ po	W/L	D/P	H
Overall/Hors-tout	23	23	37





Dirk 50834

PUB TABLE BASE
(bar height)

BASE DE TABLE PUB
(hauteur bar)

in/ po	W/L	D/P	H
Overall/Hors-tout	23	23	41

Shown with 90292 tabletop / Montrée avec le dessus de table 90292
Color shown / Couleur montrée : Dayglam (53) / Porcelain on glass statuario
marble finish / Porcelaine sur verre fini marbre statuario

COMPATIBLE TABLETOPS DESSUS DE TABLE COMPATIBLES		Thickness Épaisseur in/ po	36 dia. 	39 dia. 	42 dia. 	36 x 36 
Solid wood (birch) Bois massif (merisier)	Distressed / Usé 78 79 80 81 82 84 86 87 89 93	1 1/16	90406		90412	90408
	Non-distressed / Non usé 39 41 42 43 44 46 47 48 49 96					
Solid wood (ash) Bois massif (frêne)	A1 A2 A3 A6 A7 A8 A9 AA AV	1 1/16	93406		93412	90408
Wood veneer (birch) Placage de bois (merisier)	39 41 42 43 44 46 48 49	1	90817		90823	90827
Wood veneer (walnut) Placage de bois (noyer)	47 96	1	90818		90824	90828
Thermo fused laminate (TFL) Panneau laminé	28 30 33 34	1		90539		90527
Clear glass Verre clair	Clear Clair	1/2	90236		90242	90246
Clear glass (beveled edge) / Verre clair (chant biseau)	Clear Clair	3/8	90376		90375	
Mat black glass Verre noir mat	Mat black Noir mat	1/2	90266		90262	90269
Ultra white glass Verre ultra blanc	Ultra white Ultra blanc	1/2	90286		90282	90289
	Black marble finish Fini marbre noir	1/2		91292		
Porcelain on glass Porcelaine sur verre	Statuario marble finish Fini marbre statuario	1/2		90292		
Starstone on glass Starstone sur verre	70 71	1/2	91286		91282	



Harrison 50668 FOR WOOD TABLETOP POUR DESSUS EN BOIS

TABLE BASE (table height)	BASE DE TABLE (hauteur table)		
in/po	W/L	D/P	H
Overall/Hors-tout	27 1/4	47 1/4	28 7/8
Distance between legs at seat height Distance entre les pattes à la hauteur siège	23 3/4	43 3/4	18

Shown with 90851 tabletop/Montrée avec le dessus de table 90851
Colors shown/Couleurs montrées : Titanium (56)/Milk (80)

Harrison 50668-36 FOR WOOD TABLETOP POUR DESSUS EN BOIS

PUB TABLE BASE (counter height)	BASE DE TABLE PUB (hauteur comptoir)		
in/po	W/L	D/P	H
Overall/Hors-tout	27 1/4	47 1/4	34 7/8
Distance between legs at seat height Distance entre les pattes à la hauteur siège	23 3/4	43 3/4	26

Harrison 50668-42 FOR WOOD TABLETOP POUR DESSUS EN BOIS

PUB TABLE BASE (bar height)	BASE DE TABLE PUB (hauteur bar)		
in/po	W/L	D/P	H
Overall/Hors-tout	27 1/4	47 1/4	40 7/8
Distance between legs at seat height Distance entre les pattes à la hauteur siège	23 3/4	43 3/4	30

Shown with 90851 tabletop/Montrée avec le dessus de table 90851
Colors shown/Couleurs montrées : Titanium (56)/Milk (80)

COMPATIBLE TABLETOPS DESSUS DE TABLE COMPATIBLES		Thickness Épaisseur in/po	28 x 48
Solid wood (birch) Bois massif (merisier)	Distressed/Usé 78 79 80 81 82 84 86 87 89 93	1 1/16	90851
	Non-distressed/Non usé 39 41 42 43 44 46 47 48 49 96		
Solid wood (ash) Bois massif (frêne)	A1 A2 A3 A6 A7 A8 A9 AA AV	1 1/16	93428
Wood veneer (birch) Placage de bois (merisier)	39 41 42 43 44 46 48 49	1	90849
Wood veneer (walnut) Placage de bois (noyer)	47 96	1	90850
Thermo fused laminate (TFL) Panneau laminé	28 30 33 34	1	90549



Harrison 50968

FOR GLASS TABLETOP
POUR DESSUS EN VERRE

TABLE BASE (table height)

BASE DE TABLE (hauteur table)

in/po	W/L	D/P	H
Overall/Hors-tout	27 1/4	47 1/4	29
Distance between legs at seat height Distance entre les pattes à la hauteur siège	23 3/4	43 3/4	18

Shown with 90268 tabletop / Montrée avec le dessus de table 90268
Color shown / Couleur montrée : Magnetite (24)

Harrison 50968-36

FOR GLASS TABLETOP
POUR DESSUS EN VERRE

PUB TABLE BASE (counter height)

BASE DE TABLE PUB (hauteur comptoir)

in/po	W/L	D/P	H
Overall/Hors-tout	27 1/4	47 1/4	35
Distance between legs at seat height Distance entre les pattes à la hauteur siège	23 3/4	43 3/4	26

Harrison 50968-42







FOR GLASS TABLETOP
POUR DESSUS EN VERRE

PUB TABLE BASE (bar height)

BASE DE TABLE PUB (hauteur bar)

in/po	W/L	D/P	H
Overall/Hors-tout	27 1/4	47 1/4	41
Distance between legs at seat height Distance entre les pattes à la hauteur siège	23 3/4	43 3/4	30

Shown with 90268 tabletop / Montrée avec le dessus de table 90268
Color shown / Couleur montrée : Magnetite (24)

COMPATIBLE TABLETOPS DESSUS DE TABLE COMPATIBLES		Thickness Épaisseur in/po	28 x 48 
Clear glass Verre clair	 Clear Clair	1/2	90248
Mat black glass Verre noir mat	 Mat black Noir mat	1/2	90268
Ultra white glass Verre ultra blanc	 Ultra white Ultra blanc	1/2	90288
Porcelain on glass Porcelaine sur verre	 Black marble finish Fini marbre noir	1/2	91298
	 Statuario marble finish Fini marbre statuario	1/2	90298
Starstone on glass Starstone sur verre	 70 71	1/2	91288



Hendrick 50532 FOR TABLETOP WITH BUTTERFLY LEAF POUR DESSUS AVEC RALLONGE PAPILLON

TABLE BASE (table height)

BASE DE TABLE (hauteur table)

in/po	W/L	D/P	H
Overall/Hors-tout	30 3/4	54 7/8	29
Distance between legs at seat height Distance entre les pattes à la hauteur siège	20 3/8	44 3/8	18



Shown with 90893 tabletop / Montrée avec le dessus de table 90893
Colors shown / Couleurs montrées : Black coral / Noir corail (25) / Earl grey (48)

FEATURES

- Opens easily and effortlessly by one person
- Ball bearing slide mechanism
- Built-in leaf storage

CARACTÉRISTIQUES

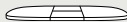
- Ouverture simple et sans effort par une seule personne
- Mécanisme de coulisses à billes synchronisées
- Rangement intégré pour les rallonges

COMPATIBLE TABLETOPS DESSUS DE TABLE COMPATIBLES									Thickness Épaisseur in/po	Oval / Ovale 38 x 72 + 24	Radius corners Coins arrondis 38 x 72 + 24	Square corners Coins carrés 38 x 72 + 24
												
Wood veneer (birch) Placage de bois (merisier)	39	41	42	43	44	46	48	49	1	90895	90893	90888
Wood veneer (walnut) Placage de bois (noyer)	47	96							1	90896	90894	90889
Thermo fused laminate (TFL) Panneau laminé	28	30	33	34					1	90595	90594	90592



Judy 50550

TABLE BASE
(table height)

BASE DE TABLE
(hauteur table)

in/po	W/L	D/P	H
Overall/Hors-tout	20 3/4	20 3/4	29

Shown with 90823 tabletop / Montrée avec le dessus de table 90823
Colors shown / Couleurs montrées : Metallo (57)/Porter (44)



Judy 50550-36

PUB TABLE BASE
(counter height)

BASE DE TABLE PUB
(hauteur comptoir)

in/po	W/L	D/P	H
Overall/Hors-tout	20 3/4	20 3/4	35

Judy 50550-42

PUB TABLE BASE
(bar height)

BASE DE TABLE PUB
(hauteur bar)

in/po	W/L	D/P	H
Overall/Hors-tout	20 3/4	20 3/4	41

Shown with 90817 tabletop / Montrée avec le dessus de table 90817
Colors shown / Couleurs montrées : Metallo (57)/Porter (44)

COMPATIBLE TABLETOPS DESSUS DE TABLE COMPATIBLES		Thickness Épaisseur in/po	30 dia.	36 dia.	39 dia.	42 dia.	36 x 36
Solid wood (birch) Bois massif (merisier)	Distressed / Usé	78 79 80 81 82 84 86 87 89 93	1 1/16	90403	90406	90412	90408
	Non-distressed / Non usé	39 41 42 43 44 46 47 48 49 96					
Solid wood (ash) Bois massif (frêne)	A1 A2 A3 A6 A7 A8 A9 AA AV	1 1/16		93406		93412	93408
Wood veneer (birch) Placage de bois (merisier)	39 41 42 43 44 46 48 49	1	90810	90817		90823	90827
Wood veneer (walnut) Placage de bois (noyer)	47 96	1	90811	90818		90824	90828
Thermo fused laminate (TFL) Panneau laminé	28 30 33 34	1	90528		90539		90527



Wood colors available/ Couleurs de bois disponibles
Distressed solid wood/ Bois massif usé

78	79	80	81	82	84	86	87	89	93	45
----	----	----	----	----	----	----	----	----	----	----

Non-distressed solid wood/ Bois massif non usé

39	41	42	43	44	46	47	48	49	96	85
----	----	----	----	----	----	----	----	----	----	----

Note : Wood components ordered in Unfinished (85) must be finished./ Note : Les composantes de bois commandées dans le fini Non peint (85) doivent être finies.

Kai 50607 FOR GLASS TABLETOP
POUR DESSUS EN VERRE

TABLE BASE
(table height)

With solid wood accent

BASE DE TABLE
(hauteur table)

Avec accent en bois massif

in/po	W/L	D/P	H
Overall/Hors-tout	31 1/2	31 1/2	30

Shown with 90375 tabletop/ Montrée avec le dessus de table 90375
Colors shown/ Couleurs montrées : Oxidado (52)/ Rumcherry (41)

COMPATIBLE TABLETOPS DESSUS DE TABLE COMPATIBLES		Thickness Épaisseur in/po	36 dia. 	39 dia. 	42 dia. 	48 dia.
Clear glass Verre clair	Clear Clair	1/2	90236		90242	90247
Clear glass (beveled edge) Verre clair (chant biseau)	Clear Clair	3/8	90376		90375	90378
Mat black glass Verre noir mat	Mat black Noir mat	1/2	90266		90262	90267
Ultra white glass Verre ultra blanc	Ultra white Ultra blanc	1/2	90286		90282	90287
Porcelain on glass Porcelaine sur verre	Black marble finish Fini marbre noir	1/2		91292		
	Statuario marble finish Fini marbre statuario	1/2		90292		
Starstone on glass Starstone sur verre	70 71	1/2	91286		91282	91287

* We do not recommend the use of painted glass with this table base to not hide its design./ Nous ne recommandons pas l'utilisation d'un verre peint avec cette base de table pour ne pas en cacher le design.



Wood colors available / Couleurs de bois disponibles
Distressed solid wood / Bois massif usé

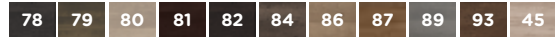

Non-distressed solid wood / Bois massif non usé



Note : Wood components ordered in Unfinished (85) must be finished. / Note : Les composantes de bois commandées dans le fini Non peint (85) doivent étre finies.

Kai 50707 FOR GLASS TABLETOP POUR DESSUS EN VERRE

PUB TABLE BASE
(counter height)

With solid wood accent

BASE DE TABLE PUB
(hauteur comptoir)

Avec accent en bois massif

in/po	W/L	D/P	H
Overall/Hors-tout	31 1/2	31 1/2	36

Kai 50807 FOR GLASS TABLETOP POUR DESSUS EN VERRE

PUB TABLE BASE
(bar height)

With solid wood accent

BASE DE TABLE PUB
(hauteur bar)

Avec accent en bois massif

in/po	W/L	D/P	H
Overall/Hors-tout	31 1/2	31 1/2	42

Shown with 90236 tabletop / Montrée avec le dessus de table 90236
Colors shown / Couleurs montrées : Cobrizo (75) / Rumcherry (41)

COMPATIBLE TABLETOPS DESSUS DE TABLE COMPATIBLES		Thickness Épaisseur in/po	36 dia.	39 dia.	42 dia.
Clear glass Verre clair	Clear Clair	1/2	90236		90242
Clear glass (beveled edge) Verre clair (chant biseau)	Clear Clair	3/8	90376		90375
Mat black glass Verre noir mat	Mat black Noir mat	1/2	90266		90262
Ultra white glass Verre ultra blanc	Ultra white Ultra blanc	1/2	90286		90282
Porcelain on glass Porcelaine sur verre	Black marble finish Fini marbre noir	1/2		91292	
	Statuario marble finish Fini marbre statuario	1/2		90292	
Starstone on glass Starstone sur verre	70 71	1/2	91286		91282

* We do not recommend the use of painted glass with this table base to not hide its design. / Nous ne recommandons pas l'utilisation d'un verre peint avec cette base de table pour ne pas en cacher le design.







Kai 50609 FOR WOOD TABLETOP POUR DESSUS EN BOIS

TABLE BASE
(table height)

BASE DE TABLE
(hauteur table)

in/po	W/L	D/P	H
Overall/Hors-tout	21 1/2	21 1/2	29 1/4

Shown with 90823 tabletop / Montrée avec le dessus de table 90823
Colors shown / Couleurs montrées : Oxidado (52) / Porter (44)

COMPATIBLE TABLETOPS DESSUS DE TABLE COMPATIBLES		Thickness Épaisseur in/po	36 dia. 	39 dia. 	42 dia. 	48 dia. 	36 x 36 
Solid wood (birch) Bois massif (merisier)	Distressed / Usé 78 79 80 81 82 84 86 87 89 93	1 1/16	90406		90412		90408
	Non-distressed / Non usé 39 41 42 43 44 46 47 48 49 96						
Solid wood (ash) Bois massif (frêne)	A1 A2 A3 A6 A7 A8 A9 AA AV	1 1/16	93406		93412		93408
Wood veneer (birch) Placage de bois (merisier)	39 41 42 43 44 46 48 49	1	90817		90823	90857	90827
Wood veneer (walnut) Placage de bois (noyer)	47 96	1	90818		90824	90858	90828
Thermo fused laminate (TFL) Panneau laminé	28 30 33 34	1		90539		*90548	90527

*Auburn (28) only / seulement.



Kai 50709 FOR WOOD TABLETOP POUR DESSUS EN BOIS

PUB TABLE BASE (counter height) **BASE DE TABLE PUB** (hauteur comptoir)

in/po	W/L	D/P	H
Overall/Hors-tout	21 1/2	21 1/2	35 1/4

Kai 50809 FOR WOOD TABLETOP POUR DESSUS EN BOIS

PUB TABLE BASE (bar height) **BASE DE TABLE PUB** (hauteur bar)

in/po	W/L	D/P	H
Overall/Hors-tout	21 1/2	21 1/2	41 1/4

Shown with 90817 tabletop / Montrée avec le dessus de table 90817
Colors shown / Couleurs montrées : Oxidado (52) / Porter (44)

COMPATIBLE TABLETOPS DESSUS DE TABLE COMPATIBLES		Thickness Épaisseur in/po	36 dia.	39 dia.	42 dia.	36 x 36
Solid wood (birch) Bois massif (merisier)	Distressed/ Usé	78 79 80 81 82 84 86 87 89 93	1 1/16	90406	90412	90408
	Non-distressed/ Non usé	39 41 42 43 44 46 47 48 49 96				
Solid wood (ash) Bois massif (frêne)	A1 A2 A3 A6 A7 A8 A9 AA AV	1 1/16	93406		93412	93408
Wood veneer (birch) Placage de bois (merisier)	39 41 42 43 44 46 48 49	1	90817		90823	90827
Wood veneer (walnut) Placage de bois (noyer)	47 96	1	90818		90824	90828
Thermo fused laminate (TFL) Panneau laminé	28 30 33 34	1		90539		90527



Lexington 50535

NEW
EXTENDABLE
TABLE BASE
(table height)

NOUVEAU
BASE DE TABLE
EXTENSIBLE
(hauteur table)

in/po	W/L	D/P	H
Overall/Hors-tout	27	66 7/8	28 7/8
Distance between legs at seat height Distance entre les pattes à la hauteur siège	—	41 1/4	18

Shown with 91493 tabletop / Montrée avec le dessus de table 91493
Colors shown / Couleurs montrées : Cobrizo (75) / Pine cone (96)

COMPATIBLE TABLETOPS DESSUS DE TABLE COMPATIBLES		Thickness Épaisseur in/po	38 x 72 + 15 (1)	38 x 72 + 15 (2)
Solid wood (birch) Bois massif (merisier)	Distressed / Usé	78 79 80 81 82 84 86 87 89 93	1 1/2	91490 91492
	Non-distressed / Non usé	39 41 42 43 44 46 47 48 49 96	1 1/2	91491 91493
Thermo fused laminate (TFL) Panneau laminé		28 30 33 34	1 5/8	91591 91592



Lidya 50583-PA FOR WOOD TABLETOP POUR DESSUS EN BOIS

SET OF 4 LEGS

JEU DE 4 PATTES

in/po	W/L	D/P	H
Overall / Hors-tout	3	1	28 1/2

Shown with 93485 tabletop / Montrée avec le dessus de table 93485
Colors shown / Couleurs montrées : Black coral / Noir corail (25)
Raccoon (A2)

COMPATIBLE TABLETOPS DESSUS DE TABLE COMPATIBLES		Thickness Épaisseur in/po	32 x 54	36 x 60	38 x 72	40 x 72	38 x 84	40 x 84	40 x 72+18 (2)	40 x 84+18 (2)
Solid wood (birch) Bois massif (merisier)	Distressed/Usé	1 1/2	90405*	90410* 91462		90487		90485	90483	90481
	78 79 80 81 82 84 86 87 89 93									
Solid wood (birch) with decorative bolts Bois massif (merisier) avec vis décoratives	Non-distressed/Non usé	1 1/2		91461		90486		90484	90482	90480
	39 41 42 43 44 46 47 48 49 96									
Solid wood (ash) Bois massif (frêne)	A1 A2 A3 A6	1 1/2				93487		93485	93483	93481
	A7 A8 A9 AA AV	1 1/16		93410 93460	93472		93484			
Wood veneer (birch) Placage de bois (merisier)	39 41 42 43 44 46 48 49	1	90845							
Wood veneer (walnut) Placage de bois (noyer)	47 96	1	90846							

* Thickness of 1 1/16 / Épaisseur de 1 1/16



Lidya 50587

FOR THERMO FUSED LAMINATE (TFL)
AND WOOD VENEER TABLETOPS
POUR DESSUS EN PANNEAU LAMINÉ
(TFL) ET PLACAGE DE BOIS

TABLE BASE

(table height)

BASE DE TABLE

(hauteur table)

in/po	W/L	D/P	H
Overall / <i>Hors-tout</i>	37 1/2	61 1/2	28 1/2
Distance between legs at seat height <i>Distance entre les pattes à la hauteur siège</i>	25 1/8	49 1/8	18

Shown with 90562 tabletop / *Montrée avec le dessus de table 90562*

Colors shown / *Couleurs montrées* : Titanium (56) / Almond (33)

COMPATIBLE TABLETOPS DESSUS DE TABLE COMPATIBLES		Thickness Épaisseur In/po	36 x 60
Wood veneer (birch) <i>Placage de bois (merisier)</i>	39 41 42 43 44 46 48 49	1	90860
Wood veneer (walnut) <i>Placage de bois (noyer)</i>	47 96	1	90861
Thermo fused laminate (TFL) <i>Panneau laminé</i>	28 30 33 34	1	90536
		1 5/8	90562



Lidya 50588

FOR THERMO FUSED LAMINATE (TFL)
AND WOOD VENEER TABLETOPS
POUR DESSUS EN PANNEAU LAMINÉ
(TFL) ET PLACAGE DE BOIS

TABLE BASE (table height)

BASE DE TABLE (hauteur table)

in/po	W/L	D/P	H
Overall / <i>Hors-tout</i>	40 5/8	71 5/8	28 1/2
Distance between legs at seat height <i>Distance entre les pattes à la hauteur siège</i>	28 1/4	59 1/4	18

Shown with 90563 tabletop / *Montrée avec le dessus de table 90563*
Colors shown / *Couleurs montrées* : Black coral / *Noir corail* (25) / Concrete (34)

COMPATIBLE TABLETOPS DESSUS DE TABLE COMPATIBLES		Thickness Épaisseur in/po	39 1/2 x 71 1/2	40 x 72
Wood veneer (birch) <i>Placage de bois (merisier)</i>	39 41 42 43 44 46 48 49	1	90863	
Wood veneer (walnut) <i>Placage de bois (noyer)</i>	47 96	1	90865	
Thermo fused laminate (TFL) <i>Panneau laminé</i>	28 30 33 34	1	90563	
		1 5/8		90586



Lidya 50589

FOR THERMO FUSED LAMINATE (TFL)
AND WOOD VENEER TABLETOPS
POUR DESSUS EN PANNEAU LAMINÉ
(TFL) ET PLACAGE DE BOIS

TABLE BASE (table height)

BASE DE TABLE (hauteur table)

in/po	W/L	D/P	H
Overall / <i>Hors-tout</i>	40 5/8	83 5/8	28 1/2
Distance between legs at seat height <i>Distance entre les pattes à la hauteur siège</i>	28 1/4	71 1/4	18

Shown with 90585 tabletop / *Montrée avec le dessus de table 90585*

Colors shown / *Couleurs montrées* : Black coral / *Noir corail* (25) / Basalt (30)

COMPATIBLE TABLETOPS DESSUS DE TABLE COMPATIBLES		Thickness Épaisseur in / po	39 1/2 x 83 1/2	40 x 84
Wood veneer (birch) <i>Placage de bois (merisier)</i>	39 41 42 43 44 46 48 49	1	90864	
Wood veneer (walnut) <i>Placage de bois (noyer)</i>	47 96	1	90866	
Thermo fused laminate (TFL) <i>Panneau laminé</i>	28 30 33 34	1	90564	
		1 5/8		90585



Lidya 50936 FOR GLASS TABLETOP
POUR DESSUS EN VERRE

TABLE BASE (table height) **BASE DE TABLE** (hauteur table)

in/po	W/L	D/P	H
Overall / Hors-tout	35 7/8	60	29 1/2
Distance between legs at seat height Distance entre les pattes à la hauteur siège	30 1/8	55 1/8	18

Shown with 90260 tabletop / Montrée avec le dessus de table 90260
Color shown / Couleur montrée : Black coral / Noir corail (25)

COMPATIBLE TABLETOPS DESSUS DE TABLE COMPATIBLES		Thickness Épaisseur In / po	36 x 60
Clear glass Verre clair	Clear Clair	1/2	90260
Mat black glass Verre noir mat	Mat black Noir mat	1/2	90270
Ultra white glass Verre ultra blanc	Ultra white Ultra blanc	1/2	90280
Porcelain on glass Porcelaine sur verre	Black marble finish Fini marbre noir	1/2	91290
	Statuario marble finish Fini marbre statuario	1/2	90290
Starstone on glass Starstone sur verre	70 71	1/2	91280



Lidya 50972

FOR GLASS TABLETOP
POUR DESSUS EN VERRE

TABLE BASE (table height)

BASE DE TABLE (hauteur table)

in / po	W/L	D/P	H
Overall / <i>Hors-tout</i>	35 7/8	68	29 1/2
Distance between legs at seat height <i>Distance entre les pattes à la hauteur siège</i>	30 1/8	63 1/8	18

Shown with 90271 tabletop / *Montrée avec le dessus de table 90271*
Color shown / *Couleur montrée* : Black coral / *Noir corail* (25)

COMPATIBLE TABLETOPS DESSUS DE TABLE COMPATIBLES			Thickness Épaisseur in / po	39 1/2 x 71 1/2
Clear glass <i>Verre clair</i>	Clear <i>Clair</i>		1/2	90271
Mat black glass <i>Verre noir mat</i>	Mat black <i>Noir mat</i>		1/2	90261
Ultra white glass <i>Verre ultra blanc</i>	Ultra white <i>Ultra blanc</i>		1/2	90281
Porcelain on glass <i>Porcelaine sur verre</i>	Black marble finish <i>Fini marbre noir</i>		1/2	91291
	Statuario marble finish <i>Fini marbre statuario</i>		1/2	90291
Starstone on glass <i>Starstone sur verre</i>	70 71		1/2	91281



Lidya 50984 FOR GLASS TABLETOP POUR DESSUS EN VERRE

TABLE BASE (table height)

BASE DE TABLE (hauteur table)

in/po	W/L	D/P	H
Overall / <i>Hors-tout</i>	35 7/8	80	29 1/2
Distance between legs at seat height <i>Distance entre les pattes à la hauteur siège</i>	30 1/8	75 1/8	18

Shown with 90273 tabletop / *Montrée avec le dessus de table 90273*
Color shown / *Couleur montrée* : Black coral / *Noir corail* (25)

COMPATIBLE TABLETOPS DESSUS DE TABLE COMPATIBLES		Thickness Épaisseur in/po	39 1/2 x 83 1/2
Clear glass <i>Verre clair</i>	Clear <i>Clair</i>	1/2	90273
Mat black glass <i>Verre noir mat</i>	Mat black <i>Noir mat</i>	1/2	90263
Ultra white glass <i>Verre ultra blanc</i>	Ultra white <i>Ultra blanc</i>	1/2	90283
Porcelain on glass <i>Porcelaine sur verre</i>	Black marble finish <i>Fini marbre noir</i>	1/2	91293
	Statuario marble finish <i>Fini marbre statuario</i>	1/2	90293
Starstone on glass <i>Starstone sur verre</i>	70 71	1/2	91283



Link 50554-36

PUB TABLE BASE (counter height)

BASE DE TABLE PUB (hauteur comptoir)

in/po	W/L	D/P	H
Overall/Hors-tout	21 1/2	21 1/2	35 1/2
Distance between legs at seat height Distance entre les pattes à la hauteur siège	9	9	26

Link 50554-42

PUB TABLE BASE (bar height)

BASE DE TABLE PUB (hauteur bar)

in/po	W/L	D/P	H
Overall/Hors-tout	23	23	41 1/2
Distance between legs at seat height Distance entre les pattes à la hauteur siège	9 3/4	9 3/4	30

Shown with 90262 tabletop / Montrée avec le dessus de table 90262
Colors shown / Couleurs montrées : Dayglam (53) / Black coral / Noir corail (25)

COMPATIBLE TABLETOPS DESSUS DE TABLE COMPATIBLES		Thickness Épaisseur in/po	36 dia.	39 dia.	42 dia.	36 x 36
Solid wood (birch) Bois massif (merisier)	Distressed / Usé	78 79 80 81 82 84 86 87 89 93	1 1/16	90406	90412	90408
	Non-distressed / Non usé	39 41 42 43 44 46 47 48 49 96				
Solid wood (ash) Bois massif (frêne)	A1 A2 A3 A6 A7 A8 A9 AA AV	1 1/16	93406		93412	93408
Wood veneer (birch) Placage de bois (merisier)	39 41 42 43 44 46 48 49	1	90817		90823	90827
Wood veneer (walnut) Placage de bois (noyer)	47 96	1	90818		90824	90828
Thermo fused laminate (TFL) Panneau laminé	28 30 33 34	1		90539		90527
Clear glass Verre clair	Clear Clair	1/2	90236		90242	90246
Clear glass (beveled edge) Verre clair (chant biseau)	Clear Clair	3/8	90376		90375	
Mat black glass Verre noir mat	Mat black Noir mat	1/2	90266		90262	90269
Ultra white glass Verre ultra blanc	Ultra white Ultra blanc	1/2	90286		90282	90289
Porcelain on glass Porcelaine sur verre	Black marble finish Fini marbre noir	1/2		91292		
	Statuario marble finish Fini marbre statuario	1/2		90292		
Starstone on glass Starstone sur verre	70 71	1/2	91286	91282		

Available in one or two metal finishes. If two metal finishes are desired, the first one will be for the legs and the second for the frame.
Disponibles en une ou deux couleurs de métal. Si deux couleurs sont désirées, la première sera pour les pattes, la deuxième pour le cadre.



Link 50555

TABLE BASE (table height)

BASE DE TABLE (hauteur table)

in/po	W/L	D/P	H
Overall/Hors-tout	25 1/2	25 1/2	29
Distance between legs at seat height Distance entre les pattes à la hauteur siège	14 1/2	14 1/2	18

Shown with 91287 tabletop / Montrée avec le dessus de table 91287
Colors shown / Couleurs montrées : Sun gold (27) / Lava (70)

COMPATIBLE TABLETOPS DESSUS DE TABLE COMPATIBLES		Thickness Épaisseur in/po	39 dia.	42 dia.	48 dia.	36 x 36
Solid wood (birch) Bois massif (merisier)	Distressed/Usé 78 79 80 81 82 84 86 87 89 93	11/16		90412		90408
	Non-distressed/Non usé 39 41 42 43 44 46 47 48 49 96					
Solid wood (ash) Bois massif (frêne)	A1 A2 A3 A6 A7 A8 A9 AA AV	11/16		93412		93408
Wood veneer (birch) Placage de bois (merisier)	39 41 42 43 44 46 48 49	1		90823	90857	90827
Wood veneer (walnut) Placage de bois (noyer)	47 96	1		90824	90858	90828
Thermo fused laminate (TFL) Panneau laminé	28 30 33 34	1	90539		*90548	90527
Clear glass Verre clair	Clear Clair	1/2		90242	90247	90246
Clear glass (Beveled edge) Verre clair (Chant biseau)	Clear Clair	3/8		90375	90378	
Mat black glass Verre noir mat	Mat black Noir mat	1/2		90262	90267	90269
Ultra white glass Verre ultra blanc	Ultra white Ultra blanc	1/2		90282	90287	90289
Porcelain on glass Porcelaine sur verre	Black marble finish Fini marbre noir	1/2	91292			
	Statuario marble finish Fini marbre statuario	1/2	90292			
Starstone on glass Starstone sur verre	70 71	1/2		91282	91287	

*28 Auburn only/seulement.

Available in one or two metal finishes. If two metal finishes are desired, the first one will be for the legs and the second for the frame.
Disponibles en une ou deux couleurs de métal. Si deux couleurs sont désirées, la première sera pour les pattes, la deuxième pour le cadre.



Link 50552 FOR WOOD TABLETOP POUR DESSUS EN BOIS

TABLE BASE

(table height - short version)

BASE DE TABLE

(hauteur table - version courte)

in/po	W/L	D/P	H
Overall/Hors-tout	31 3/4	62 3/4	29 1/4
Distance between legs at seat height Distance entre les pattes à la hauteur siège	26 1/4	57 1/4	18

Shown with 90487 tabletop / Montrée avec le dessus de table 90487

Colors shown / Couleurs montrées : Harley (51) / Sun gold (27) / Sand dust (86)

COMPATIBLE TABLETOPS DESSUS DE TABLE COMPATIBLES		Thickness Épaisseur in/po	39 1/2 x 71 1/2	40 x 72	40 x 72 + 18 (2)										
Solid wood (birch) Bois massif (merisier)	Distressed/Usé	1 1/2		90487	90483										
	<table border="1"> <tr><td>78</td><td>79</td><td>80</td><td>81</td><td>82</td></tr> <tr><td>84</td><td>86</td><td>87</td><td>89</td><td>93</td></tr> </table>	78	79	80	81	82	84	86	87	89	93				
78	79	80	81	82											
84	86	87	89	93											
Solid wood (birch) with decorative bolts Bois massif (merisier) avec vis décoratives	Non-distressed/Non usé	1 1/2		90486	90482										
	<table border="1"> <tr><td>39</td><td>41</td><td>42</td><td>43</td><td>44</td></tr> <tr><td>46</td><td>47</td><td>48</td><td>49</td><td>96</td></tr> </table>	39	41	42	43	44	46	47	48	49	96				
39	41	42	43	44											
46	47	48	49	96											
Solid wood (ash) Bois massif (frêne)	<table border="1"> <tr><td>A1</td><td>A2</td><td>A3</td><td>A6</td><td>A7</td></tr> <tr><td>A1</td><td>A2</td><td>A3</td><td>AV</td><td></td></tr> </table>	A1	A2	A3	A6	A7	A1	A2	A3	AV		1 1/2		93487	93483
	A1	A2	A3	A6	A7										
A1	A2	A3	AV												
Wood veneer (birch) Placage de bois (merisier)	<table border="1"> <tr><td>39</td><td>41</td><td>42</td><td>43</td><td>44</td></tr> <tr><td>46</td><td>48</td><td>49</td><td></td><td></td></tr> </table>	39	41	42	43	44	46	48	49			1	90863		
39	41	42	43	44											
46	48	49													
Wood veneer (walnut) Placage de bois (noyer)	<table border="1"> <tr><td>47</td><td>96</td><td></td><td></td><td></td></tr> </table>	47	96				1	90865							
47	96														
Thermo fused laminate (TFL) Panneau laminé	<table border="1"> <tr><td>28</td><td>30</td><td>33</td><td>34</td><td></td></tr> </table>	28	30	33	34		1	90563							
	28	30	33	34											
	1 5/8		90586												

Available in one or two metal finishes. If two metal finishes are desired, the first one will be for the legs and the second for the frame.
Disponibles en une ou deux couleurs de métal. Si deux couleurs sont désirées, la première sera pour les pattes, la deuxième pour le cadre.



Link 50553 FOR WOOD TABLETOP
POUR DESSUS EN BOIS

TABLE BASE
(table height - long version)

BASE DE TABLE
(hauteur table - version longue)

in/po	W/L	D/P	H
Overall/Hors-tout	31 3/4	74 3/4	29 1/4
Distance between legs at seat height Distance entre les pattes à la hauteur siège	26 1/4	69 1/4	18

Shown with 90485 tabletop/Montrée avec le dessus de table 90485
Colors shown/Couleurs montrées : Harley (51)/Sun gold (27)/Sand dust (86)

COMPATIBLE TABLETOPS DESSUS DE TABLE COMPATIBLES		Thickness Épaisseur in/po	39 1/2 x 83 1/2	40 x 84	40 x 84 + 18 (2)
Solid wood (birch) Bois massif (merisier)	Distressed/Usé	1 1/2		90485	90481
	78 79 80 81 82 84 86 87 89 93				
Solid wood (birch) with decorative bolts Bois massif (merisier) avec vis décoratives	Non-distressed/Non usé	1 1/2		90484	90480
	39 41 42 43 44 46 47 48 49 96				
Solid wood (ash) Bois massif (frêne)	A1 A2 A3 A6 A7 A1 A2 A3 AV	1 1/2		93485	93481
Wood veneer (birch) Placage de bois (merisier)	39 41 42 43 44 46 48 49	1	90864		
Wood veneer (walnut) Placage de bois (noyer)	47 96	1	90866		
Thermo fused laminate (TFL) Panneau laminé	28 30 33 34	1	90564		
		15/8		90585	

Available in one or two metal finishes. If two metal finishes are desired, the first one will be for the legs and the second for the frame.
Disponibles en une ou deux couleurs de métal. Si deux couleurs sont désirées, la première sera pour les pattes, la deuxième pour le cadre.



Link 50952 FOR GLASS TABLETOP POUR DESSUS EN VERRE

TABLE BASE
(table height - short version)

BASE DE TABLE
(hauteur table - version courte)

in/po	W/L	D/P	H
Overall / Hors-tout	31 3/4	62 3/4	29 5/8
Distance between legs at seat height <i>Distance entre les pattes à la hauteur siège</i>	26 1/4	57 1/4	18

Shown with 90271 tabletop / Montrée avec le dessus de table 90271
Colors shown / Couleurs montrées : Sun gold (27) / Pure (61)

COMPATIBLE TABLETOPS DESSUS DE TABLE COMPATIBLES		Thickness Épaisseur in/po	39 1/2 x 71 1/2
Clear glass <i>Verre clair</i>	Clear <i>Clair</i>	1/2	90271
Mat black glass <i>Verre noir mat</i>	Mat black <i>Noir mat</i>	1/2	90261
Ultra white glass <i>Verre ultra blanc</i>	Ultra white <i>Ultra blanc</i>	1/2	90281
Porcelain on glass <i>Porcelaine sur verre</i>	Black marble finish <i>Fini marbre noir</i>	1/2	91291
	Statuario marble finish <i>Fini marbre statuario</i>	1/2	90291
Starstone on glass <i>Starstone sur verre</i>	70 71	1/2	91281

Available in one or two metal finishes. If two metal finishes are desired, the first one will be for the legs and the second for the frame.
Disponibles en une ou deux couleurs de métal. Si deux couleurs sont désirées, la première sera pour les pattes, la deuxième pour le cadre.



Link 50953 FOR GLASS TABLETOP
POUR DESSUS EN VERRE

TABLE BASE
(table height - long version)

BASE DE TABLE
(hauteur table - version longue)

in/po	W/L	D/P	H
Overall / Hors-tout	31 3/4	74 3/4	29 5/8
Distance between legs at seat height <i>Distance entre les pattes à la hauteur siège</i>	26 1/4	69 1/4	18

Shown with 90273 tabletop / Montrée avec le dessus de table 90273
Colors shown / Couleurs montrées : Sun gold (27) / Pure (61)

COMPATIBLE TABLETOPS DESSUS DE TABLE COMPATIBLES		Thickness Épaisseur in/po	39 1/2 x 83 1/2
Clear glass <i>Verre clair</i>	Clear <i>Clair</i>	1/2	90273
Mat black glass <i>Verre noir mat</i>	Mat black <i>Noir mat</i>	1/2	90263
Ultra white glass <i>Verre ultra blanc</i>	Ultra white <i>Ultra blanc</i>	1/2	90283
Porcelain on glass <i>Porcelaine sur verre</i>	Black marble finish <i>Fini marbre noir</i>	1/2	91293
	Statuario marble finish <i>Fini marbre statuario</i>	1/2	90293
Starstone on glass <i>Starstone sur verre</i>	70 71	1/2	91283

Available in one or two metal finishes. If two metal finishes are desired, the first one will be for the legs and the second for the frame.
Disponibles en une ou deux couleurs de métal. Si deux couleurs sont désirées, la première sera pour les pattes, la deuxième pour le cadre.



Nexus 50524 EXTENDABLE TABLE TABLE EXTENSIBLE

TABLE BASE (table height)

BASE DE TABLE (hauteur table)

in/po	W/L	D/P	H
Overall/Hors-tout	30 3/4	54 3/4	29
Distance between legs at seat height Distance entre les pattes à la hauteur siège	20 3/8	44 3/8	18

Shown with 90891 tabletop/ Montrée avec le dessus de table 90891
Colors shown/ Couleurs montrées : Magnetite (24)/ Earl grey (48)



FEATURES

- Opens easily and effortlessly by one person
- Ball bearing slide mechanism
- Built-in leaf storage
- Smooth and durable lacquer finish

CARACTÉRISTIQUES

- Ouverture simple et sans effort par une seule personne
- Mécanisme de coulisses à billes synchronisées
- Rangement intégré pour les rallonges
- Finition laquée lisse et durable

COMPATIBLE TABLETOPS DESSUS DE TABLE COMPATIBLES		Thickness Épaisseur in/po	38 1/8 x 60+15	38 1/8 x 60+15 (2)
Solid wood (birch) Bois massif (merisier)	Distressed/ Usé	1 1/2	90465	90461
	78 79 80 81 82 84 86 87 89 93			
Solid wood (birch) with decorative bolts Bois massif (merisier) avec vis décoratives	Non-distressed/ Non usé	1 1/2	90464	90460
	39 41 42 43 44 46 47 48 49 96			
Solid wood (ash) Bois massif (frêne)	A1 A2 A3 A6 A7 A8 A9 AA AV	1 1/2	93465	93461
Wood veneer (birch) Placage de bois (merisier)	39 41 42 43 44 46 48 49	1		90891
Wood veneer (walnut) Placage de bois (noyer)	47 96	1		90892
Thermo fused laminate (TFL) Panneau laminé	28 30 33 34	1		90591



Nicholson 50667 FOR WOOD TABLETOP POUR DESSUS EN BOIS

TABLE BASE (table height)	BASE DE TABLE (hauteur table)		
in/po	W/L	D/P	H
Overall/Hors-tout	38 3/4	82 3/4	28 7/8
Distance between legs at seat height Distance entre les pattes à la hauteur siège	34 1/4	78 1/4	18

Shown with 93485 tabletop / Montrée avec le dessus de table 93485
Colors shown / Couleurs montrées : Cobrizo (75) / Raccoon (A2)

Nicholson 50667-36 FOR WOOD TABLETOP POUR DESSUS EN BOIS

PUB TABLE BASE (counter height)	BASE DE TABLE PUB (hauteur comptoir)		
in/po	W/L	D/P	H
Overall/Hors-tout	38 3/4	82 3/4	34 7/8
Distance between legs at seat height Distance entre les pattes à la hauteur siège	34 1/4	78 1/4	26

Nicholson 50667-42 FOR WOOD TABLETOP POUR DESSUS EN BOIS

PUB TABLE BASE (bar height)	BASE DE TABLE PUB (hauteur bar)		
in/po	W/L	D/P	H
Overall/Hors-tout	38 3/4	82 3/4	40 7/8
Distance between legs at seat height Distance entre les pattes à la hauteur siège	34 1/4	78 1/4	30

Shown with 93485 tabletop / Montrée avec le dessus de table 93485
Colors shown / Couleurs montrées : Cobrizo (75) / Raccoon (A2)

COMPATIBLE TABLETOPS DESSUS DE TABLE COMPATIBLES		Thickness Épaisseur in/po	39 1/2 x 83 1/2	40 x 84
Solid wood (birch) Bois massif (merisier)	Distressed / Usé 78 79 80 81 82 84 86 87 89 93	1 1/2		90485
Solid wood (birch) with decorative bolts Bois massif (merisier) avec vis décoratives	Non-distressed / Non usé 39 41 42 43 44 46 47 48 49 96	1 1/2		90484
Solid wood (ash) Bois massif (frêne)	A1 A2 A3 A6 A7 A8 A9 AA AV	1 1/2		93485
Wood veneer (birch) Placage de bois (merisier)	39 41 42 43 44 46 48 49	1	90864	
Wood veneer (walnut) Placage de bois (noyer)	47 96	1	90866	
Thermo fused laminate (TFL) Panneau laminé	28 30 33 34	1	90564	
		15/8		90585



Nicholson 50967 FOR GLASS TABLETOP POUR DESSUS EN VERRE

TABLE BASE (table height)	BASE DE TABLE (hauteur table)		
in/po	W/L	D/P	H
Overall/Hors-tout	38 3/4	82 3/4	29
Distance between legs at seat height <i>Distance entre les pattes à la hauteur siège</i>	34 1/4	78 1/4	18

Shown with 90293 tabletop/ *Montrée avec le dessus de table 90293*
Color shown/ *Couleur montrée* : Cobrizo (75)

Nicholson 50967-36 FOR GLASS TABLETOP POUR DESSUS EN VERRE

PUB TABLE BASE (counter height)	BASE DE TABLE PUB (hauteur comptoir)		
in/po	W/L	D/P	H
Overall/Hors-tout	38 3/4	82 3/4	35
Distance between legs at seat height <i>Distance entre les pattes à la hauteur siège</i>	34 1/4	78 1/4	26

Nicholson 50967-42 FOR GLASS TABLETOP POUR DESSUS EN VERRE

PUB TABLE BASE (bar height)	BASE DE TABLE PUB (hauteur bar)		
in/po	W/L	D/P	H
Overall/Hors-tout	38 3/4	82 3/4	41
Distance between legs at seat height <i>Distance entre les pattes à la hauteur siège</i>	34 1/4	78 1/4	30

Shown with 90293 tabletop/ *Montrée avec le dessus de table 90293*
Color shown/ *Couleur montrée* : Cobrizo (75)

COMPATIBLE TABLETOPS DESSUS DE TABLE COMPATIBLES		Thickness <i>Épaisseur</i> in/po	39 1/2 x 83 1/2
Clear glass <i>Verre clair</i>	Clear <i>Clair</i>	1/2	90273
Mat black glass <i>Verre noir mat</i>	Mat black <i>Noir mat</i>	1/2	90263
Ultra white glass <i>Verre ultra blanc</i>	Ultra white <i>Ultra blanc</i>	1/2	90283
Porcelain on glass <i>Porcelaine sur verre</i>	Black marble finish <i>Fini marbre noir</i>	1/2	91293
	Statuario marble finish <i>Fini marbre statuario</i>	1/2	90293
Starstone on glass <i>Starstone sur verre</i>	70 71	1/2	91283



Norcross 50563

TABLE BASE
(table height)

BASE DE TABLE
(hauteur table)

in/po	W/L	D/P	H
Overall/Hors-tout	25 1/2	25 1/2	29

Shown with 90412 tabletop / Montrée avec le dessus de table 90412
Colors shown / Couleurs montrées : Oxidado (52) / Sand dust (86)

COMPATIBLE TABLETOPS DESSUS DE TABLE COMPATIBLES		Thickness Épaisseur in / po	36 dia.	39 dia.	42 dia.	48 dia.	36 x 36
Solid wood (birch) <i>Bois massif (merisier)</i>	Distressed/ Usé	78 79 80 81 82 84 86 87 89 93	1 1/16	90406	90412		90408
	Non-distressed/ Non usé	39 41 42 43 44 46 47 48 49 96					
Solid wood (ash) <i>Bois massif (frêne)</i>		A1 A2 A3 A6 A7 A8 A9 AA AV	1 1/16	93406	93412		93408
Wood veneer (birch) <i>Placage de bois (merisier)</i>		39 41 42 43 44 46 48 49	1	90817	90823	90857	90827
Wood veneer (walnut) <i>Placage de bois (noyer)</i>		47 96	1	90818	90824	90858	90828
Thermo fused laminate (TFL) <i>Panneau laminé</i>		28 30 33 34	1		90539	*90548	90527
Clear glass <i>Verre clair</i>	Clear <i>Clair</i>		1/2	90236	90242	90247	90246
Clear glass (beveled edge) <i>Verre clair (chant biseau)</i>	Clear <i>Clair</i>		3/8	90376	90375	90378	
Mat black glass <i>Verre noir mat</i>	Mat black <i>Noir mat</i>		1/2	90266	90262	90267	90269
Ultra white glass <i>Verre ultra blanc</i>	Ultra white <i>Ultra blanc</i>		1/2	90286	90282	90287	90289
Porcelain on glass <i>Porcelaine sur verre</i>	Black marble finish <i>Fini marbre noir</i>		1/2		91292		
	Statuario marble finish <i>Fini marbre statuario</i>		1/2		90292		
Starstone on glass <i>Starstone sur verre</i>		70 71	1/2	91286	91282	91287	

*28 Auburn only/ seulement.



Norcross 50563-36

PUB TABLE BASE
(counter height)

BASE DE TABLE PUB
(hauteur comptoir)

in/po	W/L	D/P	H
Overall/Hors-tout	22 7/8	22 1/8	34 7/8





Norcross 50563-42

PUB TABLE BASE
(bar height)

BASE DE TABLE PUB
(hauteur bar)

in/po	W/L	D/P	H
Overall/Hors-tout	22 1/8	22 1/8	40 7/8

Shown with 90412 tabletop / Montrée avec le dessus de table 90412
Colors shown / Couleurs montrées : Harley (51)/Toasty (87)

COMPATIBLE TABLETOPS DESSUS DE TABLE COMPATIBLES		Thickness Épaisseur in / po	36 dia. 	39 dia. 	42 dia. 	36 x 36 
Solid wood (birch) <i>Bois massif (merisier)</i>	Distressed/ Usé 78 79 80 81 82 84 86 87 89 93	1 1/16	90406		90412	90408
	Non-distressed/ Non usé 39 41 42 43 44 46 47 48 49 96					
Solid wood (ash) <i>Bois massif (frêne)</i>	A1 A2 A3 A6 A7 A8 A9 AA AV	1 1/16	93406		93412	93408
Wood veneer (birch) <i>Placage de bois (merisier)</i>	39 41 42 43 44 46 48 49	1	90817		90823	90827
Wood veneer (walnut) <i>Placage de bois (noyer)</i>	47 96	1	90818		90824	90828
Thermo fused laminate (TFL) <i>Panneau laminé</i>	28 30 33 34	1		90539		90527
Clear glass <i>Verre clair</i>	Clear <i>Clair</i>	1/2	90236		90242	90246
Clear glass (beveled edge) <i>Verre clair (chant biseau)</i>	Clear <i>Clair</i>	3/8	90376		90375	
Mat black glass <i>Verre noir mat</i>	Mat black <i>Noir mat</i>	1/2	90266		90262	90269
Ultra white glass <i>Verre ultra blanc</i>	Ultra white <i>Ultra blanc</i>	1/2	90286		90282	90289
Porcelain on glass <i>Porcelaine sur verre</i>	Black marble finish <i>Fini marbre noir</i>	1/2		91292		
	Statuario marble finish <i>Fini marbre statuario</i>	1/2		90292		
Starstone on glass <i>Starstone sur verre</i>	70 71	1/2	91286		91282	



Octavia 50576

TABLE BASE (table height)

BASE DE TABLE (hauteur table)

in/po	W/L	D/P	H
Overall/Hors-tout	27 7/8	39 3/4	29 3/8
Distance between legs at seat height Distance entre les pattes à la hauteur siège	—	27 3/4	18

Shown with 91462 tabletop / Montrée avec le dessus de table 91462
Colors shown / Couleurs montrées : Black coral / Noir corail (25) /
Verdos (79)

COMPATIBLE TABLETOPS DESSUS DE TABLE COMPATIBLES		Thickness Épaisseur in/po	36 x 60
Solid wood (birch) Bois massif (merisier)	Distressed / Usé 78 79 80 81 82 84 86 87 89 93	1 1/2	90410* 91462
Solid wood (birch) with decorative bolts Bois massif (merisier) avec vis décoratives	Non-distressed / Non usé 39 41 42 43 44 46 47 48 49 96	1 1/2	91461
Solid wood (ash) Bois massif (frêne)	A1 A2 A3 A6 A7 A8 A9 AA AV	1 1/16	93410 93460
Wood veneer (birch) Placage de bois (merisier)	39 41 42 43 44 46 48 49	1	90860
Wood veneer (walnut) Placage de bois (noyer)	47 96	1	90861
Thermo fused laminate (TFL) Panneau laminé	28 30 33 34	1	90536
		15/8	90562

* Thickness of 1 1/16 / Épaisseur de 1 1/16



Octavia 50577

TABLE BASE

BASE DE TABLE

in/po	W/L	D/P	H
Overall/Hors-tout	27 7/8	48 1/2	29 3/8
Distance between legs at seat height Distance entre les pattes à la hauteur siège	—	36 1/4	18

Shown with 90586 tabletop / Montrée avec le dessus de table 90586

Colors shown / Couleurs montrées : Black coral / Noir corail (25) / Auburn (28)

COMPATIBLE TABLETOPS DESSUS DE TABLE COMPATIBLES		Thickness Épaisseur in/po	38 x 72	39 1/2 x 71 1/2	40 x 72	40 x 72+18 (2)										
Solid wood (birch) Bois massif (merisier)	Distressed/Usé	1 1/2			90487	90483										
	<table border="1"> <tr><td>78</td><td>79</td><td>80</td><td>81</td><td>82</td></tr> <tr><td>84</td><td>86</td><td>87</td><td>89</td><td>93</td></tr> </table>		78	79	80	81	82	84	86	87	89	93				
78	79	80	81	82												
84	86	87	89	93												
Solid wood (birch) with decorative bolts Bois massif (merisier) avec vis décoratives	Non-distressed/Non usé	1 1/2			90486	90482										
	<table border="1"> <tr><td>39</td><td>41</td><td>42</td><td>43</td><td>44</td></tr> <tr><td>46</td><td>47</td><td>48</td><td>49</td><td>96</td></tr> </table>		39	41	42	43	44	46	47	48	49	96				
39	41	42	43	44												
46	47	48	49	96												
Solid wood (ash) Bois massif (frêne)	<table border="1"> <tr><td>A1</td><td>A2</td><td>A3</td><td>A6</td><td>A7</td></tr> <tr><td>A1</td><td>A2</td><td>A3</td><td>AV</td><td></td></tr> </table>	A1	A2	A3	A6	A7	A1	A2	A3	AV		1 1/2			93487	93483
	A1	A2	A3	A6	A7											
A1	A2	A3	AV													
		1 1/16	93472													
Wood veneer (birch) Placage de bois (merisier)	<table border="1"> <tr><td>39</td><td>41</td><td>42</td><td>43</td><td>44</td></tr> <tr><td>46</td><td>48</td><td>49</td><td></td><td></td></tr> </table>	39	41	42	43	44	46	48	49			1		90863		
39	41	42	43	44												
46	48	49														
Wood veneer (walnut) Placage de bois (noyer)	<table border="1"> <tr><td>47</td><td>96</td><td></td><td></td><td></td></tr> </table>	47	96				1		90865							
47	96															
Thermo fused laminate (TFL) Panneau laminé	<table border="1"> <tr><td>28</td><td>30</td><td>33</td><td>34</td><td></td></tr> </table>	28	30	33	34		1		90563							
	28	30	33	34												
		15/8			90586											



Octavia 50578

TABLE BASE (table height)

BASE DE TABLE (hauteur table)

in/po	W/L	D/P	H
Overall/Hors-tout	27 7/8	60 5/8	29 3/8
Distance between legs at seat height Distance entre les pattes à la hauteur siège	—	48 1/4	18

Shown with 93485 tabletop / Montrée avec le dessus de table 93485
Colors shown / Couleurs montrées : Black coral / Noir corail (25) /
Verduzzu (AV)

COMPATIBLE TABLETOPS DESSUS DE TABLE COMPATIBLES		Thickness Épaisseur in/po	38 x 84	39 1/2 x 83 1/2	40 x 84	40 x 84 + 18 (2)
Solid wood (birch) Bois massif (merisier)	Distressed/Usé	1 1/2			90485	90481
	78 79 80 81 82 84 86 87 89 93					
Solid wood (birch) with decorative bolts Bois massif (merisier) avec vis décoratives	Non-distressed/Non usé	1 1/2			90484	90480
	39 41 42 43 44 46 47 48 49 96					
Solid wood (ash) Bois massif (frêne)	A1 A2 A3 A6 A7	1 1/2			93485	93481
	A1 A2 A3 AV	1 1/16	93484			
Wood veneer (birch) Placage de bois (merisier)	39 41 42 43 44 46 48 49	1		90864		
	47 96	1		90866		
Thermo fused laminate (TFL) Panneau laminé	28 30 33 34	1		90564		
		15/8			90585	



Parade 50559

TABLE BASE (table height)

BASE DE TABLE (hauteur table)

in/ po	W/L	D/P	H
Overall/ Hors-tout	27 3/4	37 1/4	29 1/4
Distance between legs at seat height Distance entre les pattes à la hauteur siège	—	30 1/8	18

Shown with 91462 tabletop/ Montrée avec le dessus de table 91462
Colors shown/ Couleurs montrées : Black coral/ Noir corail (25)
Cashew (46)

COMPATIBLE TABLETOPS DESSUS DE TABLE COMPATIBLES		Thickness Épaisseur in/ po	36 x 60
Solid wood (birch) Bois massif (merisier)	Distressed/ Usé 78 79 80 81 82 84 86 87 89 93	1 1/2	90410* 91462
	Non-distressed/ Non usé 39 41 42 43 44 46 47 48 49 96	1 1/2	91461
Solid wood (ash) Bois massif (frêne)	A1 A2 A3 A6 A7 A8 A9 AA AV	1 1/16	93410 93460
Wood veneer (birch) Placage de bois (merisier)	39 41 42 43 44 46 48 49	1	90860
Wood veneer (walnut) Placage de bois (noyer)	47 96	1	90861
Thermo fused laminate (TFL) Panneau laminé	28 30 33 34	1	90536
		15/8	90562

* Thickness of 1 1/16/ Épaisseur de 1 1/16



Parade 50566

TABLE BASE (table height)

BASE DE TABLE (hauteur table)

in/po	W/L	D/P	H
Overall/Hors-tout	31	49 3/4	29 1/4
Distance between legs at seat height Distance entre les pattes à la hauteur siège	—	42 3/8	18

Shown with 90486 tabletop / Montrée avec le dessus de table 90486
Colors shown / Couleurs montrées : Harley (51) / Sand dust (86)

Parade 50566-36

PUB TABLE BASE (counter height)

BASE DE TABLE PUB (hauteur comptoir)

in/po	W/L	D/P	H
Overall/Hors-tout	30 7/8	49 3/4	35 1/16
Distance between legs at seat height Distance entre les pattes à la hauteur siège	—	42 3/8	26

Parade 50566-42

PUB TABLE BASE (bar height)

BASE DE TABLE PUB (hauteur bar)

in/po	W/L	D/P	H
Overall/Hors-tout	30 7/8	49 3/4	41 1/16
Distance between legs at seat height Distance entre les pattes à la hauteur siège	—	42 3/8	30

Shown with 90486 tabletop / Montrée avec le dessus de table 90486
Colors shown / Couleurs montrées : Metallo (57) / Stone dust (89)

COMPATIBLE TABLETOPS DESSUS DE TABLE COMPATIBLES		Thickness Épaisseur in/po	39 1/2 x 71 1/2	40 x 72	40 x 72 + 18 (2)
Solid wood (birch) Bois massif (merisier)	Distressed/Usé	1 1/2		90487	90483
	78 79 80 81 82 84 86 87 89 93				
Solid wood (birch) with decorative bolts Bois massif (merisier) avec vis décoratives	Non-distressed/Non usé	1 1/2		90486	90482
	39 41 42 43 44 46 47 48 49 96				
Solid wood (ash) Bois massif (frêne)	A1 A2 A3 A6 A7 A1 A2 A3 AV	1 1/2		93487	93483
Wood veneer (birch) Placage de bois (merisier)	39 41 42 43 44 46 48 49	1	90863		
Wood veneer (walnut) Placage de bois (noyer)	47 96	1	90865		
Thermo fused laminate (TFL) Panneau laminé	28 30 33 34	1	90563		
		15/8		90586	



Parade 50565

TABLE BASE (table height)

BASE DE TABLE (hauteur table)

in/po	W/L	D/P	H
Overall/Hors-tout	31	61 3/4	29 1/4
Distance between legs at seat height Distance entre les pattes à la hauteur siège	—	54 3/8	18

Shown with 90484 tabletop / Montrée avec le dessus de table 90484
Colors shown / Couleurs montrées : Harley (51) / Sand dust (86)

Parade 50565-36

PUB TABLE BASE (counter height)

BASE DE TABLE PUB (hauteur comptoir)

in/po	W/L	D/P	H
Overall/Hors-tout	30 7/8	61 3/4	35 1/16
Distance between legs at seat height Distance entre les pattes à la hauteur siège	—	54 3/8	26

Parade 50565-42

PUB TABLE BASE (bar height)

BASE DE TABLE PUB (hauteur bar)

in/po	W/L	D/P	H
Overall/Hors-tout	30 7/8	61 3/4	41 1/16
Distance between legs at seat height Distance entre les pattes à la hauteur siège	—	54 3/8	30

Shown with 90484 tabletop / Montrée avec le dessus de table 90484
Colors shown / Couleurs montrées : Metallo (57) / Stone dust (89)

COMPATIBLE TABLETOPS DESSUS DE TABLE COMPATIBLES		Thickness Épaisseur in/po	39 1/2 x 83 1/2	40 x 84	40 x 84 + 18 (2)
Solid wood (birch) Bois massif (merisier)	Distressed/Usé	1 1/2		90485	90481
	Non-distressed/Non usé	1 1/2		90484	90480
Solid wood (ash) Bois massif (frêne)		1 1/2		93485	93481
		1	90864		
Wood veneer (birch) Placage de bois (merisier)		1	90866		
		1	90564		
Wood veneer (walnut) Placage de bois (noyer)		15/8		90585	



Ricard 50664 FOR WOOD TABLETOP POUR DESSUS EN BOIS

TABLE BASE (table height)

BASE DE TABLE (hauteur table)

in/po	W/L	D/P	H
Overall/Hors-tout	35 1/4	59 1/4	28 7/8
Distance between legs at seat height Distance entre les pattes à la hauteur siège	31 3/4	55 3/4	18

Shown with 90861 tabletop/ Montrée avec le dessus de table 90861
Colors shown/ Couleurs montrées : Magnetite (24)/ Tiramisu (47)

Ricard 50664-36 FOR WOOD TABLETOP POUR DESSUS EN BOIS

PUB TABLE BASE (counter height)

BASE DE TABLE PUB (hauteur comptoir)

in/po	W/L	D/P	H
Overall/Hors-tout	35 1/4	59 1/4	34 7/8
Distance between legs at seat height Distance entre les pattes à la hauteur siège	31 3/4	55 3/4	26

Ricard 50664-42 FOR WOOD TABLETOP POUR DESSUS EN BOIS

PUB TABLE BASE (bar height)

BASE DE TABLE PUB (hauteur bar)

in/po	W/L	D/P	H
Overall/Hors-tout	35 1/4	59 1/4	40 7/8
Distance between legs at seat height Distance entre les pattes à la hauteur siège	31 3/4	55 3/4	30

Shown with 90861 tabletop/ Montrée avec le dessus de table 90861
Colors shown/ Couleurs montrées : Magnetite (24)/ Tiramisu (47)

COMPATIBLE TABLETOPS DESSUS DE TABLE COMPATIBLES		Thickness Épaisseur in/po	36 x 60
Solid wood (birch) Bois massif (merisier)	Distressed/ Usé	78 79 80 81 82 84 86 87 89 93	1 1/2 90410* 91462
	Non-distressed/ Non usé	39 41 42 43 44 46 47 48 49 96	1 1/2 91461
Solid wood (ash) Bois massif (frêne)	A1 A2 A3 A6 A7 A8 A9 AA AV	1 1/16	93410
Wood veneer (birch) Placage de bois (merisier)	39 41 42 43 44 46 48 49	1	90860
Wood veneer (walnut) Placage de bois (noyer)	47 96	1	90861
Thermo fused laminate (TFL) Panneau laminé	28 30 33 34	1	90536
		1 5/8	90562

* Thickness of 1 1/16/ Épaisseur de 11/16



Ricard 50964

FOR GLASS TABLETOP
POUR DESSUS EN VERRE

TABLE BASE (table height)

BASE DE TABLE (hauteur table)

in/po	W/L	D/P	H
Overall/Hors-tout	35 1/4	59 1/4	29
Distance between legs at seat height Distance entre les pattes à la hauteur siège	31 3/4	55 3/4	18

Shown with 90260 tabletop / Montrée avec le dessus de table 90260
Color shown / Couleur montrée : Magnetite (24)

Ricard 50964-36

FOR GLASS TABLETOP
POUR DESSUS EN VERRE

PUB TABLE BASE (counter height)

BASE DE TABLE PUB (hauteur comptoir)

in/po	W/L	D/P	H
Overall/Hors-tout	35 1/4	59 1/4	35
Distance between legs at seat height Distance entre les pattes à la hauteur siège	31 3/4	55 3/4	26

Ricard 50964-42

FOR GLASS TABLETOP
POUR DESSUS EN VERRE

PUB TABLE BASE (bar height)

BASE DE TABLE PUB (hauteur bar)

in/po	W/L	D/P	H
Overall/Hors-tout	35 1/4	59 1/4	41
Distance between legs at seat height Distance entre les pattes à la hauteur siège	31 3/4	55 3/4	30

Shown with 90260 tabletop / Montrée avec le dessus de table 90260
Color shown / Couleur montrée : Magnetite (24)

COMPATIBLE TABLETOPS DESSUS DE TABLE COMPATIBLES		Thickness Épaisseur in/po	36 x 60
Clear glass Verre clair	Clear Clair	1/2	90260
Mat black glass Verre noir mat	Mat black Noir mat	1/2	90270
Ultra white glass Verre ultra blanc	Ultra white Ultra blanc	1/2	90280
Porcelain on glass Porcelaine sur verre	Black marble finish Fini marbre noir	1/2	91290
	Statuario marble finish Fini marbre statuario	1/2	90290
Starstone on glass Starstone sur verre	70 71	1/2	91280



Richview 50531 FOR TABLETOP WITH BUTTERFLY LEAF
 POUR DESSUS AVEC RALLONGE PAPILLON

TABLE BASE
 (table height)

BASE DE TABLE
 (hauteur table)

in/po	W/L	D/P	H
Overall/Hors-tout	28 3/8	54 7/8	28 3/4
Distance between legs at seat height Distance entre les pattes à la hauteur siège	20 3/4	44 3/4	18

Shown with 90896 tabletop/Montrée avec le dessus de table 90896
 Colors shown/Couleurs montrées : Titanium (56)/Tiramisu (47)

FEATURES

- Opens easily and effortlessly by one person
- Ball bearing slide mechanism
- Built-in leaf storage

CARACTÉRISTIQUES

- Ouverture simple et sans effort par une seule personne
- Mécanisme de coulisses à billes synchronisées
- Rangement intégré pour les rallonges

COMPATIBLE TABLETOPS DESSUS DE TABLE COMPATIBLES		Thickness Épaisseur in/po	Oval/Ovale 38 x 72+24	Radius corners Coins arrondis 38 x 72+24	Square corners Coins carrés 38 x 72+24
Wood veneer (birch) Placage de bois (merisier)	41 42 43 44 46 48 49	1	90895	90893	90888
Wood veneer (walnut) Placage de bois (noyer)	47 96	1	90896	90894	90889
Thermo fused laminate (TFL) Panneau laminé	30 33 34	1	90595	90594	90592



Southcross 50562

TABLE BASE
(table height - short version)

BASE DE TABLE
(hauteur table - version courte)

in/po	W/L	D/P	H
Overall/Hors-tout	32 3/8	53	29 1/8
Distance between legs at seat height Distance entre les pattes à la hauteur siège	—	42 3/8	18



For optimal comfort, we recommend the use of this table with a maximum of 4 chairs (2 chairs on each long side of the table).
Pour un confort optimal, nous recommandons d'utiliser cette table avec un maximum de 4 chaises (2 sur chaque bord long de la table).

Shown with 90410 tabletop / Montrée avec le dessus de table 90410
Colors shown / Couleurs montrées : Harley (51) / Stone dust (89)

COMPATIBLE TABLETOPS DESSUS DE TABLE COMPATIBLES		Thickness Épaisseur in/po	36 x 60	39 1/2 x 71 1/2	40 x 72	40 x 72+18 (2)										
Solid wood (birch) Bois massif (merisier)	Distressed/Usé	1 1/2	90410* 91462		90487	90483										
	<table border="1"> <tr><td>78</td><td>79</td><td>80</td><td>81</td><td>82</td></tr> <tr><td>84</td><td>86</td><td>87</td><td>89</td><td>93</td></tr> </table>	78	79	80	81	82	84	86	87	89	93					
78	79	80	81	82												
84	86	87	89	93												
Solid wood (birch) with decorative bolts Bois massif (merisier) avec vis décoratives	Non-distressed/Non usé	1 1/2	91461		90486	90482										
	<table border="1"> <tr><td>39</td><td>41</td><td>42</td><td>43</td><td>44</td></tr> <tr><td>46</td><td>47</td><td>48</td><td>49</td><td>96</td></tr> </table>	39	41	42	43	44	46	47	48	49	96					
39	41	42	43	44												
46	47	48	49	96												
Solid wood (ash) Bois massif (frêne)	<table border="1"> <tr><td>A1</td><td>A2</td><td>A3</td><td>A6</td><td>A7</td></tr> <tr><td>A1</td><td>A2</td><td>A3</td><td>AV</td><td></td></tr> </table>	A1	A2	A3	A6	A7	A1	A2	A3	AV		1 1/2	93410*		93487	93483
	A1	A2	A3	A6	A7											
A1	A2	A3	AV													
<table border="1"> <tr><td>39</td><td>41</td><td>42</td><td>43</td><td>44</td></tr> <tr><td>46</td><td>48</td><td>49</td><td></td><td></td></tr> </table>	39	41	42	43	44	46	48	49			1	90860	90863			
39	41	42	43	44												
46	48	49														
Wood veneer (walnut) Placage de bois (noyer)	<table border="1"> <tr><td>47</td><td>96</td></tr> </table>	47	96	1	90861	90865										
47	96															
Thermo fused laminate (TFL) Panneau laminé	<table border="1"> <tr><td>28</td><td>30</td><td>33</td><td>34</td></tr> </table>	28	30	33	34	1	90536	90563								
	28	30	33	34												
	1 5/8	90562		90586												

*Thickness of 1 1/16" / Épaisseur de 1 1/16"



Southcross 50567

TABLE BASE (table height - long version)	BASE DE TABLE (hauteur table - version longue)		
in/po	W/L	D/P	H
Overall/Hors-tout	32 3/8	63	29 1/8
Distance between legs at seat height Distance entre les pattes à la hauteur siège	—	52 3/8	18

Shown with 90484 tabletop / Montrée avec le dessus de table 90484
 Colors shown / Couleurs montrées : Harley (51)/Stone dust (89)

COMPATIBLE TABLETOPS DESSUS DE TABLE COMPATIBLES		Thickness Épaisseur in/po	39 1/2 x 83 1/2	40 x 84	40 x 84 + 18 (2)
Solid wood (birch) Bois massif (merisier)	Distressed/Usé	78 79 80 81 82	1 1/2	90485	90481
	Solid wood (birch) with decorative bolts Bois massif (merisier) avec vis décoratives	84 86 87 89 93 Non-distressed/Non usé 39 41 42 43 44 46 47 48 49 96	1 1/2	90484	90480
Solid wood (ash) Bois massif (frêne)		A1 A2 A3 A6 A7 A1 A2 A3 AV	1 1/2	93485	93481
	Wood veneer (birch) Placage de bois (merisier)	39 41 42 43 44 46 48 49	1	90864	
Wood veneer (walnut) Placage de bois (noyer)	47 96	1	90866		
Thermo fused laminate (TFL) Panneau laminé		28 30 33 34	1	90564	
			15/8	90585	



Tacoma 50516 EXTENDABLE TABLE TABLE EXTENSIBLE

TABLE BASE (table height)

BASE DE TABLE (hauteur table)

in/po	W/L	D/P	H
Overall/Hors-tout	32 3/8	57	28 3/8
Distance between legs at seat height Distance entre les pattes à la hauteur siège	25 3/8	44 7/8	18

Shown with 90460 tabletop / Montrée avec le dessus de table 90460
Colors shown / Couleurs montrées : Harley (51) / Sand dust (86)



FEATURES

- Opens easily and effortlessly by one person
- Ball bearing slide mechanism
- Built-in leaf storage

CARACTÉRISTIQUES

- Ouverture simple et sans effort par une seule personne
- Mécanisme de coulisses à billes synchronisées
- Rangement intégré pour les rallonges

COMPATIBLE TABLETOPS DESSUS DE TABLE COMPATIBLES		Thickness Épaisseur in/po	38 1/8 x 60+15	38 1/8 x 60+15 (2)
Solid wood (birch) Bois massif (merisier)	Distressed/Usé	1 1/2	90465	90461
	78 79 80 81 82 84 86 87 89 93			
Solid wood (birch) with decorative bolts Bois massif (merisier) avec vis décoratives	Non-distressed/Non usé	1 1/2	90464	90460
	39 41 42 43 44 46 47 48 49 96			
Solid wood (ash) Bois massif (frêne)	A1 A2 A3 A6 A7 A1 A2 A3 AV	1 1/2	93465	93461
Wood veneer (birch) Placage de bois (merisier)	39 41 42 43 44 46 48 49	1		90891
Wood veneer (walnut) Placage de bois (noyer)	47 96	1		90892
Thermo fused laminate (TFL) Panneau laminé	28 30 33 34	1		90591



Tayra 50596 FOR WOOD TABLETOP POUR DESSUS EN BOIS

TABLE BASE (table height)

BASE DE TABLE (hauteur table)

in/po	W/L	D/P	H
Overall/Hors-tout	24 3/4	41	29
Distance between legs at seat height Distance entre les pattes à la hauteur siège	—	30	18

Shown with 90860 tabletop / Montrée avec le dessus de table 90860
Colors shown / Couleurs montrées : Black coral / Noir corail (25) /
Cashew (46)

COMPATIBLE TABLETOPS DESSUS DE TABLE COMPATIBLES		Thickness Épaisseur in/po	36 x 60
Solid wood (birch) Bois massif (merisier)	Distressed / Usé 78 79 80 81 82 84 86 87 89 93	1 1/2	91410* 91462
	Non-distressed / Non usé 39 41 42 43 44 46 47 48 49 96	1 1/2	91461
Solid wood (ash) Bois massif (frêne)	A1 A2 A3 A6 A7 A8 A9 AA AV	1 1/16	93410 93460
Wood veneer (birch) Placage de bois (merisier)	39 41 42 43 44 46 48 49	1	90860
Wood veneer (walnut) Placage de bois (noyer)	47 96	1	90861

* Thickness of 1 1/16 / Épaisseur de 1 1/16



Tayra 50597 FOR WOOD TABLETOP POUR DESSUS EN BOIS

TABLE BASE (table height)

BASE DE TABLE (hauteur table)

in/po	W/L	D/P	H
Overall / <i>Hors-tout</i>	24 3/4	49 1/2	29
Distance between legs at seat height <i>Distance entre les pattes à la hauteur siège</i>	—	38 1/2	18

Shown with 93487 tabletop / Montrée avec le dessus de table 93487
Colors shown / *Couleurs montrées* : Black coral / *Noir corail* (25) /
Anthracite (A6)

COMPATIBLE TABLETOPS <i>DESSUS DE TABLE COMPATIBLES</i>		Thickness <i>Épaisseur</i> in/po	38 x 72	39 1/2 x 71 1/2	40 x 72	40 x 72+18 (2)
Solid wood (birch) <i>Bois massif (merisier)</i>	Distressed / <i>Usé</i>	1 1/2			90487	90483
	78 79 80 81 82 84 86 87 89 93					
Solid wood (birch) with decorative bolts <i>Bois massif (merisier) avec vis décoratives</i>	Non-distressed / <i>Non usé</i>	1 1/2			90486	90482
	39 41 42 43 44 46 47 48 49 96					
Solid wood (ash) <i>Bois massif (frêne)</i>	A1 A2 A3 A6 A7	1 1/2			93487	93483
	A1 A2 A3 AV	1 1/16	93472			
Wood veneer (birch) <i>Placage de bois (merisier)</i>	39 41 42 43 44 46 48 49	1		90863		
	47 96	1		90865		



Tayra 50598 FOR WOOD TABLETOP POUR DESSUS EN BOIS

TABLE BASE (table height)

BASE DE TABLE (hauteur table)

in/po	W/L	D/P	H
Overall/Hors-tout	24 3/4	61 1/2	29
Distance between legs at seat height <i>Distance entre les pattes à la hauteur siège</i>	—	50 1/2	18

Shown with 90485 tabletop/Montrée avec le dessus de table 90485
Colors shown/Couleurs montrées : Black coral/Noir corail (25)/
Verdastro (39)

COMPATIBLE TABLETOPS DESSUS DE TABLE COMPATIBLES		Thickness Épaisseur in/po	38 x 84	39 1/2 x 83 1/2	40 x 84	40 x 84+18 (2)
Solid wood (birch) <i>Bois massif (merisier)</i>	Distressed/Usé	1 1/2			90485	90481
	78 79 80 81 82 84 86 87 89 93					
Solid wood (birch) with decorative bolts <i>Bois massif (merisier) avec vis décoratives</i>	Non-distressed/Non usé	1 1/2			90484	90480
	39 41 42 43 44 46 47 48 49 96					
Solid wood (ash) <i>Bois massif (frêne)</i>	A1 A2 A3 A6 A7	1 1/2			93485	93481
	A1 A2 A3 AV	1 1/16	93484			
Wood veneer (birch) <i>Placage de bois (merisier)</i>	39 41 42 43 44	1			90864	
	46 48 49					
Wood veneer (walnut) <i>Placage de bois (noyer)</i>	47 96	1			90866	



Tayra 50996

FOR GLASS AND TFL TABLETOPS
POUR DESSUS EN VERRE ET TFL

TABLE BASE (table height)

BASE DE TABLE (hauteur table)

in/po	W/L	D/P	H
Overall/Hors-tout	24 3/4	41 1/2	29
Distance between legs at seat height Distance entre les pattes à la hauteur siège	—	30	18

Shown with 91280 tabletop / Montrée avec le dessus de table 91280

Colors shown / Couleurs montrées : Black coral / Noir corail (25) / Starstone
on glass Lava (70) / Starstone sur verre Lava (70)

COMPATIBLE TABLETOPS DESSUS DE TABLE COMPATIBLES		Thickness Épaisseur in/po	36 x 60
Mat black glass Verre noir mat	Mat black Noir mat	1/2	90270
Ultra white glass Verre ultra blanc	Ultra white Ultra blanc	1/2	90280
Porcelain on glass Porcelaine sur verre	Black marble finish Fini marbre noir	1/2	91290
	Statuario marble finish Fini marbre statuario	1/2	90290
Starstone on glass Starstone sur verre	70 71	1/2	91280
Thermo fused laminate (TFL) Panneau laminé	28 30 33 34	1	90536
		15/8	90562



Tayra 50997 FOR GLASS AND TFL TABLETOPS
 POUR DESSUS EN VERRE ET TFL

TABLE BASE (table height)	BASE DE TABLE (hauteur table)		
in/po	W/L	D/P	H
Overall / Hors-tout	24 3/4	50	29
Distance between legs at seat height <i>Distance entre les pattes à la hauteur siège</i>	—	38 1/2	18

Shown with 90281 tabletop / Montrée avec le dessus de table 90281
 Colors shown / Couleurs montrées : Black coral / Noir corail (25) / Ultra white
 glass / Verre ultra blanc

COMPATIBLE TABLETOPS DESSUS DE TABLE COMPATIBLES		Thickness Épaisseur in/po	39 1/2 x 71 1/2	40 x 72
Mat black glass <i>Verre noir mat</i>	Mat black <i>Noir mat</i>	1/2	90261	
Ultra white glass <i>Verre ultra blanc</i>	Ultra white <i>Ultra blanc</i>	1/2	90281	
Porcelain on glass <i>Porcelaine sur verre</i>	Black marble finish <i>Fini marbre noir</i>	1/2	91291	
	Statuario marble finish <i>Fini marbre statuario</i>	1/2	90291	
Starstone on glass <i>Starstone sur verre</i>	70 71	1/2	91281	
Thermo fused laminate (TFL) <i>Panneau laminé</i>	28 30 33 34	1	90563	
		15/8		90586



Tayra 50998

FOR GLASS AND TFL TABLETOPS
POUR DESSUS EN VERRE ET TFL

TABLE BASE (table height)

BASE DE TABLE (hauteur table)

in/po	W/L	D/P	H
Overall/Hors-tout	24 3/4	62	29
Distance between legs at seat height Distance entre les pattes à la hauteur siège	—	50 1/2	18

Shown with 91293 tabletop / Montrée avec le dessus de table 91293

Colors shown / Couleurs montrées : Black coral / Noir corail (25) /
Porcelain on glass black marble finish / Porcelaine sur verre fini marbre noir

COMPATIBLE TABLETOPS DESSUS DE TABLE COMPATIBLES		Thickness Épaisseur in/po	39 1/2 x 83 1/2	40 x 84
Mat black glass Verre noir mat	Mat black Noir mat	1/2	90263	
Ultra white glass Verre ultra blanc	Ultra white Ultra blanc	1/2	90283	
Porcelain on glass Porcelaine sur verre	Black marble finish Fini marbre noir	1/2	91293	
	Statuario marble finish Fini marbre statuario	1/2	90293	
Starstone on glass Starstone sur verre	70 71	1/2	91283	
Thermo fused laminate (TFL) Panneau laminé	28 30 33 34	1	90564	
		15/8		90585



Zoel 51460 FOR SOLID WOOD TABLETOP
POUR DESSUS EN BOIS MASSIF

NEW
TABLE BASE
(table height)

NOUVEAU
BASE DE TABLE
(hauteur table)

in/po	W/L	D/P	H
Overall/Hors-tout	20	14 5/8	29 1/8
Distance between legs at seat height <i>Distance entre les pattes à la hauteur siège</i>	36 x 60	—	34 1/8 18
Distance between legs at seat height <i>Distance entre les pattes à la hauteur siège</i>	40 x 72	—	46 1/8 18
Distance between legs at seat height <i>Distance entre les pattes à la hauteur siège</i>	40 x 84	—	58 1/8 18

Shown with 90485 tabletop / Montrée avec le dessus de table 90485
Colors shown / Couleurs montrées : Black coral / Noir corail (25) / Auburn (28) / Mouse (49)

COMPATIBLE TABLETOPS DESSUS DE TABLE COMPATIBLES		Thickness Épaisseur in/po	36 x 60	40 x 72	40 x 84
Solid wood (birch) <i>Bois massif (merisier)</i>	Distressed / Usé	1 1/2	90410* 91462	90487	90485
	78 79 80 81 82 84 86 87 89 93				
Solid wood (birch) with decorative bolts <i>Bois massif (merisier) avec vis décoratives</i>	Non-distressed / Non usé	1 1/2	91461	90486	90484
	39 41 42 43 44 46 47 48 49 96				
Solid wood (ash) <i>Bois massif (frêne)</i>	A1 A2 A3 A6 A7 A8 A9 AA AV	1 1/2	93410*	93487	93485

* Thickness of 1 1/16 / Épaisseur de 1 1/16



Zoel 51560 FOR WOOD VENEER AND TFL TABLETOP
POUR DESSUS EN PLACAGE DE BOIS ET TFL

NEW
TABLE BASE
(table height)

NOUVEAU
BASE DE TABLE
(hauteur table)

in/po	W/L	D/P	H
Overall / Hors-tout	20	36 1/8	29 1/8
Distance between legs at seat height Distance entre les pattes à la hauteur siège	—	34 1/8	18

Shown with 90562 tabletop / Montrée avec le dessus de table 90562
Colors shown / Couleurs montrées : Black coral / Noir corail (25) /
Basalt (30) / Basalt (30)

COMPATIBLE TABLETOPS DESSUS DE TABLE COMPATIBLES								Thickness Épaisseur in/po	36 x 60 	
Wood veneer (birch) Placage de bois (merisier)	39	41	42	43	44	46	48	49	1	90860
Wood veneer (walnut) Placage de bois (noyer)	47	96							1	90861
Thermo fused laminate (TFL) Panneau laminé	28	30	33	34					1	90536
									15/8	90562



Zoel 51572 FOR WOOD VENEER AND TFL TABLETOP
POUR DESSUS EN PLACAGE DE BOIS ET TFL

NEW
TABLE BASE
(table height)

NOUVEAU
BASE DE TABLE
(hauteur table)

in/po	W/L	D/P	H
Overall / Hors-tout	20	48 1/8	29 1/8
Distance between legs at seat height Distance entre les pattes à la hauteur siège	—	46 1/8	18

Shown with 90586 tabletop / Montrée avec le dessus de table 90586
Colors shown / Couleurs montrées : Black coral / Noir corail (25) /
Basalt (30) / Basalt (30)

COMPATIBLE TABLETOPS DESSUS DE TABLE COMPATIBLES		Thickness Épaisseur in/po	39 1/2 x 71 1/2	40 x 72
Wood veneer (birch) Placage de bois (merisier)	39 41 42 43 44 46 48 49	1	90863	
Wood veneer (walnut) Placage de bois (noyer)	47 96	1	90865	
Thermo fused laminate (TFL) Panneau laminé	28 30 33 34	1	90563	
		1 5/8		90586



Zoel 51584 FOR WOOD VENEER AND TFL TABLETOP
POUR DESSUS EN PLACAGE DE BOIS ET TFL

NEW
TABLE BASE
(table height)

NOUVEAU
BASE DE TABLE
(hauteur table)

in/po	W/L	D/P	H
Overall / Hors-tout	20	60 1/8	29 1/8
Distance between legs at seat height <i>Distance entre les pattes à la hauteur siège</i>	—	58 1/8	18

Shown with 90585 tabletop / Montrée avec le dessus de table 90585
Colors shown / Couleurs montrées : Black coral / Noir corail (25) /
Basalt (30) / Basalt (30)

COMPATIBLE TABLETOPS DESSUS DE TABLE COMPATIBLES		Thickness Épaisseur in/po	39 1/2 x 83 1/2	40 x 84
Wood veneer (birch) <i>Placage de bois (merisier)</i>	39 41 42 43 44 46 48 49	1	90864	
Wood veneer (walnut) <i>Placage de bois (noyer)</i>	47 96	1	90866	
Thermo fused laminate (TFL) <i>Panneau laminé</i>	28 30 33 34	1	90564	
		1 5/8		90585



Zoom 50522 EXTENDABLE TABLE TABLE EXTENSIBLE

TABLE BASE (table height)

BASE DE TABLE (hauteur table)

in/po	W/L	D/P	H
Overall/Hors-tout	38	60	29
Distance between legs at seat height Distance entre les pattes à la hauteur siège	34	56	18

Shown with 90591 tabletop/ Montrée avec le dessus de table 90591
Colors shown/ Couleurs montrées : Black coral/ Noir corail (25)/
Concrete (34)



FEATURES

- Opens easily and effortlessly by one person
- Ball bearing slide mechanism
- Built-in leaf storage

CARACTÉRISTIQUES

- Ouverture simple et sans effort par une seule personne
- Mécanisme de coulisses à billes synchronisées
- Rangement intégré pour les rallonges

COMPATIBLE TABLETOPS DESSUS DE TABLE COMPATIBLES		Thickness Épaisseur in/po	38 1/8 x 60+15	38 1/8 x 60+15 (2)
Solid wood (birch) Bois massif (merisier)	Distressed/Usé 78 79 80 81 82 84 86 87 89 93	1 1/2	90465	90461
Solid wood (birch) with decorative bolts Bois massif (merisier) avec vis décoratives	Non-distressed/Non usé 39 41 42 43 44 46 47 48 49 96	1 1/2	90464	90460
Solid wood (ash) Bois massif (frêne)	A1 A2 A3 A6 A7 A8 A9 AA AV	1 1/2	93465	93461
Wood veneer (birch) Placage de bois (merisier)	39 41 42 43 44 46 48 49	1		90891
Wood veneer (walnut) Placage de bois (noyer)	47 96	1		90892
Thermo fused laminate (TFL) Panneau laminé	28 30 33 34	1		90591

Zenith Table Bases / Bases de table Zenith

Your décor is unique! To enhance your interior, the Amisco team designed the Zenith extendable table bases available in three sizes. Thanks to ball bearings and invisible floor casters, each table base can be opened easily and quickly by one person. The Zenith table bases are versatile and surprising! They allow you to combine seven tabletop finishes with three different butterfly leaf finishes. The butterfly leaf is easily stored in the table base. Customize your Zenith table with the configurator on our amisco.com website. You will discover a multitude of possible combinations that will suit your décor.

Votre décor est unique! Pour mettre en valeur votre intérieur, les designers Amisco ont conçu les bases de table extensibles Zenith disponibles en trois dimensions. Grâce au roulement à billes et aux roulettes invisibles au sol, chaque base de table s'ouvre facilement et rapidement par une seule personne. Les bases de table Zenith sont polyvalentes et surprenantes ! Elles permettent de combiner sept finis de dessus de table avec trois différents finis de rallonge papillon. La rallonge papillon se range aisément dans la base de table. Personnalisez votre table Zenith avec le configurateur sur notre site amisco.com. Vous y découvrirez une multitude de combinaisons possibles qui sauront s'agencer à votre décor.



Zenith table shown without butterfly leaf
Table Zenith montrée sans la rallonge papillon



Zenith table shown with butterfly leaf
Table Zenith montrée avec la rallonge papillon



Side view / *Vue de côté* :
Italian porcelain on glass with walnut wood veneer
Porcelaine italienne sur verre avec placage de noyer



Side view / *Vue de côté* :
Birch wood veneer with thermo fused laminate (TFL)
Placage de merisier avec panneau laminé (TFL)



Zenith 52560

EXTENDABLE TABLE BASE

Dimensions : 35 1/4" x 59 1/4" - 83" x 29 1/2"

Color shown / Couleur montrée : Black coral / Noir corail (25)

BASE DE TABLE EXTENSIBLE





92503

Thermo fused laminate (TFL) tabletop - 36" x 60" with a 23 3/4" walnut wood veneer butterfly leaf

Dessus de table en panneau laminé (TFL) - 36" x 60" avec une rallonge papillon de 23 3/4" en placage de noyer

Colors shown / Couleurs montrées : Basalt (30) / Pine cone (96)

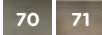
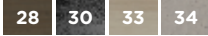
Compatible Tabletops Dessus de table compatibles

Tabletops / Dessus de table - (36" x 60")	Butterfly leaves / Rallonges papillon - (23 3/4")	Product no. / No de produit
Ultra white glass Verre ultra blanc 	Thermo fused laminate (TFL) Panneau laminé	28 30 33 34 92221
	Wood veneer (birch) Placage de (merisier)	39 41 42 43 44 46 48 49 92222
	Wood veneer (walnut) Placage de (noyer)	47 96 92223
Italian porcelain on glass (statuario marble finish) Porcelaine italienne sur verre (fini marbre statuario) 	Thermo fused laminate (TFL) Panneau laminé	28 30 33 34 92231
	Wood veneer (birch) Placage de (merisier)	39 41 42 43 44 46 48 49 92232
	Wood veneer (walnut) Placage de (noyer)	47 96 92233
Italian porcelain on glass (black marble finish) Porcelaine italienne sur verre (fini marbre noir) 	Thermo fused laminate (TFL) Panneau laminé	28 30 33 34 92241
	Wood veneer (birch) Placage de (merisier)	39 41 42 43 44 46 48 49 92242
	Wood veneer (walnut) Placage de (noyer)	47 96 92243
Starstone on glass Starstone sur verre 	Thermo fused laminate (TFL) Panneau laminé	28 30 33 34 92251
	Wood veneer (birch) Placage de (merisier)	39 41 42 43 44 46 48 49 92252
	Wood veneer (walnut) Placage de (noyer)	47 96 92253
Thermo fused laminate (TFL) Panneau laminé 	Thermo fused laminate (TFL) Panneau laminé	28 30 33 34 92501
	Wood veneer (birch) Placage de (merisier)	39 41 42 43 44 46 48 49 92502
	Wood veneer (walnut) Placage de (noyer)	47 96 92503
Wood veneer (birch) Placage de (merisier) 	Thermo fused laminate (TFL) Panneau laminé	28 30 33 34 92801
	Wood veneer (birch) Placage de (merisier)	39 41 42 43 44 46 48 49 92802
	Wood veneer (walnut) Placage de (noyer)	47 96 92803
Wood veneer (walnut) Placage de (noyer) 	Thermo fused laminate (TFL) Panneau laminé	28 30 33 34 92811
	Wood veneer (birch) Placage de (merisier)	39 41 42 43 44 46 48 49 92812
	Wood veneer (walnut) Placage de (noyer)	47 96 92813

The tabletop and the butterfly leaf can be ordered in the same finish and color for these 3 product numbers.

Le dessus de table et la rallonge papillon peuvent être commandés dans le même fini et la même couleur pour ces 3 numéros de produits.



Zenith 52572

92226

EXTENDABLE TABLE BASE

Dimensions : 38 3/4" x 70 3/4" - 106 3/4" x 29 1/2"







Color shown/Couleur montrée : Titanium (56)

BASE DE TABLE EXTENSIBLE

Ultra white glass tabletop - 39 1/2" x 71 1/2" with a 36" walnut wood veneer butterfly leaf
Dessus de table en verre ultra blanc - 39 1/2" x 71 1/2" avec une rallonge papillon de 36" en placage de noyer

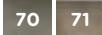
Colors shown/Couleurs montrées : Ultra white/Tiramisu (47)

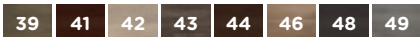
Compatible Tabletops Dessus de table compatibles

Tabletops/Dessus de table - (39 1/2" x 71 1/2")	Butterfly leaves/Rallonges papillon - (36")	Product no./ No de produit
Ultra white glass Verre ultra blanc 	Thermo fused laminate (TFL) Panneau laminé	28 30 33 34 92224
	Wood veneer (birch) Placage de (merisier)	39 41 42 43 44 46 48 49 92225
	Wood veneer (walnut) Placage de (noyer)	47 96 92226
Italian porcelain on glass (statuario marble finish) Porcelaine italienne sur verre (fini marbre statuario) 	Thermo fused laminate (TFL) Panneau laminé	28 30 33 34 92234
	Wood veneer (birch) Placage de (merisier)	39 41 42 43 44 46 48 49 92235
	Wood veneer (walnut) Placage de (noyer)	47 96 92236
Italian porcelain on glass (black marble finish) Porcelaine italienne sur verre (fini marbre noir) 	Thermo fused laminate (TFL) Panneau laminé	28 30 33 34 92244
	Wood veneer (birch) Placage de (merisier)	39 41 42 43 44 46 48 49 92245
	Wood veneer (walnut) Placage de (noyer)	47 96 92246
Starstone on glass Starstone sur verre 	Thermo fused laminate (TFL) Panneau laminé	28 30 33 34 92254
	Wood veneer (birch) Placage de (merisier)	39 41 42 43 44 46 48 49 92255
	Wood veneer (walnut) Placage de (noyer)	47 96 92256
Thermo fused laminate (TFL) Panneau laminé 	Thermo fused laminate (TFL) Panneau laminé	28 30 33 34 92504
	Wood veneer (birch) Placage de (merisier)	39 41 42 43 44 46 48 49 92505
	Wood veneer (walnut) Placage de (noyer)	47 96 92506
Wood veneer (birch) Placage de (merisier) 	Thermo fused laminate (TFL) Panneau laminé	28 30 33 34 92804
	Wood veneer (birch) Placage de (merisier)	39 41 42 43 44 46 48 49 92805
	Wood veneer (walnut) Placage de (noyer)	47 96 92806
Wood veneer (walnut) Placage de (noyer) 	Thermo fused laminate (TFL) Panneau laminé	28 30 33 34 92814
	Wood veneer (birch) Placage de (merisier)	39 41 42 43 44 46 48 49 92815
	Wood veneer (walnut) Placage de (noyer)	47 96 92816

The tabletop and the butterfly leaf can be ordered in the same finish and color for these 3 product numbers.

Le dessus de table et la rallonge papillon peuvent être commandés dans le même fini et la même couleur pour ces 3 numéros de produits.



Zenith 52584

EXTENDABLE TABLE BASE

Dimensions : 38 3/4" x 82 3/4" - 118 3/4" x 29 1/2"

Color shown / Couleur montrée : Metallo (57)





BASE DE TABLE EXTENSIBLE

92238

Italian porcelain on glass tabletop - 39 1/2" x 83 1/2"
with a 36" birch wood veneer butterfly leaf
*Dessus de table en porcelaine italienne sur verre 39 1/2" x 83 1/2" avec
une rallonge papillon de 36" en placage
de merisier*

Colors shown / Couleurs montrées : Statuario marble /
Marbre statuario / Mouse (49)

Compatible Tabletops Dessus de table compatibles

Tabletops / Dessus de table - (39 1/2" x 83 1/2")	Butterfly leaves / Rallonges papillon - (36")	Product no. / No de produit
Ultra white glass <i>Verre ultra blanc</i> 	Thermo fused laminate (TFL) <i>Panneau laminé</i> 28 30 33 34	92227
	Wood veneer (birch) <i>Placage de (merisier)</i> 39 41 42 43 44 46 48 49	92228
	Wood veneer (walnut) <i>Placage de (noyer)</i> 47 96	92229
Italian porcelain on glass (statuario marble finish) <i>Porcelaine italienne sur verre (fini marbre statuario)</i> 	Thermo fused laminate (TFL) <i>Panneau laminé</i> 28 30 33 34	92237
	Wood veneer (birch) <i>Placage de (merisier)</i> 39 41 42 43 44 46 48 49	92238
	Wood veneer (walnut) <i>Placage de (noyer)</i> 47 96	92239
Italian porcelain on glass (black marble finish) <i>Porcelaine italienne sur verre (fini marbre noir)</i> 	Thermo fused laminate (TFL) <i>Panneau laminé</i> 28 30 33 34	92247
	Wood veneer (birch) <i>Placage de (merisier)</i> 39 41 42 43 44 46 48 49	92248
	Wood veneer (walnut) <i>Placage de (noyer)</i> 47 96	92249
Starstone on glass <i>Starstone sur verre</i> 	Thermo fused laminate (TFL) <i>Panneau laminé</i> 28 30 33 34	92257
	Wood veneer (birch) <i>Placage de (merisier)</i> 39 41 42 43 44 46 48 49	92258
	Wood veneer (walnut) <i>Placage de (noyer)</i> 47 96	92259
Thermo fused laminate (TFL) <i>Panneau laminé</i> 28 30 33 34	Thermo fused laminate (TFL) <i>Panneau laminé</i> 28 30 33 34	92507
	Wood veneer (birch) <i>Placage de (merisier)</i> 39 41 42 43 44 46 48 49	92508
	Wood veneer (walnut) <i>Placage de (noyer)</i> 47 96	92509
Wood veneer (birch) <i>Placage de (merisier)</i> 39 41 42 43 44 46 48 49	Thermo fused laminate (TFL) <i>Panneau laminé</i> 28 30 33 34	92807
	Wood veneer (birch) <i>Placage de (merisier)</i> 39 41 42 43 44 46 48 49	92808
	Wood veneer (walnut) <i>Placage de (noyer)</i> 47 96	92809
Wood veneer (walnut) <i>Placage de (noyer)</i> 47 96	Thermo fused laminate (TFL) <i>Panneau laminé</i> 28 30 33 34	92817
	Wood veneer (birch) <i>Placage de (merisier)</i> 39 41 42 43 44 46 48 49	92818
	Wood veneer (walnut) <i>Placage de (noyer)</i> 47 96	92819

The tabletop and the butterfly leaf can be ordered in the same finish and color for these 3 product numbers.
Le dessus de table et la rallonge papillon peuvent être commandés dans la même finis et la même couleur pour ces 3 numéros de produit.



Tabletops Dessus de table

Clear Glass Tabletops Dessus de table en verre clair



CLEAR GLASS (flat edge)

VERRE CLAIR (chant droit)

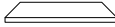
in/po	Product # # de Produit	Dimension Dimension	Thickness Épaisseur
	90244	24 dia.	1/2
	90230	30 dia.	1/2
	90236	36 dia.	1/2
	90242	42 dia.	1/2
	90247	48 dia.	1/2
	90245	19 1/2 x 19 1/2	1/2
	90246	36 x 36	1/2
	90248	28 x 48	1/2
	90260	36 x 60	1/2
	90271	39 1/2 x 71 1/2	1/2
	90273	39 1/2 x 83 1/2	1/2



CLEAR GLASS (beveled edge)

VERRE CLAIR (chant biseau)

in/po	Product # # de Produit	Dimension Dimension	Thickness Épaisseur
	90376	36 dia.	3/8
	90375	42 dia.	3/8
	90378	48 dia.	3/8

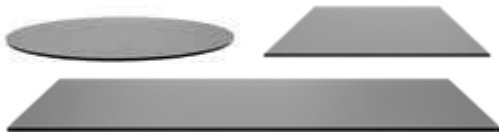

Painted Glass Tabletops Dessus de table en verre peint

For this type of glass tabletop, a paint is applied underneath the surface of the glass which tints the tabletop of an opaque color and eliminates the risk of scratches and wear. / Pour ce type de dessus de table, la peinture est appliquée sous la surface du verre, ce qui rend le dessus de table d'une couleur opaque et élimine les risques d'égratignures et d'usure.



MAT BLACK GLASS (flat edge)



VERRE NOIR MAT (chant droit)

in/po	Product # # de Produit	Dimension Dimension	Thickness Épaisseur
	90264	24 dia.	1/2
	90266	36 dia.	1/2
	90262	42 dia.	1/2
	90267	48 dia.	1/2
	90265	19 1/2 x 19 1/2	1/2
	90037	23 7/8 x 23 7/8	1/2
	90269	36 x 36	1/2
	90268	28 x 48	1/2
	90270	36 x 60	1/2
	90261	39 1/2 x 71 1/2	1/2
	90263	39 1/2 x 83 1/2	1/2



ULTRA WHITE GLASS (flat edge)



VERRE ULTRA BLANC (chant droit)

in/po	Product # # de Produit	Dimension Dimension	Thickness Épaisseur
	90284	24 dia.	1/2
	90286	36 dia.	1/2
	90282	42 dia.	1/2
	90287	48 dia.	1/2
	90285	19 1/2 x 19 1/2	1/2
	90039	23 7/8 x 23 7/8	1/2
	90289	36 x 36	1/2
	90288	28 x 48	1/2
	90280	36 x 60	1/2
	90281	39 1/2 x 71 1/2	1/2
	90283	39 1/2 x 83 1/2	1/2

Italian Porcelain on Glass Tabletops Dessus de table en porcelaine italienne sur verre



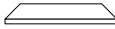

BLACK MARBLE FINISH (flat edge)

in/po	Product # # de Produit	Dimension Dimension	Thickness Épaisseur
	91294	24 dia.	1/2
	91292	39 dia.	1/2
	91295	19 1/2 x 19 1/2	1/2
	91298	28 x 48	1/2
	91290	36 x 60	1/2
	91291	39 1/2 x 71 1/2	1/2
	91293	39 1/2 x 83 1/2	1/2

FINI MARBRE NOIR (chant droit)

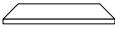

STATUARIO MARBLE FINISH (flat edge)

in/po	Product # # de Produit	Dimension Dimension	Thickness Épaisseur
	90294	24 dia.	1/2
	90292	39 dia.	1/2
	90295	19 1/2 x 19 1/2	1/2
	90298	28 x 48	1/2
	90290	36 x 60	1/2
	90291	39 1/2 x 71 1/2	1/2
	90293	39 1/2 x 83 1/2	1/2

FINI MARBRE STATUARIO (chant droit)

Why choosing porcelain on glass over real marble?

Easier to clean and maintain

- Does not stain
- Can be cleaned with regular domestic cleaning products
- Non porous
- More resistant to bacteria and mold

More resistant

- More resistant to abrasion and scratches
- More resistant to heat

More durable

- Does not turn yellow
- Does not require a sealer application

Pourquoi choisir la porcelaine sur verre plutôt que le vrai marbre?

Plus facile d'entretien

- Ne tache pas
- Peut être nettoyé avec des produits de nettoyage domestique réguliers
- Non poreux
- Plus résistant aux bactéries et à la moisissure

Plus résistant

- Plus résistant à l'abrasion et aux égratignures
- Plus résistant à la chaleur

Plus durable

- Ne jaunit pas
- Ne nécessite pas l'ajout d'un scellant

Starstone on Glass Tabletops Dessus de table Starstone sur verre

Starstone on glass colors available / Couleurs de Starstone sur verre disponibles

70 71

Color shown / Couleur montrée : Tuscan (71)



STARSTONE ON GLASS (flat edge)

STARSTONE SUR VERRE (chant droit)

in/ po	Product # # de Produit	Dimension Dimension	Thickness Épaisseur
	91284	24 dia.	1/2
	91286	36 dia.	1/2
	91282	42 dia.	1/2
	91287	48 dia.	1/2
	91285	19 1/2 x 19 1/2	1/2
	91288	28 x 48	1/2
	91280	36 x 60	1/2
	91281	39 1/2 x 71 1/2	1/2
	91283	39 1/2 x 83 1/2	1/2

Why choosing Starstone on glass over natural stone?

Easier to clean and maintain

- Does not stain
- Can be cleaned with regular domestic cleaning products
- Non porous
- More resistant to bacteria and mold

More resistant

- More resistant to abrasion and scratches
- More resistant to liquid spills and moisture

More durable

- Does not require a regular sealer application like stone

Pourquoi choisir le Starstone sur verre plutôt que de la pierre naturelle?

Plus facile à nettoyer et à entretenir

- Ne tache pas
- Peut être nettoyé avec des produits de nettoyage domestique réguliers
- Non poreux
- Plus résistant aux bactéries et aux moisissures

Plus résistant

- Plus résistant à l'abrasion et aux rayures
- Plus résistant aux déversements de liquides et à l'humidité

Plus durable

- Ne nécessite pas d'application régulière de scellant comme la pierre

<p>WARNING: Amisco cannot warrant the stability, the height and the sturdiness of a table that is not a combination listed in this grid.</p> <p>AVERTISSEMENT: Amisco ne peut garantir la stabilité, la hauteur et la solidité d'une table n'utilisant pas les combinaisons de cette grille.</p>		Glass/Italian porcelain on glass/Starstone on glass Verre/Porcelaine italienne sur verre/Starstone sur verre															
		23 7/8 x 23 7/8 90037/039	30 dia. 90230	36 dia. 90236/266/286/376//91286	39 dia. 90292/91292	42 dia. 90242/375	42 dia. 90262/282//91282	48 dia. 90378/247	48 dia. 90267/287//91287	36 x 36 90246/269/289	28 x 48 90248/268/288//91288/298	36 x 60 90270/280/290//91280/290	36 x 60 90260	39 1/2 x 71 1/2 90271	39 1/2 x 71 1/2 90261/281/291//91281/291	39 1/2 x 83 1/2 90273	39 1/2 x 83 1/2 90263/283/293//91283/293
TABLE BASES/ BASES DE TABLE																	
Regular / Régulière	50507 Dalia		•	•	•	•	•	•	•								
	50547 Dalia XL							•									
	50555 Link				•	•	•	•	•								
	50563 Norcross			•	•	•	•	•	•								
	50570 Alys			•	•	•	•	•	•								
	50571 Moris			•	•	•	•	•	•								
	50580 Alys										•	•	•	•			
	50607 Kai*			•	•	•	•	•	•								
	50634 Dirk			•	•	•	•	•	•	•							
	50936 Lidya										•	•					
	50952 Link												•	•			
	50953 Link														•	•	
	50960 Bennington												•	•			
	50962 Carbon									•							
	50964 Ricard										•	•					
	50967 Nicholson														•	•	
	50968 Harrison									•							
	50972 Lidya												•	•			
	50984 Lidya														•	•	
	50996 Tayra										•						
50997 Tayra													•				
50998 Tayra															•		
High / Haute	50507-38/42 Dalia		•	•	•	•	•		•								
	50537-38/42 Aden	•															
	50554-36/42 Link			•	•	•	•		•								
	50563-36/42 Norcross			•	•	•	•		•								
	50707/807 Kai*			•	•	•	•										
	50734/834 Dirk			•	•	•	•		•								
	50960-36/42 Bennington												•	•			
	50962-36/42 Carbon									•							
	50964-36/42 Ricard										•	•					
	50967-36/42 Nicholson														•	•	
	50968-36/42 Harrison									•							
	51522-36/42 Calypso						•		•								
	51524-36/42 Calypso						•		•								
	51526-36/42 Calypso						•		•								
	51528-36/42 Calypso						•		•								

* We do not recommend the use of painted glass or porcelain on glass or starstone on glass with this table base to not hide its design.
 Nous ne recommandons pas l'utilisation d'un dessus de table en verre peint ou en porcelaine sur verre ou en starstone sur verre avec cette base de table pour ne pas en cacher le design.

Solid Wood Tabletops (birch) Dessus de table en bois massif (merisier)

Finished with a catalysed lacquer / Finis avec une laque catalysée

Wood colors available / Couleurs de bois disponibles
Distressed / Usé

78	79	80	81	82	84	86	87	89	93
----	----	----	----	----	----	----	----	----	----

Non-distressed / Non usé

39	41	42	43	44	46	47	48	49	96
----	----	----	----	----	----	----	----	----	----

Color shown / Couleur montrée : Toasty (87)



in/po	Product # # de Produit	Dimension Dimension	Thickness Épaisseur
	90403	30 dia.	1 1/16
	90406	36 dia.	1 1/16
	90412	42 dia.	1 1/16
	50838-BO	23 7/8 x 23 7/8	7/8
	90408	36 x 36	1 1/16
	90851	28 x 48	1 1/16
	90405	32 x 54	1 1/16
	90410	36 x 60	1 1/16



in/po	Product # # de Produit	Dimension Dimension	Thickness Épaisseur
	91462	36 x 60	1 1/2
	90487	40 x 72	1 1/2
	90485	40 x 84	1 1/2
	90483	40 x 72-108	1 1/2
	90481	40 x 84-120	1 1/2



in/po	Product # # de Produit	Dimension Dimension	Thickness Épaisseur
	90464	38 1/8 x 60-75 3/8	1 1/2
	90465	38 1/8 x 60-75 3/8	1 1/2
	91490	38 1/8 x 72-87 1/8	1 1/2
	91491	38 1/8 x 72-87 1/8	1 1/2



in/po	Product # # de Produit	Dimension Dimension	Thickness Épaisseur
	91461	36 x 60	1 1/2
	90486	40 x 72	1 1/2
	90484	40 x 84	1 1/2
	90482	40 x 72-108	1 1/2
	90480	40 x 84-120	1 1/2



in/po	Product # # de Produit	Dimension Dimension	Thickness Épaisseur
	90460	38 1/8 x 60-90 1/2	1 1/2
	90461	38 1/8 x 60-90 1/2	1 1/2
	91492	38 1/8 x 72-102 1/4	1 1/2
	91493	38 1/8 x 72-102 1/4	1 1/2



in/po	Product # # de Produit	Dimension Dimension	Thickness Épaisseur
	90492	20 x 20	1 1/16
	90491	54 x 15	1 1/16
	90493	48 x 23 3/4	1 1/16
	90494	54 x 15	1 1/16
	90494	54 x 8 3/4	1 1/16
	90497	72 x 15	1 1/16
	90497	72 x 8 3/4	1 1/16

Solid Wood Tabletops (ash) Dessus de table en bois massif (frêne)

Finished with a catalysed lacquer / Finis avec une laque catalysée

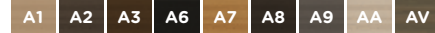

Wood colors available / Couleurs de bois disponibles

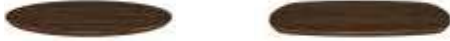

Color shown / Couleur montrée : Barrel (A3)



Beveled edge / Chant biseau

in/po	Product # # de Produit	Dimension Dimension	Thickness Épaisseur
	93406	36 dia.	1 1/16
	93412	42 dia.	1 1/16
	93460	36 x 60	1 1/16
	93472	38 x 72	1 1/16
	93484	38 x 84	1 1/16

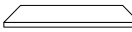
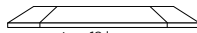
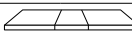
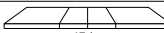

Flat edge / Chant droit

in/po	Product # # de Produit	Dimension Dimension	Thickness Épaisseur
	93492	20 x 20	1 1/16
	93408	36 x 36	1 1/16
	93428	28 x 48	1 1/16
	93410	36 x 60	1 1/16
	93487	40 x 72	1 1/2
	93485	40 x 84	1 1/2
	93483	40 x 72-108	1 1/2
two 18 leaves deux rallonges de 18	93481	40 x 84-120	1 1/2
	93465	38 1/8 x 60-75 3/8	1 1/2
15 leaf rallonge de 15			
	93461	38 1/8 x 60-90 1/2	1 1/2
two 15 leaves deux rallonges de 15			

Wood Veneer Tabletops (birch)/Dessus de table en placage de bois (merisier)



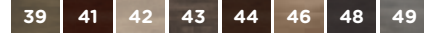

Finished with a catalysed lacquer / Finis avec une laque catalysée

Wood colors available / Couleurs de bois disponibles



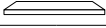

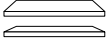

Color shown / Couleur montrée : Mouse (49)

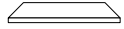

in/po	Product # # de Produit	Dimension Dimension	Thickness Épaisseur
	90882	20 x 20	1
	90881	54 x 15	1
	90883	48 x 23 3/4	1
	90884	54 x 15 54 x 8 3/4	1
	90887	72 x 15 72 x 8 3/4	1

in/po	Product # # de Produit	Dimension Dimension	Thickness Épaisseur
	90814	24 dia.	1
	90810	30 dia.	1
	90817	36 dia.	1
	90823	42 dia.	1
	90857	48 dia.	1

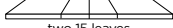
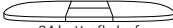

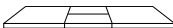
in/po	Product # # de Produit	Dimension Dimension	Thickness Épaisseur
	90834	23 7/8 x 23 7/8	1
	90827	36 x 36	1
	90849	28 x 48	1
	90845	32 x 54	1
	90860	36 x 60	1
	90863	39 1/2 x 71 1/2	1
	90864	39 1/2 x 83 1/2	1
	90840	40 x 72	1
 two 15 leaves deux rallonges de 15	90891	38 1/8 x 60-90 1/2	1
 24 butterfly leaf rallonge de 24 papillon	90895	38 x 72-95 3/4	1
 24 butterfly leaf rallonge de 24 papillon	90893	38 x 72-95 3/4	1
 24 butterfly leaf rallonge de 24 papillon	90888	38 x 72-95 3/4	1

Wood Veneer Tabletops (walnut)/Dessus de table en placage de bois (noyer)

Finished with a catalysed lacquer/Finis avec une laque catalysée

Wood colors available / Couleurs de bois disponibles

47 96

Color shown / Couleur montrée : Pine cone (96)



in/po	Product # # de Produit	Dimension Dimension	Thickness Épaisseur
	90872	20 x 20	1
	90871	54 x 15	1
	90873	48 x 23 3/4	1
	90874	54 x 15 54 x 8 3/4	1
	90877	72 x 15 72 x 8 3/4	1

in/po	Product # # de Produit	Dimension Dimension	Thickness Épaisseur
	90815	24 dia.	1
	90811	30 dia.	1
	90818	36 dia.	1
	90824	42 dia.	1
	90858	48 dia.	1



in/po	Product # # de Produit	Dimension Dimension	Thickness Épaisseur
	90835	23 7/8 x 23 7/8	1
	90828	36 x 36	1
	90850	28 x 48	1
	90846	32 x 54	1
	90861	36 x 60	1
	90865	39 1/2 x 71 1/2	1
	90866	39 1/2 x 83 1/2	1
	90841	40 x 72	1
	90892	38 1/8 x 60-90 1/2	1
	90896	38 x 72-95 3/4	1
	90894	38 x 72-95 3/4	1
	90889	38 x 72-95 3/4	1



Thermo Fused Laminate Tabletops (TFL)/Dessus de table en panneaux laminés (TFL)





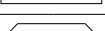
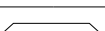
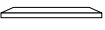
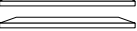

Finishes available / Finis disponibles

28 30 33 34

Color shown / Couleur montrée : Concrete (34)

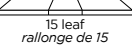
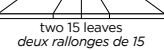

in/po	Product # # de Produit	Dimension Dimension	Thickness Épaisseur
	90524	24 dia.	1
	90582	20 x 20	1
	90581	54 x 15	1
	90583	48 x 23 3/4	1
	90584	54 x 15 54 x 8 3/4	1
	90587	72 x 15 72 x 8 3/4	1

in/po	Product # # de Produit	Dimension Dimension	Thickness Épaisseur
	90528	30 dia.	1
	90539	39 dia.	1
	90548*	48 dia.	1
	90538	23 7/8 x 23 7/8	1
	90527	36 x 36	1
	90549	28 x 48	1
	90554	32 x 54	1
	90536	36 x 60	1
	90562	36 x 60	15/8
	90563	39 1/2 x 71 1/2	1
	90586	40 x 72	15/8
	90564	39 1/2 x 83 1/2	1
	90585	40 x 84	15/8
	90542	40 x 72	1
	91591	38 1/8 x 72-87 1/8	1
	91592	38 1/8 x 72-102 1/4	1
	90591	38 1/8 x 60-90 1/2	1
	90595	38 x 72-95 3/4	1
	90594	38 x 72-95 3/4	1
	90592	38 x 72-95 3/4	1

*Available in Auburn (28) only
Disponible seulement en Auburn (28)

Why choosing Thermo Fused Laminate (TFL)?

Easy to clean and maintain

- Does not stain
- Can be cleaned with regular domestic cleaning products
- Resistant to bacteria and mold

Resistant

- More resistant to abrasion and scratches

Durable

- Does not require a regular sealer application

Pourquoi choisir le panneau laminé?

Facile à nettoyer et à entretenir

- Ne tache pas
- Peut être nettoyé avec des produits de nettoyage domestique réguliers
- Plus résistant aux bactéries et aux moisissures

Résistant

- Plus résistant à l'abrasion et aux rayures

Durable

- Ne nécessite pas d'application régulière de scellant ou de laque

Edge Types Types de chant

Glass/ Verre



Clear/ Clair

Beveled edge
Chant en biseau



Clear/ Clair

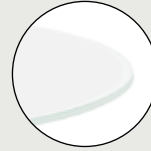

Ultra White/ Ultra blanc

Flat edge
Chant droit

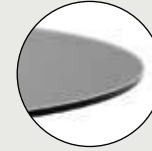

Mat Black/ Noir mat

Porcelain on glass/ Porcelaine sur verre



Statuario Marble Finish
Fini marbre statuario



Black Marble Finish
Fini marbre noir

Flat edge
Chant droit

Solid Wood/ Bois massif



Birch/ Merisier

Flat edge
Chant droit



Birch/ Merisier

Flat edge with decorative bolts
Chant droit avec vis décoratives

Solid Wood/ Bois massif



Ash/ Frêne

Flat edge
Chant droit



Ash/ Frêne

Beveled edge
Chant en biseau

Wood Veneer/ Placage de bois



Birch/ Merisier



Walnut/ Noyer

Flat edge
Chant droit

Seating Capacity / Places assises

Round tabletops / Dessus de table rond

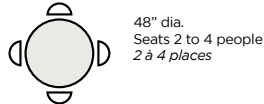
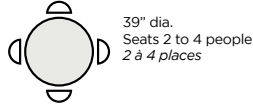
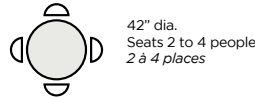
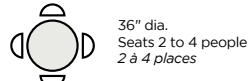
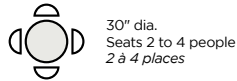

Square tabletops / Dessus de table carré

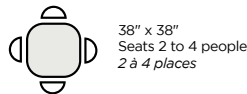
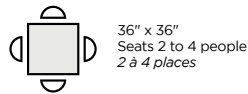

Rectangular tabletops / Dessus de table rectangle

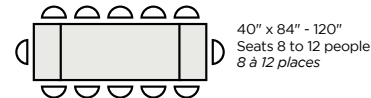
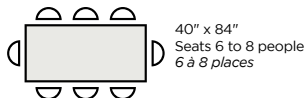
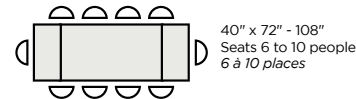
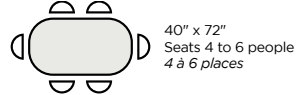
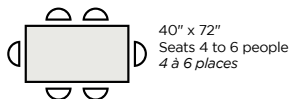
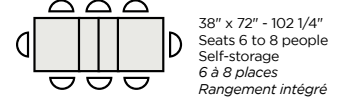
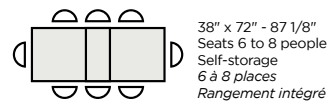
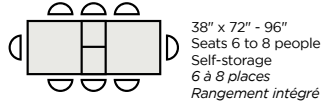
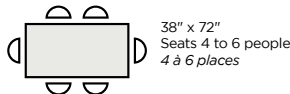
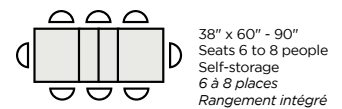
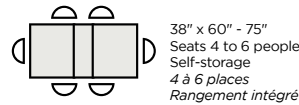
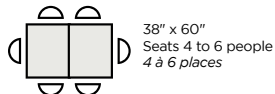
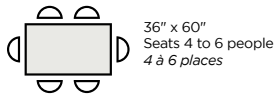
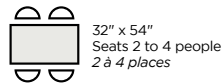
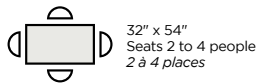
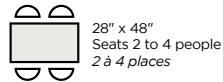
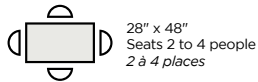

The suggested seating capacity is based on the size of the tabletops. In some cases, the number of seats will vary depending on the chairs and table bases chosen. Please make sure to check the measurements before ordering.

Le nombre suggéré de places assises est en fonction des dimensions des dessus de table. Dans certains cas, le nombre de places assises variera en fonction des chaises et des bases de table qui seront choisies. Bien vouloir vérifier les dimensions avant de commander.

Metal Finishes

Couleurs de métal



Semi-Transparent Finish

Finis semi-transparent



51 Harley

Please refer to the FAQ section of our catalogue for more details on the semi-transparent finish.

Veillez vous référer à la section FAQ de notre catalogue pour plus de détails sur le fini semi-transparent.

Hammered Finishes

Finis martelés

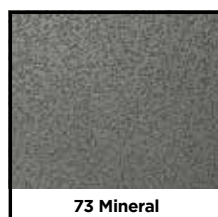

73 Mineral



74 Falcon



75 Cobrizo

The texture and the crater size may vary when compared to the color sample, or between products.

La texture et la taille des cratères peuvent varier par rapport à l'échantillon, et d'un produit à l'autre.

Decorative Accents

Accents décoratifs

Leather / Cuir

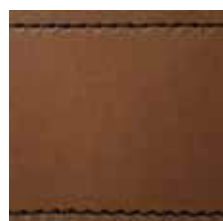

OT Tan



OB Black

Wood Colors

Couleurs de bois

Solid Wood (birch) / *Bois massif (merisier)*

Non-distressed / *Non usé*



Distressed / *Usé*



Solid Wood (birch) / *Bois massif (merisier)*

Non-distressed / *Non usé*

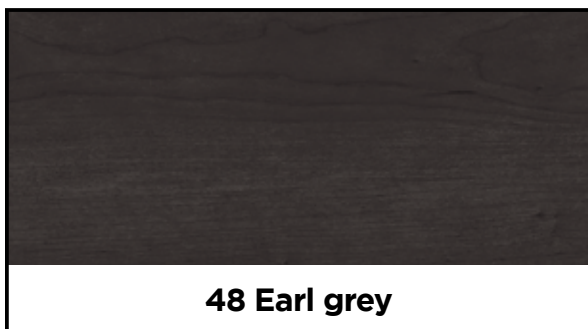
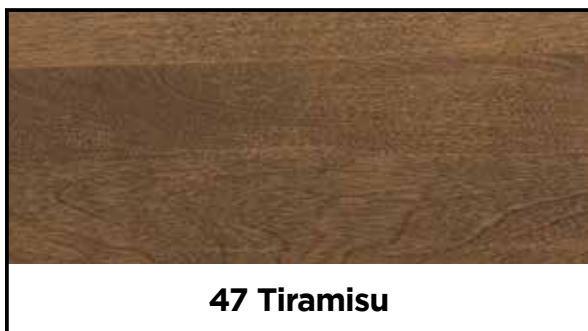

Distressed / *Usé*

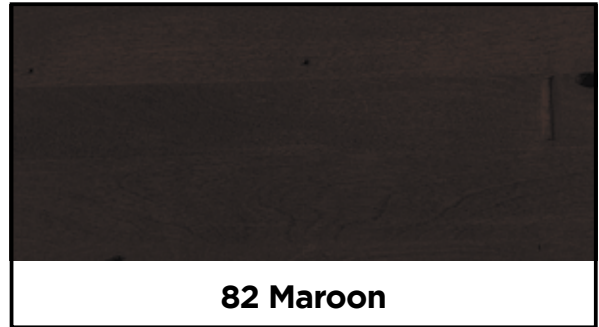

Solid Wood (birch) / Bois massif (merisier)

Non-distressed / Non usé



Distressed / Usé



Unfinished Option / Option Non peint

The Unfinished wood color can be ordered when you wish to stain the wood component yourself. This color is only available on solid wood and distressed solid wood accents and seats. The Unfinished wood components must be finished.

La couleur de bois Non peint peut être commandée si vous désirez teindre la composante de bois vous-même. Cette couleur est uniquement disponible sur les accents et sièges de bois massif et bois massif usé. Le fini Non peint ne peut pas demeurer sans finition.

Non-distressed / Non usé



Distressed / Usé



Solid Wood (ash) / Bois massif (frêne)

Solid ash only available when mentioned in the product description.
Frêne massif uniquement disponible lorsque mentionné dans le descriptif de produit.

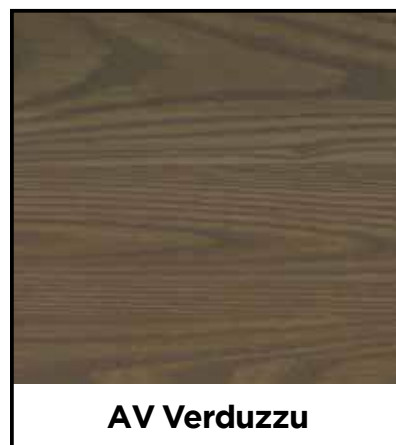
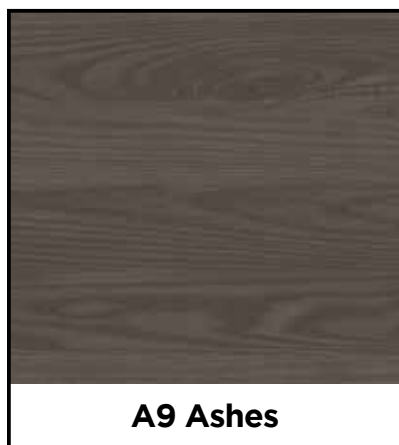
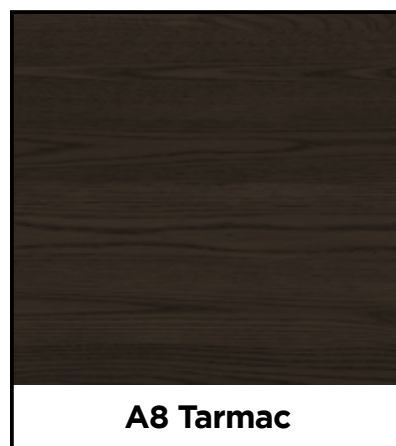
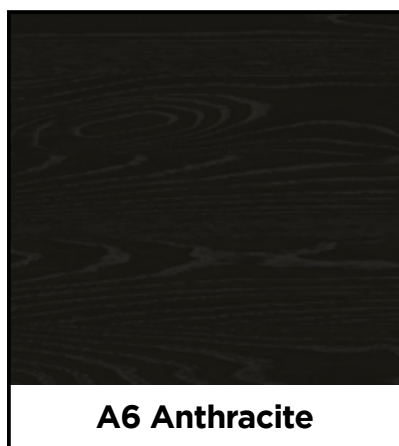
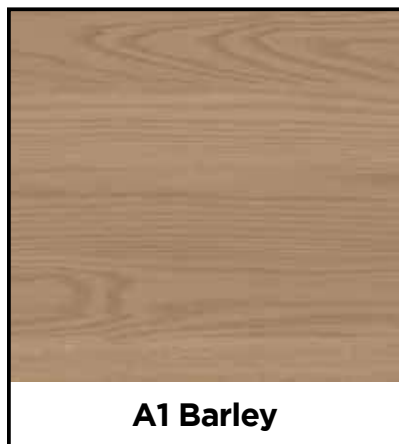

Wood Veneer (birch) / *Placage de bois (merisier)*

Birch wood veneer only available when mentioned in the product description.
Placage de merisier uniquement disponible lorsque mentionné dans le descriptif de produit.

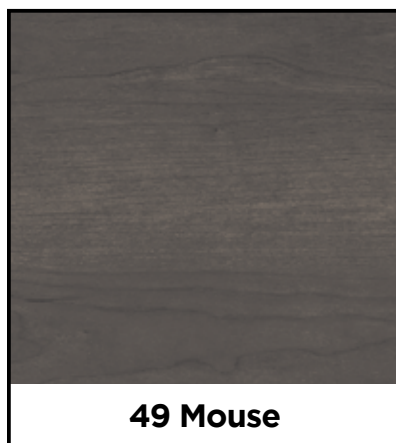
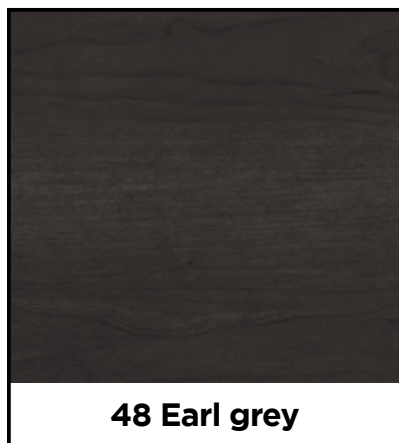

Wood Veneer (walnut) / *Placage de bois (noyer)*

Walnut wood veneer only available when mentioned in the product description.
Placage de noyer uniquement disponible lorsque mentionné dans le descriptif de produit.



10 Year Warranty

Garantie 10 ans

10 YEAR LIMITED RESIDENTIAL WARRANTY

AMISCO hereby warrants the welding and metal structure and the swivel plate of its products for a period of ten (10) years of residential use. This warranty applies also to swivel plates of products sold after April 1, 2019. Wood TFL and upholstered products have a one (1) year limited warranty. Metal, wood and upholstered products are warranted against damages caused by material and workmanship defects, occurring during a normal use and under the conditions for which the products are designed. The warranty does not cover normal wear of paint, lacquer, or upholstery covering.

Among other things, this warranty excludes decorative features, glass components, glides and other accessories. This warranty does not apply to defects resulting from improper use, care or assembly, from unauthorized repair or alteration or from negligence. This warranty does not cover transit and handling damages to products sold on the Internet or by catalogue, unless they are specifically designed and packaged for direct delivery to the consumer by AMISCO.

Under this warranty, AMISCO will, at its discretion, repair or replace the defective part at no cost except for transportation, handling and shipping costs which will be charged to the purchaser. The replacement parts are included in this warranty for the remainder of the original warranty period.

This is a limited warranty, any defect not specifically covered herein is excluded. Where allowed under the law, AMISCO disclaims liability for all special, incidental and consequential damages.

CLAIMS AND MERCHANDISE RETURNS

If parts are missing or received damaged, contact Amisco within 30 days from your purchase date. All warranty claims must be sent in writing to AMISCO together with the original or photocopy of the original purchase receipt. AMISCO reserves the right to ascertain the basis for a request and to demand justification pieces. Defective merchandise may not be returned until receipt of AMISCO'S written authorization and shipping instructions are given. AMISCO reserves the right to replace merchandise deemed defective with similar merchandise of same value if original merchandise is no longer available.

PAINT FINISHES

All AMISCO metal furniture are powder coated, which provides a durable and environmental friendly finish for indoor use.

SEMI-TRANSPARENT FINISH HARLEY (51)

AMISCO'S unique finish assure you that no two pieces will ever be identical since through this finish you are able to see details such as welding lines, sanding and other techniques bearing the touch of AMISCO'S many skilled metal craftsmen. A certain amount of discoloration of the steel in various spots is a natural occurrence in this process and should not be considered a defect.

Warranty in effect on products sold after April 1st, 2019.

GARANTIE RÉSIDENIELLE LIMITÉE 10 ANS

AMISCO, par la présente, garantit la soudure et la structure de métal et la plaque pivotante de ses produits pour une période de dix (10) ans en usage résidentiel. Cette garantie s'applique aussi aux plaques pivotantes des produits vendus après le 1^{er} avril 2019. Les produits et composants en bois, en TFL et rembourrés ont une garantie limitée d'un (1) an. Les produits de métal, de bois et les produits rembourrés sont garantis contre tous bris causés par un défaut de matériaux et de main-d'oeuvre, survenant au cours d'un usage normal et dans des conditions pour lesquelles les produits sont destinés. La garantie ne couvre pas l'usure normale de la peinture, de la laque ou du recouvrement de rembourrage.

Entre autres, cette garantie exclut les éléments décoratifs, les composants de verre, les glisseurs et autres accessoires. Cette garantie ne s'applique pas aux défauts résultant d'un usage, entretien ou assemblage inapproprié, de modifications ou réparations non autorisées ou de négligence. La garantie ne s'applique pas aux dommages subis durant le transport et la manutention des produits vendus par Internet ou par catalogue, à moins que ces produits n'aient été conçus et emballés par Amisco pour la livraison au consommateur.

En vertu de cette garantie, AMISCO, à sa discrétion, réparera ou remplacera les pièces défectueuses sans frais à l'exception du transport, de la manutention et de l'expédition dont les coûts seront imputés à l'acheteur. Sont incluses dans la présente garantie les pièces de rechange pour la durée de la période originale de garantie.

La présente garantie est limitée, tous défauts non spécifiquement mentionnés sont exclus. Lorsque permis en vertu de la loi, AMISCO renonce à toute responsabilité pour tout dommage direct ou indirect, incident ou consécutif.

RÉCLAMATIONS ET RETOURS DE MARCHANDISE

Si certaines pièces sont manquantes ou reçues endommagées, contactez AMISCO dans les 30 jours suivant votre achat. Toutes les réclamations sous garantie doivent être envoyées chez AMISCO par écrit avec l'original ou une photocopie de l'original de la facture. AMISCO se réserve le droit de vérifier le fondement de la réclamation et de demander des pièces justificatives. Les produits défectueux ne doivent pas être retournés chez AMISCO avant d'avoir reçu une autorisation écrite et les instructions d'expédition. AMISCO se réserve le droit de remplacer des produits considérés défectueux par des produits similaires ou de même valeur si les produits originaux ne sont plus disponibles.

REVÊTEMENTS DE PEINTURE

Les produits de métal AMISCO sont recouverts d'une peinture en poudre cuite, qui leur confère une fini durable, respectueux de l'environnement et adapté à une utilisation intérieure.

FINI SEMI-TRANSPARENT HARLEY (51)

Grâce à ce revêtement, il n'existe pas deux meubles identiques. En effet, en laissant voir les cordons de soudure, le sablage et autres procédés, ce fini met en valeur la finesse et l'originalité des artisans d'AMISCO. Une certaine décoloration du métal à divers endroits ne devrait pas être considérée comme une imperfection.

Garantie en vigueur sur les produits vendus après le 1^{er} avril 2019.



FAQ

We want to give you as much information as possible on our products and services. If, for some reasons, there are still unanswered questions, feel free to contact our Customer Service Department. We will get back to you shortly.

- 1 **Is it possible to purchase Amisco products online?**
Amisco does not sell products directly to consumers on Internet. However, many retailers sell Amisco products on their own website.
- 2 **Is it possible to purchase Amisco products directly from the factory?**
It is not possible to purchase Amisco products directly from the factory. Our products are available through different retailers in your area. Please refer to the "Find a retailer" section on our website.
- 3 **I am interested by an Amisco product that I have seen on your website. Where can I see it and try it?**
The retailers do not carry all products on their floor. Check with the retailers in your area to see if they have a particular product in their showroom. Consult the "Find a retailer" section of our website to find your retailer.
- 4 **Can Amisco products be used outdoors?**
Amisco products are designed and made only for an indoor residential use.
- 5 **Are the Amisco products made for commercial use such as restaurant, hotel or public place?**
Amisco products are designed and made for an indoor residential use only, not for a commercial use.
- 6 **Are all the products available in all the finishes and coverings?**
Yes, unless otherwise stated in the product sheet.
- 7 **Are the Amisco products assembled?**
All Amisco products require some assembly, still less than an imported product. For quick references, you can refer to the assembly instructions posted on each page of the products shown on our website www.amisco.com. You can also ask your retailer for the service assembly since it is offered by many of them.

SWIVEL STOOL ASSEMBLY INSTRUCTIONS:

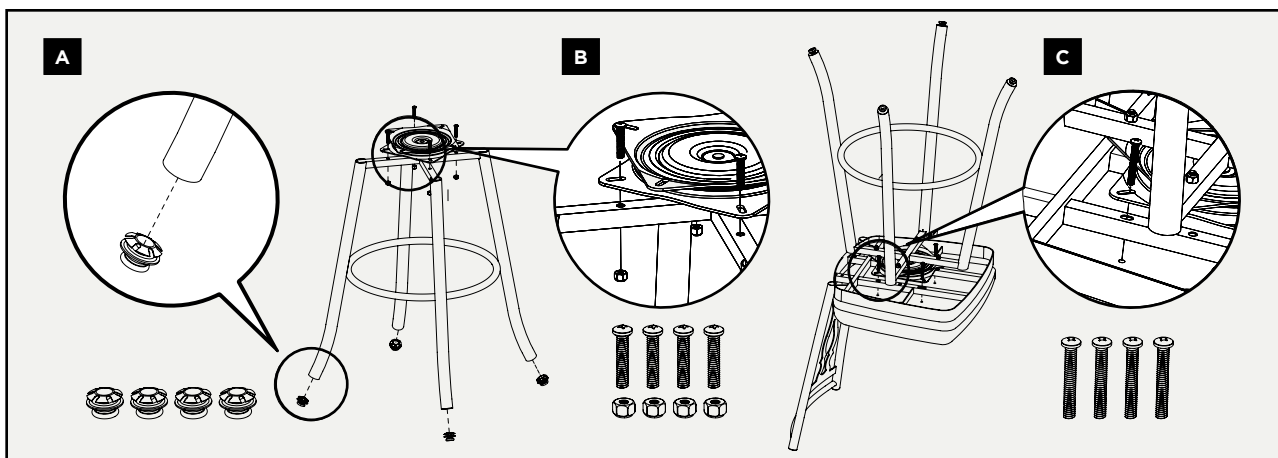

Nous nous efforçons de vous donner le plus d'information possible sur nos produits et services. Si vous avez des questions qui restent sans réponse, contactez notre Département du service à la clientèle qui se fera un plaisir de vous répondre rapidement.

Peut-on acheter les produits Amisco en ligne?
Amisco ne vend pas de produits directement aux consommateurs sur Internet. Cependant, plusieurs détaillants vendent des produits Amisco sur leur site Internet.

Peut-on acheter les produits Amisco directement à l'usine?
Il n'est pas possible d'acheter directement d'Amisco. Amisco ne vend qu'à travers son réseau de détaillants. Pour trouver un détaillant près de chez vous, référez-vous à la section "Trouver un détaillant" de notre site Internet.

J'ai vu un produit Amisco qui m'intéresse sur votre site Internet. Où puis-je le voir et l'essayer?

Les détaillants ne gardent pas sur leur plancher de vente tous les modèles offerts par Amisco. Vérifiez auprès des détaillants de votre région s'ils ont le produit que vous recherchez en consultant la section "Trouver un détaillant" de notre site Internet.

Les produits Amisco peuvent-ils être utilisés à l'extérieur?
Les produits Amisco sont conçus et fabriqués seulement pour un usage résidentiel intérieur.

Les produits Amisco peuvent-ils être utilisés dans un restaurant, hôtel ou un lieu public?
Les produits Amisco sont conçus et fabriqués pour un usage résidentiel intérieur, et non pour un usage commercial.

Est-ce que tous les produits sont disponibles dans tous les finis et recouvrements?
Oui, sauf si indication contraire sur la fiche du produit.

Les produits Amisco sont-ils assemblés?
Les produits Amisco requièrent un léger assemblage, moindres qu'un produit importé. Pour références rapides, vous pouvez consulter les instructions qui se retrouvent sur la page du produit montré sur notre site Internet. De plus, plusieurs détaillants offrent le service d'assemblage lorsqu'ils livrent les produits à votre domicile. Informez-vous auprès de votre détaillant.

INSTRUCTIONS DE MONTAGE DU TABOURET PIVOTANT:

8

How should we choose the height of a stool?

If your counter is the same height as your kitchen sink you need a 26" stools.

If your counter is bar height you need 30" stools.

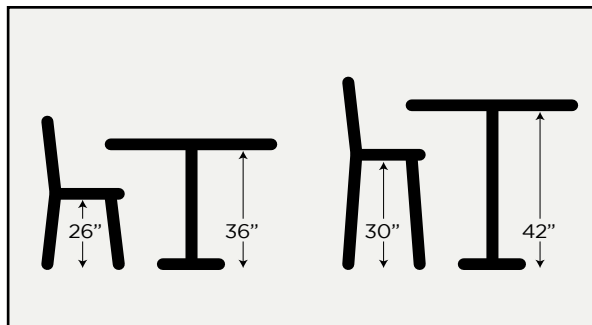
**Comment doit-on choisir la hauteur d'un tabouret ?**

Si votre comptoir est de la même hauteur que votre évier de cuisine, vous avez besoin de tabourets 26".

Si votre comptoir est de la hauteur d'un bar, vous avez besoin de tabourets 30".

9

What is the recommended space for each stool?

We recommend allowing 22" to 25" of space for each stool. Be sure to reserve more space for swivel stools or stools with arms.

Quel est l'espace recommandé pour chaque tabouret ?

Nous recommandons d'allouer un espace variant de 22" à 25" de large par tabouret. Il faut prévoir plus d'espace pour un tabouret pivotant ou avec bras.

10

What is the maximum weight the Amisco products can support?

- Chairs and stools: 300 lb
- Accent chairs: 450 lb
- Table bases, set of 4 legs: 250 lb, including tabletop weight*
- Tabletops: 100 lb*
- Benches: 800 lb
- Accent table bases : 250 lb exception of Zuma C table base : 50 lb

* Note: these weights only reflect the load that can be applied without breaking a table. These weights are not maximum weights for a tabletop not made by Amisco.

Quel est le poids maximal pouvant être supporté par les produits Amisco ?

- Chaises et tabourets: 300 lb
- Chaises d'appoint: 450 lb
- Bases de table, jeu de 4 pattes: 250 lb, incluant le poids du dessus de table*
- Dessus de table: 100 lb*
- Bancs: 800 lb
- Tables d'accent : 250 lb à l'exception de la table en C Zuma : 50 lb

* Note: ces poids indiquent seulement la charge que peuvent prendre nos tables ou dessus de table avant de se briser. Ces poids n'indiquent pas le poids que peut avoir un dessus de table qui n'est pas vendu par Amisco.

11

How do we clean an Amisco product?

Steel requires little maintenance. Simply use a soft cloth and mild soapy water. Rinse and wipe dry. Do not use a scouring pad or an abrasive cleanser. This could scratch the paint finish. Refer to the "FAQ/Product Care" section of Amisco's website. You will find all the indications concerning the general maintenance of your Amisco product.

Comment doit-on nettoyer un produit Amisco ?

L'acier nécessite peu d'entretien. Utiliser simplement un chiffon doux et de l'eau savonneuse tiède. Rincer et bien sécher. Ne pas utiliser de tampon à récurer ou de produits de nettoyage abrasif. Ceci pourrait égratigner la peinture. Référez-vous à la section "FAQ/Entretien" de notre site Internet, vous y trouverez toutes les indications concernant l'entretien général de votre produit Amisco.

12

What is your furniture made of?

The Amisco products are mainly made of superior North American steel, formed in Canada, and painted with lead free paint. Some components are made of solid wood (birch or ash), particle board and MDF complying with TSCA Title VI formaldehyde emission limits.

De quoi sont faits vos meubles ?

Les meubles Amisco sont principalement composés d'acier nord-américain de qualité supérieure, façonné au Canada, et peint avec de la peinture sans plomb. Certaines composantes sont faites de bois franc (merisier ou frêne) de panneaux particules et de MDF respectant les limites d'émission de formaldéhyde TSCA Title VI.

13

Can we have the price of a product?

Only retailers can give you prices for an Amisco product. Prices may differ from a retailer to another.

Peut-on connaître le prix d'un produit ?

Seul un détaillant peut vous donner le prix d'un produit Amisco. Le prix peut différer d'un détaillant à l'autre.

14

Can we get a catalogue of your products?

A PDF of our catalogues is available in the Product Info / PDF Catalogue section of our website.

Peut-on se procurer un catalogue de vos produits ?

La version PDF de notre catalogue est disponible dans la section Info produits / Catalogues PDF de notre site Internet.

15

To which dimensions refer your measuring codes?

Our measuring codes refer to the following dimensions:

W (width) **D** (depth) **H** (height) **S** (seat height) **A** (arms height)

À quoi correspondent vos codes de mesures ?

Nos codes de mesures réfèrent aux dimensions suivantes:

L (largeur) **P** (profondeur) **H** (hauteur) **S** (hauteur du siège) **A** (hauteur des appuis-bras)

16

Can I use a marble, quartz or granite tabletop on an Amisco table base?

No. The stability, height and sturdiness of a table which do not use a tabletop recommended by Amisco cannot be warranted. Before ordering, please refer to the grid on pages 316-319-323 for alternative styles and sizes of tabletops available.

Puis-je mettre un dessus de marbre, quartz ou de granit sur une base de table Amisco ?

Non. Amisco peut garantir la stabilité, la hauteur et la solidité d'une table seulement si elle est constituée d'une combinaison de base et de dessus de table recommandée par Amisco. Avant de placer une commande, veuillez vous référer à la grille aux pages 316-319-323 pour connaître les autres dimensions et styles de dessus de table disponibles.

17

Are the glass tabletops tempered?

No, unless otherwise stated on the product sheet.

Les dessus de verre sont-ils trempés ?

Non, sauf indication contraire dans la fiche du produit.

- 18** **Is a fabric protector (ex: Scotchgard™) applied on your upholstered products?**
No. A lot of the coverings do not require it due to their waterproof characteristics: the PVC, polyurethanes and some nylon velvets. The others can be cleaned easily. Many retailers offer the fabric protector application service. Please ask your retailer.
- 19** **Can we purchase an upholstered product with two different coverings?**
Unfortunately it is not possible to combine different coverings on a same product.
- 20** **Can we purchase a chair or a stool with a wood seat?**
Every product that is available with a solid wood seat is listed in this catalogue.
- 21** **Can we purchase a swivel stool made up of a base model X and a backrest model Y?**
No. The Amisco designers chose the best bases and backrests combinations possible to create each model.
- 22** **Are your products safe?**
At Amisco, we place a premium on the design and production of safe furniture. Our safety standards are among the highest in the industry. Our lead-free paints meet U.S. CPSIA and Health Canada regulations, and the particle board and MDF used to manufacture our products meet formaldehyde emission limits TSCA Title VI, the most stringent in North America. So, our customers know they can use Amisco furniture in confidence.
- 23** **How can I get replacement hardware and/or glides?**
Do you need replacement hardware and/or glides for your Amisco product? Visit our website and select the concerned product. At the bottom of the product page, you will find the link "Replacement Hardware and/or Glides". Click on the link and fill out the form. You will receive your parts as soon as possible.

If you cannot find the product you purchased or if you hesitate, contact our Customer Service Department who can help you.
- 24** **Do you deliver to retailers?**
Service excellence is second nature at Amisco, even during order deliveries. We select the best shipping companies to ensure that the products arrive under optimal conditions to our retailers.
- 25** **What is the Unfinished wood color?**
The Unfinished wood color (85 for non-distressed birch and 45 for distressed solid birch) can be ordered when you wish to stain the wood component yourself. This color is only available on non-distressed solid wood or distressed solid wood accents and seats. The Unfinished wood components must be finished.

Est-ce qu'un protecteur à tissu (ex.: Scotchgard™) est appliqué sur vos produits rembourrés?

Non. Plusieurs des recouvrements n'en requièrent pas, de par leur propriété hydrofuge: les Vinyons, les polyuréthanes et certains velours de nylon. Les autres peuvent se nettoyer facilement. Plusieurs détaillants offrent le service d'application d'un protecteur à tissu. Informez-vous auprès de votre détaillant.

Peut-on acheter un produit rembourré avec deux recouvrements différents?

Malheureusement, il n'est pas possible de combiner plusieurs recouvrements sur un même produit.

Peut-on acheter des chaises et des tabourets avec un siège en bois?

Tous les produits disponibles avec un siège de bois massif figurent dans ce catalogue.

Peut-on acheter un tabouret pivotant constitué de la base du modèle X et du haut du modèle Y?

Non. Les designers d'Amisco ont choisi les meilleures combinaisons de bases et de dossiers possibles pour créer chaque modèle.

Est-ce que vos produits sont sécuritaires?

Concevoir et fabriquer des meubles sécuritaires, Amisco en fait un impératif. Nos normes de sécurité sont parmi les plus élevées de l'industrie. Nos peintures sans plomb sont conformes à la réglementation du CPSIA américain et de Santé Canada. Les panneaux de particules et de MDF nécessaires à la fabrication de nos produits rencontrent les limites d'émission de formaldéhyde TSCA Title VI, les plus exigeantes en Amérique du Nord. Ainsi, tous nos clients sont assurés d'une utilisation en toute quiétude de nos meubles.

Comment peut-on se procurer de la quincaillerie ou des glisseurs de remplacement?

Vous avez besoin de quincaillerie ou de glisseurs de remplacement pour votre produit Amisco? Consultez notre site internet et sélectionnez le produit concerné. Au bas de la page du produit, vous trouverez le lien « Réclamation de quincaillerie et de glisseurs ». Cliquez sur le lien et remplissez le formulaire. Vous recevrez vos pièces dans les plus brefs délais.

Si vous ne trouvez pas le produit que vous avez acheté ou si vous hésitez, contactez notre Département du service à la clientèle qui pourra vous aider.

Offrez-vous un service de livraison aux détaillants?

Amisco se distingue par l'excellence de son service jusqu'à la livraison de ses produits aux détaillants. Ainsi, nous sélectionnons les meilleurs transporteurs afin de vous garantir une livraison dans des conditions optimales.

Qu'est-ce que la couleur de bois Non peint?

La couleur de bois Non peint (85 pour le merisier non usé et 45 pour le merisier massif usé) peut être commandée si vous désirez teindre la composante de bois vous-même. Cette couleur est uniquement disponible sur les accents et sièges de bois massif non usé ou de bois massif usé. Le fini Non peint ne peut pas demeurer sans finition.

26

What are the characteristics of the Harley (51) semi-transparent finish?

The inherent characteristics of this finish allow the darkening of the construction welds and seams to show through, which makes each piece truly unique.

Quelles sont les particularités du fini semi-transparent Harley (51)?

La particularité de ce fini semi-transparent est de laisser entrevoir le noircissement créé par le procédé de soudure, ce qui rend chaque pièce vraiment unique.

Color variations / Variations dans la couleur

Paint thickness variation is inherent to our paint application process. The differences in paint thickness cause color variations, which may vary from a light copper tint to a dark brown on the same product. These color changes provide to this finish a warm and unique look.

Des variations d'épaisseurs de peinture sont inhérentes à notre procédé d'application de peinture. Ces dernières engendrent des variations de couleurs, qui peuvent aller d'une teinte claire et cuivrée à un brun foncé sur un même produit. Ces nuances de couleurs rendent ce fini très chaleureux et unique.

Weld seam along tubes / Soudures le long des tubes

A continuous black line may appear along a tube. This is the area where the steel was welded to become a tube. The tube weld seam may appear on any given face of a tube or of a product.

Une ligne plus foncée peut être apparente tout le long d'un tube. C'est l'endroit où l'acier a été soudé pour devenir un tube. La ligne de soudure sur les tubes peut être apparente sur n'importe quelle face du tube ou du produit.

Visible welds / Soudures apparentes

When welding, metal heats up and darkens. Dark spots may be visible around welds, as well as on the face of a sheet metal part opposite to a weld.

En soudant, le métal chauffe et se noircit. Des taches foncées peuvent être apparentes autour des soudures, ainsi que sur le côté opposé à une soudure sur une tôle.

Buffer marks
Traces de sablage



Spots on steel
Taches sur l'acier



Manual characteristics **that will appear** on distressed solid wood components
Marques d'usure manuelles présentes sur les composantes de bois massif usé

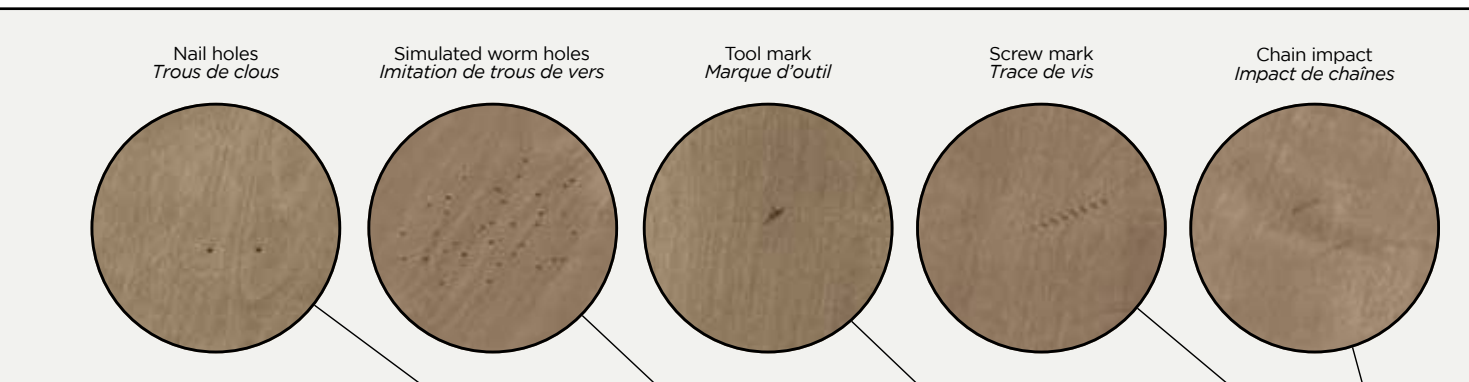

27 **What are the characteristics of the distressed solid birch?**
 Celebrating character marks, knots and contrasting wood grain, distressed solid birch blends incredibly well with steel, providing an authentic and unique look to every product.

Distressed solid birch only available when mentioned in the product description.

28 **What are the characteristics of the solid wood (birch and ash)?**
 Wood is a natural, strong and durable material. Solid wood has distinct markings, such as veins, knots, and color variations between planks, which distinguishes it from synthetic products.

Wood is a material that continues to live in your environment and will adjust to the conditions of your home. Seasonal humidity and temperature changes can affect the appearance and size of your product, which should be considered as normal.

To prevent damage to your wood product and to ensure your comfort, it is important to maintain a relative humidity between 30% and 50% in your home.

Please avoid placing the table or its extensions near a source of intense heat.

To preserve your product original color, please avoid placing it in direct sunlight.

Natural characteristics **that may appear** on solid wood components
*Marques naturelles **pouvant se retrouver** sur les composantes de bois massif*

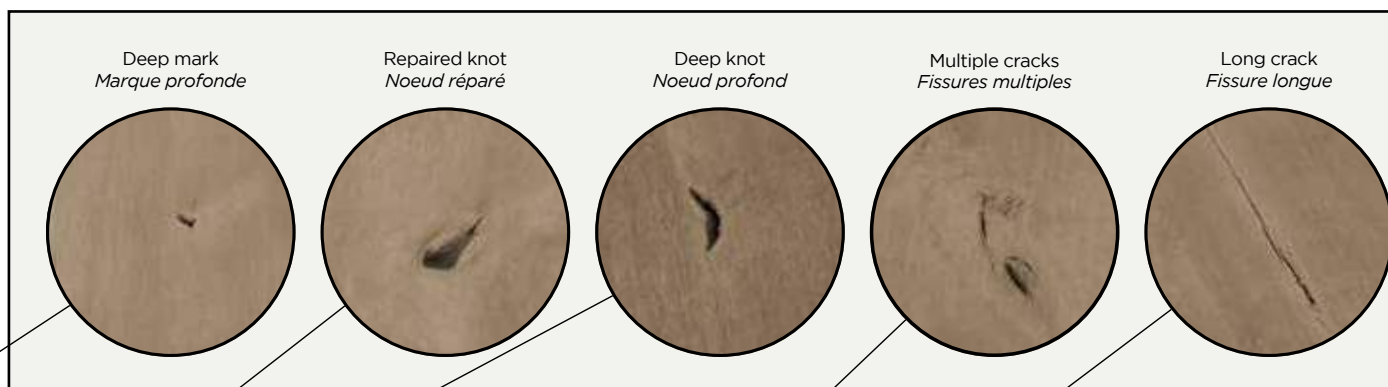

Quelles sont les caractéristiques du merisier massif usé ?

Faisant l'éloge des nœuds, des marques de caractère et du grain de bois contrasté, le merisier massif usé s'agence incroyablement bien avec le métal, conférant un look unique et authentique à chaque produit.

Merisier massif usé uniquement disponible lorsque mentionné dans le descriptif de produit.

Quelles sont les caractéristiques du bois massif (merisier et le frêne) ?

Le bois est une matière naturelle, solide et durable. Le bois solide comporte des marques distinctes, tel que du veinage, des nœuds ainsi que des variations de couleurs entre chaque planche, ce qui le distingue des produits synthétiques.

Le bois est une matière qui continue de vivre, qui s'ajuste aux conditions de votre maison. Le taux d'humidité ainsi que les changements de température reliés à nos saisons peuvent affecter l'apparence et les dimensions de votre produit, ce qui est tout à fait normal.

Pour prévenir des dommages à votre produit de bois et pour assurer votre confort, il importe de maintenir une humidité relative entre 30% et 50% dans votre maison.

Veillez éviter de placer la table ou ses rallonges près d'une source de chaleur intense.

Pour contribuer à préserver la couleur d'origine du produit, veuillez éviter de l'exposer directement aux rayons du soleil.

Numerical Index / *Index numérique*



30103 Payton
P. 196



30123 Crescent
P. 166



30123B Crescent
P. 166



30124 Tori
P. 201



30124B Tori
P. 121, 201



30132 Opus
P. 192



30137 Jonas
P. 179



30144 Tori
P. 121, 201



30144B Tori
P. 202



30151 Marcus
P. 187



30154 Owen
P. 58, 99, 194



30154B Owen
P. 194



30202 Hint
P. 92, 178



30223 Dexter
P. 108, 168



30223B Dexter
P. 108, 168



30227B Angelina
P. 152



30263 Architect
P. 103, 154



30263B Architect
P. 154



30268 Bean
P. 157



30268B Bean
P. 157



30272 Architect
P. 208



30272B Architect
P. 208



30273 Architect
P. 103, 208



30273B Architect
P. 208



30293 Lauren
P. 182



30317 Luna
P. 40, 186



30320 Linea
P. 63, 185



30321 Curve
P. 67, 167



30322 Merlot
P. 99, 189



30325 Level
P. 184



30330 Webber
P. 83, 139, 204



30331 Osten
P. 35, 39, 193



30333 Bray
P. 37, 161



30334 Zahra
P. 72, 79, 206



30336 Benson
P. 71, 160



30337 Gladys
P. 30, 175



30340 Mathilde
P. 16, 188



30341 Maddie
P. 15, 186



30342 Zola
P. 38, 207



30343 Essie
P. 24, 172



30344 Scarlett
P. 199



30345 Cassandra
P. 138, 164



30346 Atria
P. 125, 156



30348 Nestor
P. 69, 191



30350 Milanos
P. 128, 133, 189



30351 Niles
P. 128, 133, 191



30353 Waverly
P. 81, 203



30354 Bellamy
P. 85, 159



30408 Upright
P. 212



30408B Upright
P. 212



30409 Dryden
P. 210



30409B Dryden
P. 210



30410 Upright
P. 13, 116, 212



30410B Upright
P. 212



30419 Dryden
P. 59, 210



30419B Dryden
P. 210



30425 Munich
P. 213



30444 Benson
P. 209



30444B Benson
P. 209



30446 Benson
P. 72, 209



30446B Benson
P. 209



30472 Pablo
P. 211



30473 Pablo
P. 105, 211



30474 Monroe
P. 51, 211



30478 Monroe
P. 211



30493 Lauren
P. 182



30534 Weston
P. 141, 205



30535 Easton
P. 49, 59, 170



30536 Brixton
P. 109, 162



30537 Giulia
P. 127, 175



30539 Sorrento
P. 54, 200



30560 Grissom
P. 94, 176



30561 Grissom Plus
P. 94, 177



30563 Architect
P. 104, 154



30563B Architect
P. 155



30568 Bean
P. 158



30568B Bean
P. 118, 158



30570 Wilbur
P. 88, 206



30571 Phoebe
P. 45, 197



30573 Darlene
P. 134, 168



30574 Darcy
P. 134, 167



30575 Bridget
P. 161



30593 Lauren
P. 182



30593B Lauren
P. 182



35198 Edwin
P. 170



35198B Edwin
P. 117, 170



35210 Eleanor
P. 172



35214 Kyle
P. 180



35214B Kyle
P. 119, 180



35219 Annabelle
P. 153



35219B Annabelle
P. 153



35304 Pablo
P. 105, 116, 195



35305 Leo
P. 184



35308 Pedro
P. 13, 98, 196



35309 Alto
P. 105, 152



35404 Monroe
P. 51, 190



35405 Mitchell
P. 190



35408 Melrose
P. 51, 188



35409 Marlon
P. 187



40033 Nathan
P. 62, 190



40035 Miller
P. 18, 189



40038 Bradley
P. 160



40038-B Bradley
P. 115, 160



40039 Aaron
P. 53, 151



40039-B Aaron
P. 151



40043 Allegro
P. 129, 151



40043-B Allegro
P. 151



40044 Fred
P. 64, 174



40044-B Fred
P. 174



40103 Payton
P. 196



40123 Crescent
P. 166



40123-B Crescent
P. 167



40132 Opus
P. 192



40198 Edwin
P. 171



40198-B Edwin
P. 117, 171



40202 Hint
P. 89, 178



40224 Kyle
P. 180



40224-B Kyle
P. 181



40227-B Angelina
P. 152



40263 Architect
P. 155



40263B Architect
P. 155



40264 Upright
P. 114, 202



40264-B Upright
P. 202



40293 Lauren
P. 183



40317 Luna
P. 43, 186



40320 Linea
P. 185



40323 Dexter
P. 169



40323-B Dexter
P. 107, 169



40329 Osten
P. 193



40331 Osten
P. 36, 193



40336 Outback
P. 75, 194



40340 Mathilde
P. 17, 188



40342 Zola
P. 50, 207



40345 Cassandra
P. 164



40346 Atria
P. 126, 157



40347 Otis
P. 23, 193



40348 Nestor
P. 70, 191



40350 Milanos
P. 130, 189



40353 Waverly
P. 80, 204



40354 Bellamy
P. 84, 159



40355 Sonoma
P. 29, 200



40493 Lauren
P. 183



40563 Architect
P. 155



40563B Architect
P. 106, 156



40573 Darlene
P. 137, 168



40574 Darcy
P. 167



40575 Bridget
P. 14, 161



40593 Lauren
P. 183



40593-B Lauren
P. 183



41212 Fletcher
P. 77, 174



41219 Zao
P. 74, 207



41230 Noah
P. 44, 192



41234 Collin
P. 20, 164



41239 Joshua
P. 86, 179



41253 Visconti
P. 76, 203



41257 Wayne
P. 204



41268 Bean
P. 158



41268-B Bean
P. 122, 158



41273 Esteban
P. 172



41273-B Esteban
P. 97, 173



41297 Diaz
P. 131, 169



41317 Luna
P. 186



41320 Linea
P. 60, 185



41321 Linea
P. 31, 185



41325 Level
P. 61, 184



41330 Webber
P. 140, 204



41333 Bray
P. 34, 161



41334 Zahra
P. 78, 206



41336 Benson
P. 73, 160



41344 Scarlett
P. 143, 199



41351 Niles
P. 132, 191



41405 Brittany
P. 162



41406 Madison
P. 187



41410 Eleanor
P. 172



41414 Kyle
P. 181



41414-B Kyle
P. 119, 181



41419 Annabelle
P. 153



41419-B Annabelle
P. 153



41430 Cardin
P. 163



41435 Brock
P. 52, 162



41436 Lance
P. 181



41437 Jonas
P. 179



41442 Ronny
P. 65, 198



41444 Bryce
P. 62, 163



41445 Barry
P. 52, 157



41451 Marcus
P. 146, 187



41454 Owen
P. 194



41468 Fame
P. 173



41478 Lincoln
P. 33, 184



41488 Garden
P. 147, 174



41498 Edwin
P. 171



41498-B Edwin
P. 171



41510 Oxford
P. 148, 195



41512 Whisky
P. 149, 205



41519 Carson
P. 93, 164



41526 Russell
P. 111, 199



41528 Kent
P. 112, 179



41528-B Kent
P. 180



41534 Weston
P. 144, 205



41535 Easton
P. 56, 170



41536 Brixton
P. 110, 162



41537 Radcliff
P. 197



41539 Sorrento
P. 57, 200



41557 Radcliff
P. 198



41560 Grissom
P. 91, 177



41563 Costa
P. 25, 165



41568 Bean
P. 159



41568-B Bean
P. 159



41569 Positano
P. 55, 197



41570 Wilbur
P. 87, 88, 206



41571 Phoebe
P. 42, 197



41575 Sunny
P. 124, 201



41578 Wembley
P. 136, 205



41581 Umbria
P. 202



41596 Dorsey
P. 19, 169



41597 Glenn
P. 135, 175



42231 Anton
P. 66, 154



42334 Zip
P. 41, 207



42344 Skyla
P. 27, 199



42344-B Skyla
P. 22, 200



42414 Grace
P. 176



42414-B Grace
P. 176



42436 Reel
P. 198



42442 Rudy
P. 46, 198



42460 Button
P. 95, 163



42460-B Button
P. 163



42493 Connor
P. 165



42493-B Connor
P. 165



42463 Costa
P. 165



42463-B Costa
P. 25, 166



42495 Glint
P. 28, 176



42504 Hans
P. 47, 177



42504-B Hans
P. 177



42514 Pearl
P. 196



42534 Nox
P. 90, 192



42563 Architect
P. 120, 156



42563B Architect
P. 156



42564 Upright
P. 203



42564-B Upright
P. 100, 203



42593 Anders
P. 152



42597 Glenn
P. 175



45304 Pablo
P. 195



45305 Pablo Plus
P. 195



45308 Ethan
P. 113, 142, 173



45309 Ethan Plus
P. 101, 173



45404 Monroe
P. 190



45405 Hanson Plus
P. 178



45408 Melrose
P. 188



45409 Hanson
P. 178



50161-14 Zuma
P. 82, 229



50161-20 Zuma
P. 82, 229



50164 Crawford
P. 48, 217



50165 Elwood
P. 100, 102, 219



50262 Jill
P. 32, 221



50264 Crawford
P. 46, 48, 217



50265 Elwood
P. 100, 102, 220



50266 Malloy
P. 224



50362 Jill
P. 32, 222



50364 Crawford
P. 48, 218



50365 Elwood
P. 102, 220



50366 Malloy
P. 225



50403 Maya
P. 26, 227



50404 Maya
P. 26, 227



50406 Maya
P. 26, 228



50461 Zuma
P. 82, 230



50462 Jill
P. 223



50464 Crawford
P. 216



50465 Elwood
P. 218



50466 Malloy
P. 226



50507 Dalia
P. 255



50507-38/42 Dalia
P. 136, 255



50514 Belleville
P. 139, 237



50516 Tacoma
P. 105, 108, 297



50522 Zoom
P. 39, 58, 63, 308



50524 Nexus
P. 67, 281



50531 Richview
P. 51, 85, 88, 92, 294



50532 Hendrick
P. 49, 79, 261



50533 Boomerang
P. 94, 241



50535 Lexington
P. 13, 267



50537-38/42 Aden
P. 42, 115, 231



50547 Dalia XL
P. 256



50550 Judy
P. 262



50550-36/42 Judy
P. 262



50551 Billy
P. 240



50551-36/42 Billy
P. 240



50552 Link
P. 277



50553 Link
P. 141, 278



50554-36/42 Link
P. 275



50555 Link
P. 83, 276



50557 Burton
P. 30, 45, 59, 81, 242



50559 Parade
P. 98, 289



50562 Southcross
P. 295



50563 Norcross
P. 109, 118, 284



50563-36/42 Norcross
P. 106, 285



50565 Parade
P. 116, 291



50565-36/42 Parade
P. 113, 291



50566 Parade
P. 16, 290



50566-36/42 Parade
P. 290



50567 Southcross
P. 103, 104, 296



50570 Alya
P. 234



50576 Octavia
P. 286



50577 Octavia
P. 287



50578 Octavia
P. 15, 288



50580 Alya
P. 235



50583-PA Lidya
P. 268



50587 Lidya
P. 269



50588 Lidya
P. 270



50589 Lidya
P. 271



50596 Tayra
P. 298



50597 Tayra
P. 299



50598 Tayra
P. 300



50607 Kai
P. 263



50609 Kai
P. 119, 165



50634 Dirk
P. 257



50660 Bennington
P. 69, 238



50660-36/42 Bennington
P. 101, 238



50662 Carbon
P. 253



50662-36/42 Carbon
P. 253



50664 Ricard
P. 121, 292



50664-36/42 Ricard
P. 292



50665 Azilis
P. 38, 236



50665-36/42 Azilis
P. 64, 236



50667 Nicholson
P. 282



50667-36/42 Nicholson
P. 282



50668 Harrison
P. 259



50668-36/42 Harrison
P. 259



50683 Alexis
P.99, 233



50685 Alex
P. 232



50685-36/42 Alex
P. 232



50707/807 Kai
P. 264



50709/809 Kai
P. 266



50734/834 Dirk
P. 258



50764 Crawford
P. 46, 216



50765 Elwood
P.100, 102, 219



50936 Lidya
P. 272



50952 Link
P. 279



50953 Link
P. 54, 125, 280



50960 Bennington
P. 40, 239



50960-36/42 Bennington
P. 239



50962 Carbon
P. 254



50962-36/42 Carbon
P. 254



50964 Ricard
P. 293



50964-36/42 Ricard
P. 293



50967 Nicholson
P.134, 283



50967-36/42 Nicholson
P. 283



50968 Harrison
P. 260



50968-36/42 Harrison
P. 53, 260



50972 Lidya
P. 37, 72, 273



50984 Lidya
P.133, 274



50996 Tayra
P. 301



50997 Tayra
P. 301



50998 Tayra
P. 71, 127, 303



51460 Zoel
P. 304



51520 Calypso
P. 243



51520-36/42 Calypso
P.243



51521 Calypso
P. 244



51522 Calypso
P. 138, 245



51522-36/42 Calypso
P. 245



51523 Calypso
P. 246



51524 Calypso
P. 247



51524-36/42 Calypso
P. 247



51525 Calypso
P. 248



51526 Calypso
P. 249



51526-36/42 Calypso
P. 249



51527 Calypso
P. 250



51528 Calypso
P. 251



51528-36/42 Calypso
P. 251



51529 Calypso
P. 252



51560 Zoel
P. 305



51572 Zoel
P. 24, 306



51584 Zoel
P. 307



52560 Zenith
P. 35, 310



52572 Zenith
P. 311



52584 Zenith
P. 128, 312

Alphabetical Index / *Index alphabétique*

Aaron 40039.....	53, 151	Connor 42493.....	165	Lance 41436.....	181	Owen 30154.....	58, 99, 194
Aden 50537-38/42.....	42, 115, 231	Costa 41563.....	25, 165	Lauren 30293.....	182	Owen 41454.....	194
Alex 50685.....	232	Costa 42463.....	25, 165, 166	Lauren 30493.....	182	Oxford 41510.....	148, 195
Alex 50685-36/42.....	232	Crawford 50164.....	48, 217	Lauren 30593.....	182	Pablo 30472.....	211
Alexis 50683.....	99, 233	Crawford 50264.....	46, 48, 217	Lauren 40293.....	183	Pablo 30473.....	105, 211
Allegro 40043.....	129, 151	Crawford 50364.....	48, 218	Lauren 40493.....	183	Pablo 35304.....	105, 116, 195
Alto 35309.....	105, 152	Crawford 50464.....	216	Lauren 40593.....	183	Pablo 45304.....	195
Alys 50570.....	234	Crawford 50764.....	46, 216	Leo 35305.....	184	Pablo Plus 45305.....	195
Alys 50580.....	235	Crescent 30123.....	166	Level 30325.....	184	Parade 50559.....	98, 289
Anders 42593.....	152	Crescent 40123.....	166, 167	Level 41325.....	61, 184	Parade 50565.....	116, 291
Angelina 30227.....	152	Curve 30321.....	67, 167	Lexington 50535.....	13, 267	Parade 50565-36/42.....	113, 291
Angelina 40227.....	152	Dalia 50507.....	255	Lidia 50583-PA.....	268	Parade 50566.....	16, 290
Annabelle 35219.....	153	Dalia 50507-38/42.....	136, 255	Lidia 50587.....	269	Parade 50566-36/42.....	290
Annabelle 41419.....	153	Dalia XL 50547.....	256	Lidia 50588.....	270	Payton 30103.....	196
Anton 42231.....	66, 154	Darcy 30574.....	134, 167	Lidia 50589.....	271	Payton 40103.....	196
Architect 30263.....	103, 154	Darcy 40574.....	167	Lidia 50936.....	272	Pearl 42514.....	196
Architect 30272.....	208	Darlene 30573.....	134, 168	Lidia 50972.....	37, 72, 273	Pedro 35308.....	13, 98, 196
Architect 30273.....	103, 208	Darlene 40573.....	137, 168	Lidia 50984.....	133, 274	Phoebe 30571.....	45, 197
Architect 30563.....	104, 154, 155	Dexter 30223.....	108, 168	Lincoln 41478.....	33, 184	Phoebe 41571.....	42, 197
Architect 40263.....	155	Dexter 40323.....	107, 169	Linea 30320.....	63, 185	Positano 41569.....	55, 197
Architect 40563.....	106, 155, 156	Diaz 41297.....	131, 169	Linea 40320.....	185	Radcliff 41537.....	197
Architect 42563.....	120, 156	Dirk 50634.....	257	Linea 41320.....	60, 185	Radcliff 41557.....	198
Atria 30346.....	125, 156	Dirk 50734/834.....	258	Linea 41321.....	31, 185	Reel 42436.....	198
Atria 40346.....	126, 157	Dorsey 41596.....	19, 169	Link 50552.....	277	Ricard 50664.....	121, 292
Azilis 50665.....	38, 236	Dryden 30409.....	210	Link 50553.....	141, 278	Ricard 50664-36/42.....	292
Azilis 50665-36/42.....	64, 236	Dryden 30419.....	59, 210	Link 50554-36/42.....	275	Ricard 50964.....	293
Barry 41445.....	62, 157	Easton 30535.....	49, 59, 170	Link 50555.....	83, 276	Ricard 50964-36/42.....	293
Bean 30268.....	157	Easton 41535.....	56, 170	Link 50952.....	279	Richview 50531.....	51, 85, 88, 92, 294
Bean 30568.....	118, 158	Edwin 35198.....	117, 170	Link 50953.....	54, 125, 280	Ronny 41442.....	65, 198
Bean 41268.....	122, 158	Edwin 40198.....	117, 170	Luna 30317.....	40, 186	Rudy 42442.....	46, 198
Bean 41568.....	159	Edwin 41498.....	171	Luna 40317.....	43, 186	Russell 41526.....	111, 199
Bellamy 30354.....	85, 159	Eleanor 35210.....	172	Luna 41317.....	186	Scarlett 30344.....	199
Bellamy 40354.....	84, 159	Eleanor 41410.....	172	Maddie 30341.....	15, 186	Scarlett 41344.....	143, 199
Belleville 50514.....	139, 237	Elwood 50165.....	100, 102, 219	Madison 41406.....	187	Skyla 42344.....	22, 27, 199, 200
Bennington 50660.....	69, 238	Elwood 50265.....	100, 102, 220	Malloy 50266.....	224	Sonoma 40355.....	29, 200
Bennington 50660-36/42.....	101, 238	Elwood 50365.....	102, 220	Malloy 50366.....	225	Sorrento 30539.....	54, 200
Bennington 50960.....	40, 239	Elwood 50465.....	218	Malloy 50466.....	226	Sorrento 41539.....	57, 200
Bennington 50960-36/42.....	239	Elwood 50765.....	100, 102, 219	Marcus 30151.....	187	Southcross 50562.....	295
Benson 30336.....	71, 160	Essie 30343.....	24, 172	Marcus 41451.....	146, 187	Southcross 50567.....	103, 104, 296
Benson 30444.....	209	Esteban 41273.....	97, 172, 173	Marlon 35409.....	187	Sunny 41575.....	124, 201
Benson 30446.....	72, 209	Ethan 45308.....	113, 142, 173	Mathilde 30340.....	16, 188	Tacoma 50516.....	105, 106, 297
Benson 41336.....	73, 160	Ethan Plus 45309.....	101, 173	Mathilde 40340.....	17, 188	Tayra 50596.....	298
Billy 50551.....	240	Fame 41468.....	173	Maya 50403.....	26, 227	Tayra 50597.....	299
Billy 50551-36/42.....	240	Fletcher 41212.....	77, 174	Maya 50404.....	26, 227	Tayra 50598.....	300
Boomerang 50533.....	94, 241	Fred 40044.....	64, 174	Maya 50406.....	26, 228	Tayra 50996.....	301
Bradley 40038.....	115, 160	Garden 41488.....	147, 174	Melrose 35408.....	51, 188	Tayra 50997.....	302
Bray 30333.....	37, 161	Gladys 30337.....	30, 175	Melrose 45408.....	188	Tayra 50998.....	71, 127, 303
Bray 41333.....	34, 161	Giulia 30537.....	127, 175	Merlot 30322.....	99, 189	Tori 30124.....	121, 201
Bridget 30575.....	161	Glenn 41597.....	135, 175	Milanos 30350.....	128, 133, 189	Tori 30144.....	121, 201, 202
Bridget 40575.....	14, 161	Glenn 42597.....	175	Milanos 40350.....	130, 189	Umbria 41581.....	202
Brittany 41405.....	162	Glint 42495.....	28, 176	Miller 40035.....	18, 189	Upright 30408.....	212
Brixton 30536.....	109, 162	Grace 42414.....	176	Mitchell 35405.....	190	Upright 30410.....	13, 116, 212
Brixton 41536.....	110, 162	Grisson 30560.....	94, 176	Monroe 30474.....	51, 211	Upright 40264.....	114, 202
Brock 41435.....	52, 162	Grisson Plus 30561.....	94, 177	Monroe 30478.....	211	Upright 42564.....	100, 203
Bryce 41444.....	62, 163	Grisson 41560.....	91, 177	Monroe 35404.....	51, 190	Visconti 41253.....	76, 203
Burton 50557.....	30, 45, 59, 81, 242	Hans 42504.....	47, 177	Monroe 45404.....	190	Waverly 30353.....	81, 203
Button 42460.....	95, 163	Hanson 45409.....	178	Munich 30425.....	213	Waverly 40353.....	80, 204
Calyпсо 51520.....	243	Hanson Plus 45405.....	178	Nathan 40033.....	62, 190	Wayne 41257.....	204
Calyпсо 51520-36/42.....	243	Harrison 50668.....	259	Nestor 30348.....	69, 191	Webber 30330.....	83, 139, 204
Calyпсо 51521.....	244	Harrison 50668-36/42.....	259	Nestor 40348.....	70, 191	Webber 41330.....	140, 204
Calyпсо 51522.....	138, 245	Harrison 50968.....	260	Nexus 50524.....	67, 281	Wembley 41578.....	136, 205
Calyпсо 51522-36/42.....	245	Harrison 50968-36/42.....	53, 260	Nicholson 50667.....	282	Weston 30534.....	141, 205
Calyпсо 51523.....	246	Hendrick 50532.....	49, 79, 261	Nicholson 50667-36/42.....	282	Weston 41534.....	144, 205
Calyпсо 51524.....	247	Hint 30202.....	92, 178	Nicholson 50967.....	134, 283	Whisky 41512.....	149, 205
Calyпсо 51524-36/42.....	247	Hint 40202.....	89, 178	Nicholson 50967-36/42.....	283	Wilbur 30570.....	88, 206
Calyпсо 51525.....	248	Jill 50262.....	32, 221	Niles 30351.....	128, 133, 191	Wilbur 41570.....	87, 88, 206
Calyпсо 51526.....	249	Jill 50362.....	32, 222	Niles 41351.....	132, 191	Zahra 30334.....	72, 79, 206
Calyпсо 51526-36/42.....	249	Jill 50462.....	223	Noah 41230.....	44, 192	Zahra 41334.....	78, 206
Calyпсо 51527.....	250	Jonas 30137.....	179	Norcross 50563.....	109, 118, 284	Zao 41219.....	74, 207
Calyпсо 51528.....	251	Jonas 41437.....	179	Norcross 50563-36/42.....	106, 285	Zip 42334.....	41, 207
Calyпсо 51528-36/42.....	251	Joshua 41239.....	86, 179	Nox 42534.....	90, 192	Zoel 51460.....	304
Calyпсо 51529.....	252	Judy 50550.....	262	Octavia 50576.....	286	Zoel 51560.....	305
Carbon 50662.....	253	Judy 50550-36/42.....	262	Octavia 50577.....	287	Zoel 51572.....	24, 306
Carbon 50662-36/42.....	253	Kai 50607.....	263	Octavia 50578.....	15, 288	Zoel 51584.....	307
Carbon 50962.....	254	Kai 50609.....	119, 265	Opus 30132.....	192	Zola 30342.....	38, 207
Carbon 50962-36/42.....	254	Kai 50707/807.....	264	Opus 40132.....	192	Zola 40342.....	50, 207
Cardin 41430.....	163	Kai 50709/809.....	266	Osten 30331.....	35, 39, 193	Zoom 50522.....	39, 58, 63, 308
Carson 41519.....	93, 164	Kent 41528.....	112, 179, 180	Osten 40329.....	193	Zuma 50161-14.....	82, 229
Cassandra 30345.....	138, 164	Kyle 35214.....	119, 180	Osten 40331.....	36, 193	Zuma 50161-20.....	82, 229
Cassandra 40345-26/30.....	164	Kyle 40224.....	180, 181	Otis 40347.....	23, 193	Zuma 50461.....	82, 230
Collin 41234.....	20, 164	Kyle 41414.....	119, 181	Outback 40336.....	75, 194		



Scarlett 30344

Chair / Chaise

Colors shown / Couleurs montrées : Sugar bronze (69) / Cerulean (JK) / Café (43)

Calypso 51521

Table base / Base de table

90840

Wood veneer tabletop (birch) - 40" x 72" oval
Dessus de table en placage de bois (merisier) - 40" x 72" ovale

AMISCO

Amisco Industries Ltd. / Les Industries Amisco Itée

33, 5^e Rue, L'Islet, Québec G0R 2C0 CANADA

T 418 247-5025 / 1 800 361-6360

F 418 247-7896 / 1 800 232-6614

www.amisco.com



QUALITY CANADIAN FURNITURE™
MEUBLES QUALITÉ CANADA™

Eco Amisco

Please recycle this catalogue
S.V.P. Recyclez ce catalogue

PRINTED IN CANADA / IMPRIMÉ AU CANADA

